

A**M277-PAN****24270025/28**

2 / 7

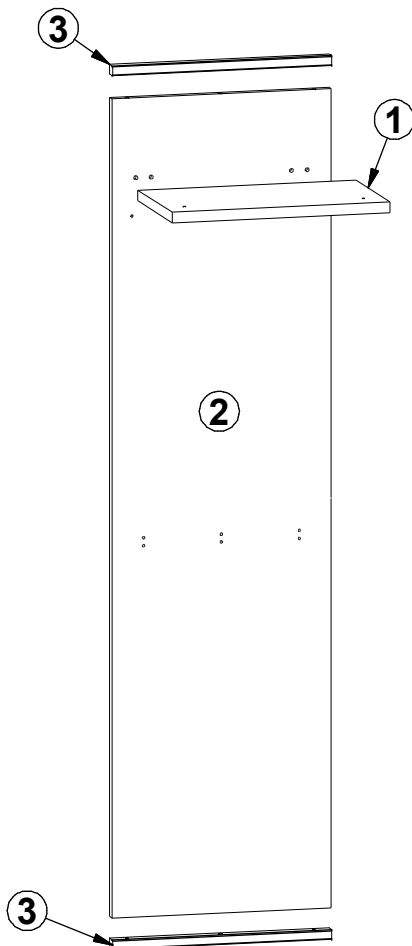

A	B1	B2	C1	C2	C3	C4	D
1	M277-3016	-	448	260	22	1	1/1
2	M277-4501	-	1650	450	16	1	1/1
3	M277-5005	-	451	20	22	2	1/1

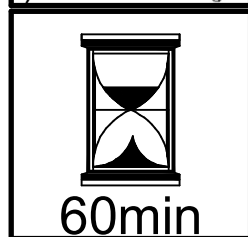
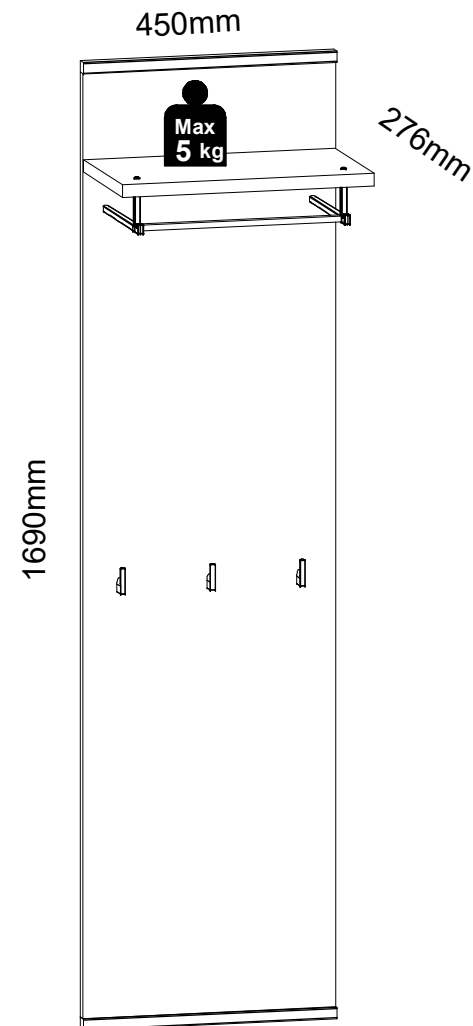
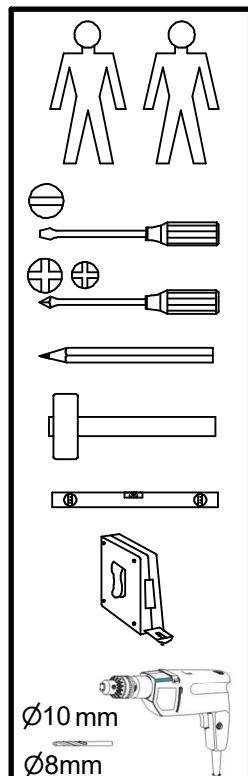

6x Ø5x11 mm e4	2x Ø7x60 mm e8	4x Ø8x30 mm f1	3x Ø10x50 mm f35	3x g2
3x g39	1x g41\4L	1x g41\4P	1x g41\9	2x M4x28 mm j11
8x M4x25 mm j8	3x Ø6x60 mm p75	4x Ø15x12 mm #16 r1	4x 20r11 r42	1x z1
				1x Ø12x0.5 mm s59

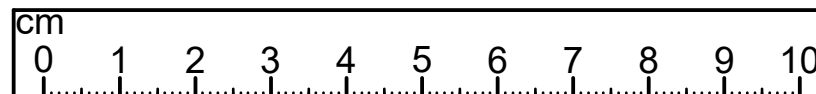

A

M277-PAN

24270025/28

3 / 7

1

4x  20/11 r42	3x  g2	2x  Ø8x30 mm f1	6x  Ø5x11 mm e4	4x  Ø15x12 mm #16 r1
--	---	--	--	---

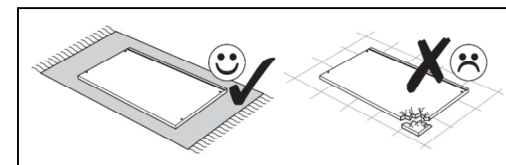
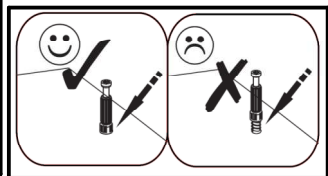
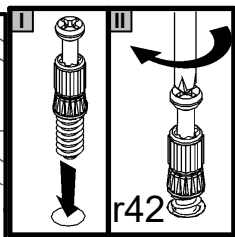
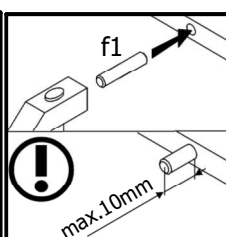
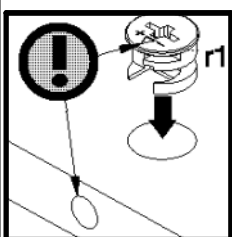
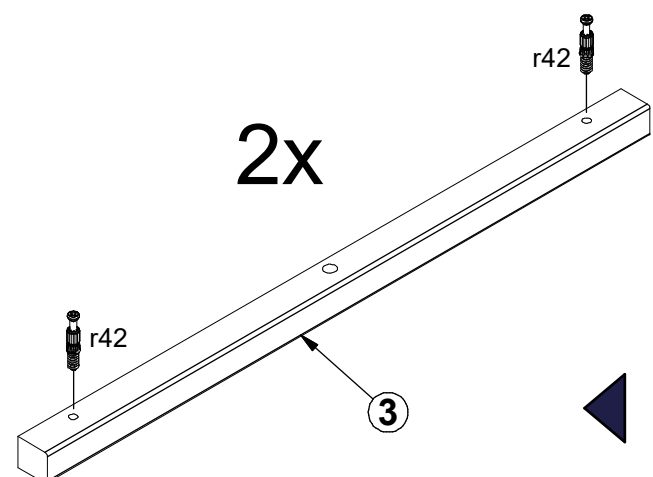
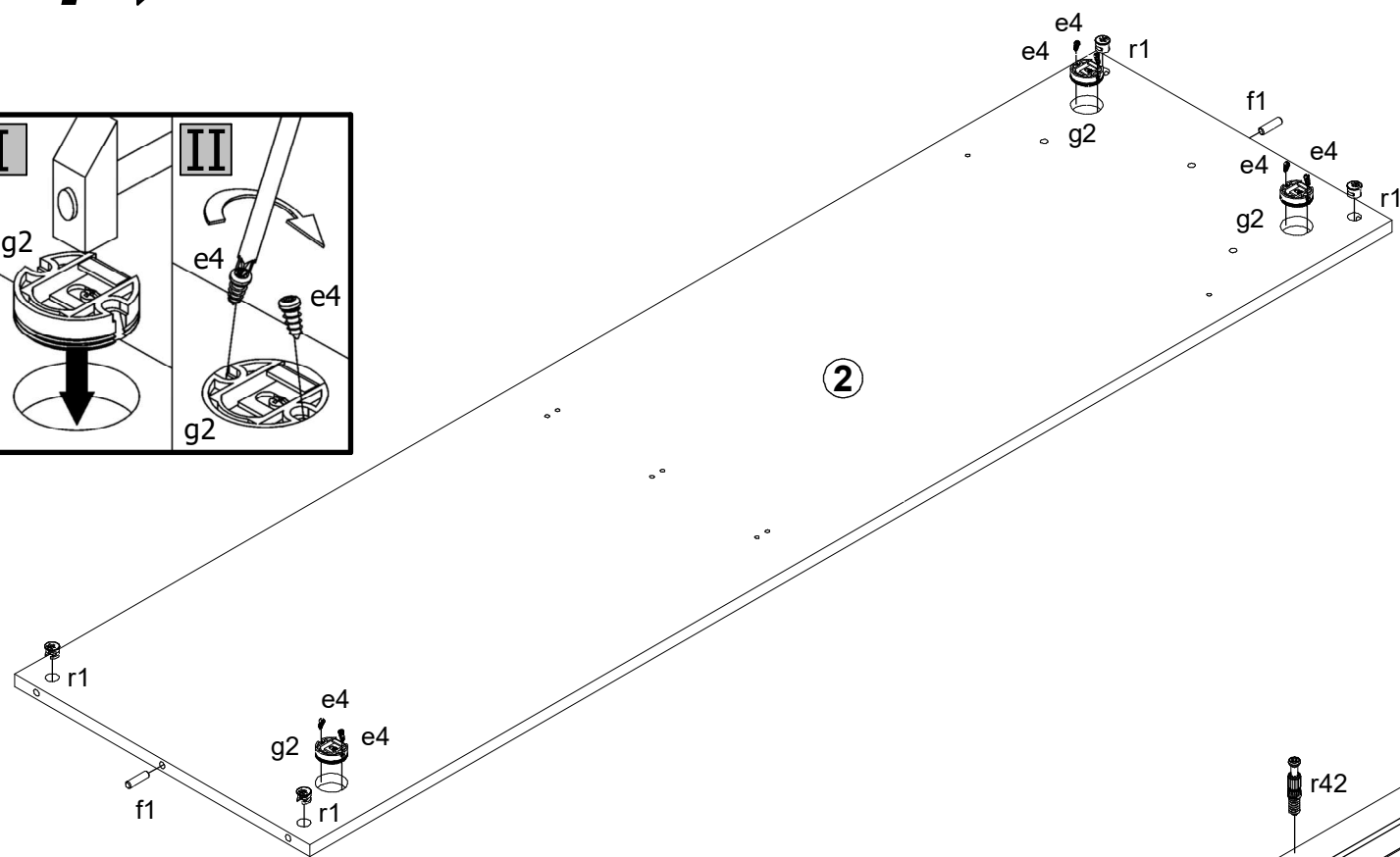
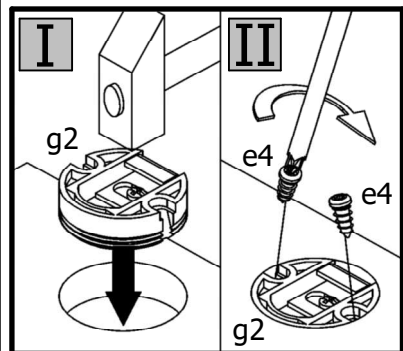

3 ▶

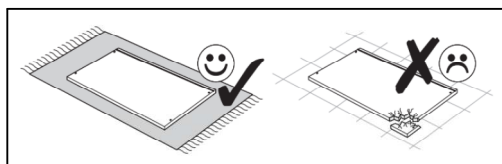
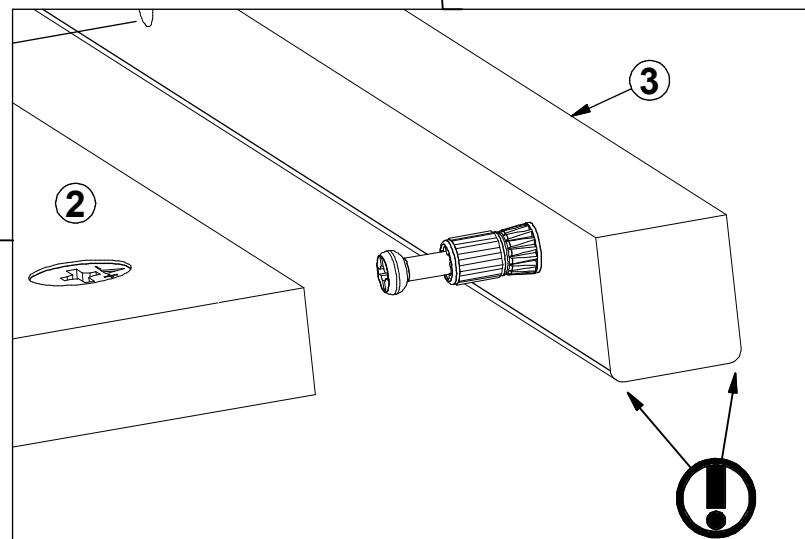
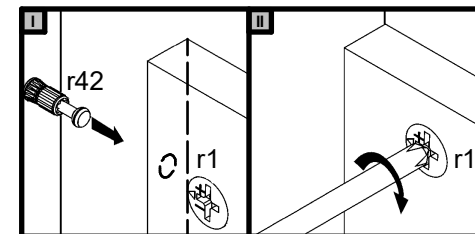
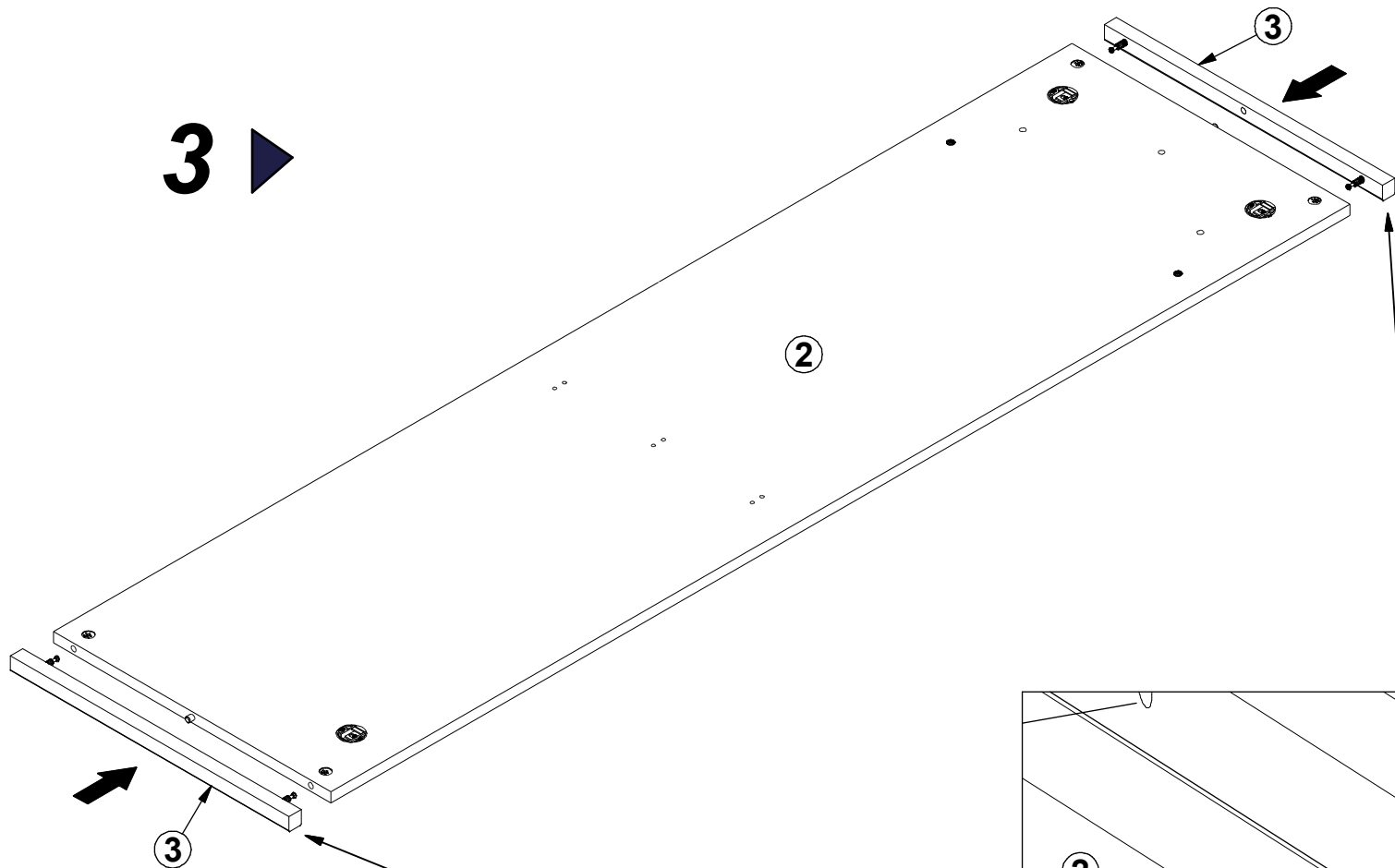

4 ▶

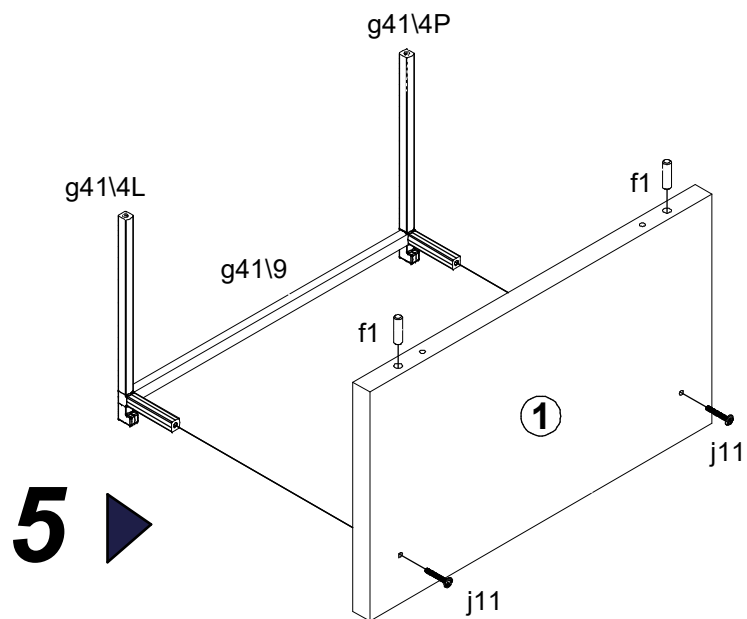
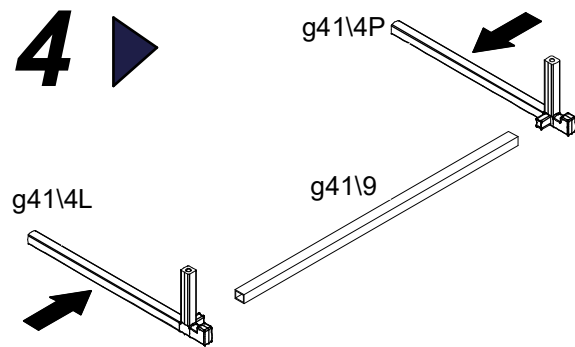

5 ▶

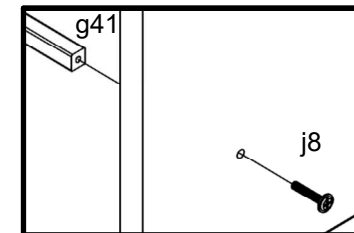
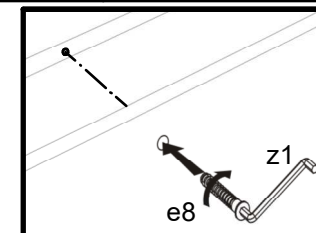
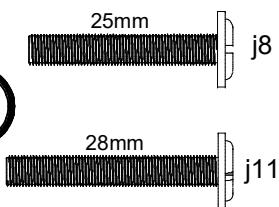
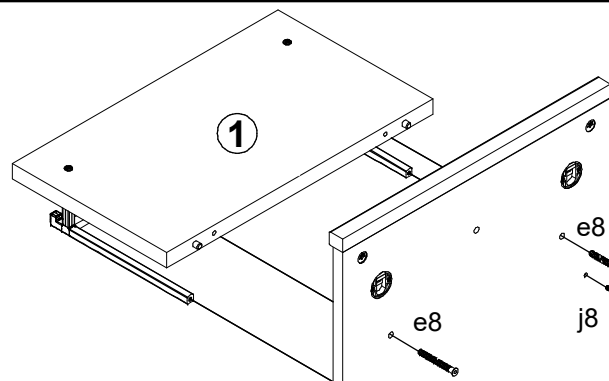

▶ 6

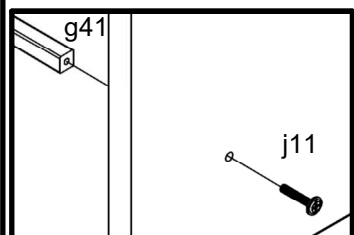

- | | |
|-----------------------|--------------|
| 1x
g41\9 | 1x
g41\4P |
| 2x
M4x28 mm
j11 | 1x
g41\4L |
| 2x
Ø8x30 mm
f1 | |

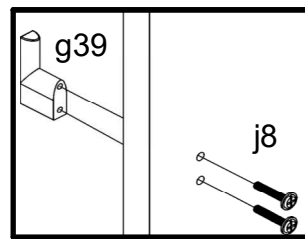
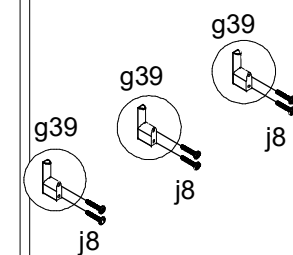
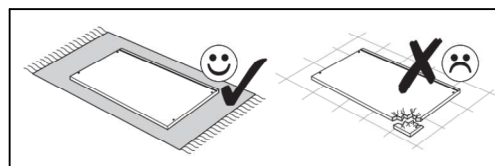

- | |
|----------------------|
| 1x
z1 |
| 2x
Ø7x60 mm
e8 |
| 3x
g39 |
| 8x
M4x25 mm
j8 |

A

M277-PAN

24270025/28

6 / 7

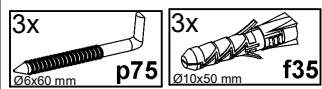
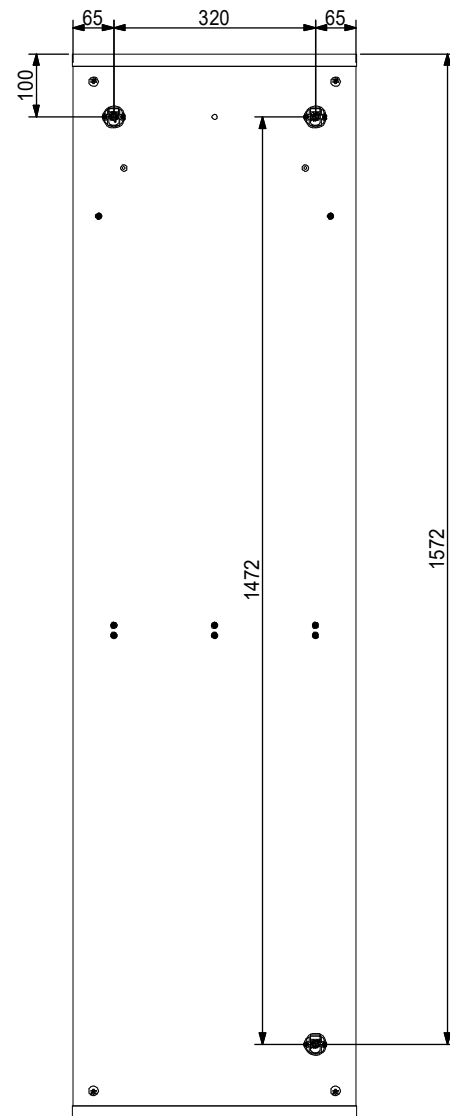
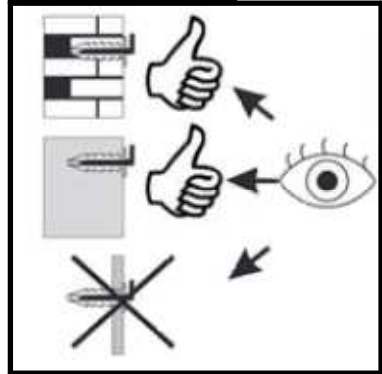
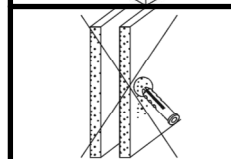
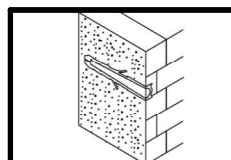
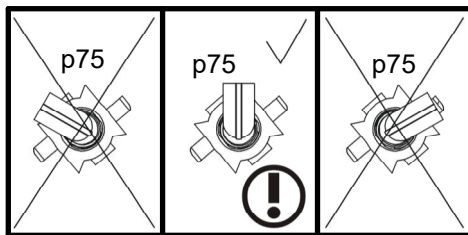
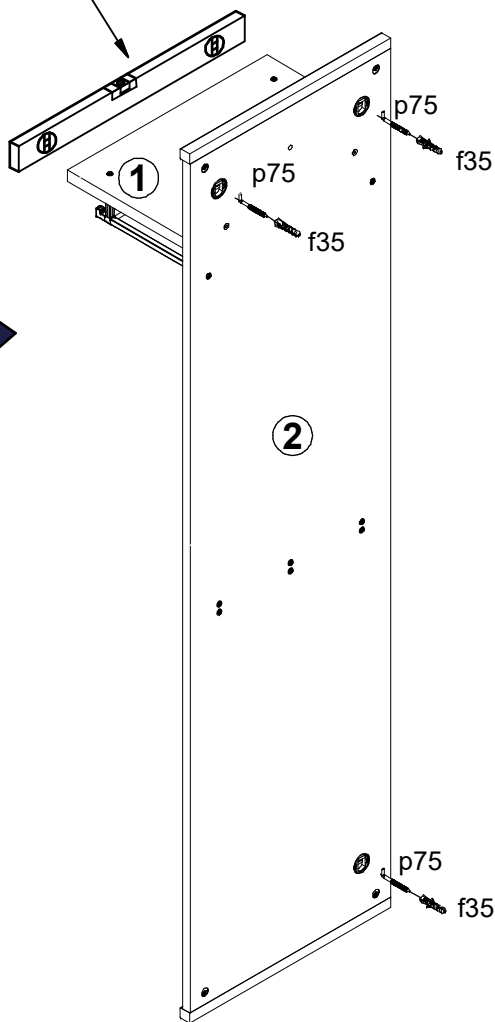
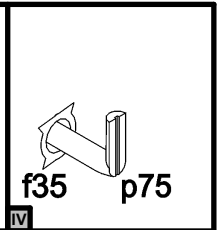
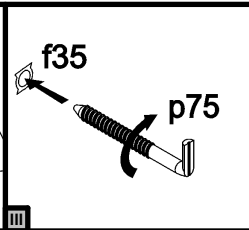
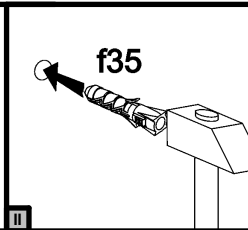
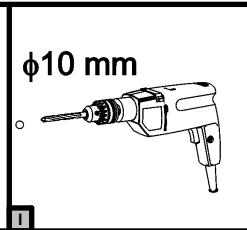
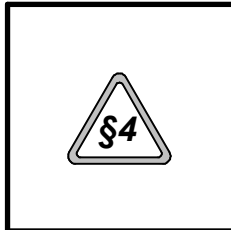
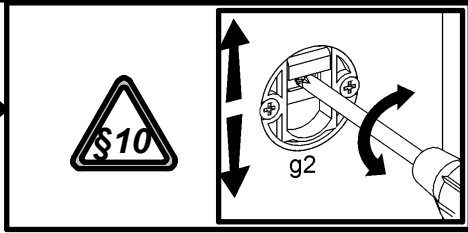
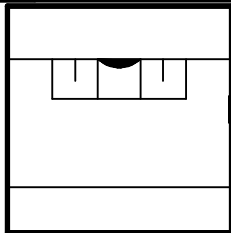

A

M277-PAN

24270025/28

7 / 7

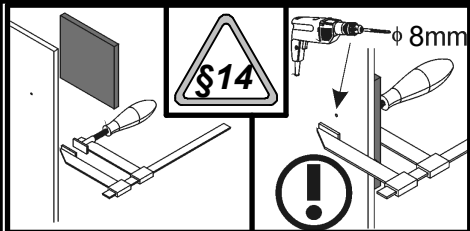

8

