

D1K0015

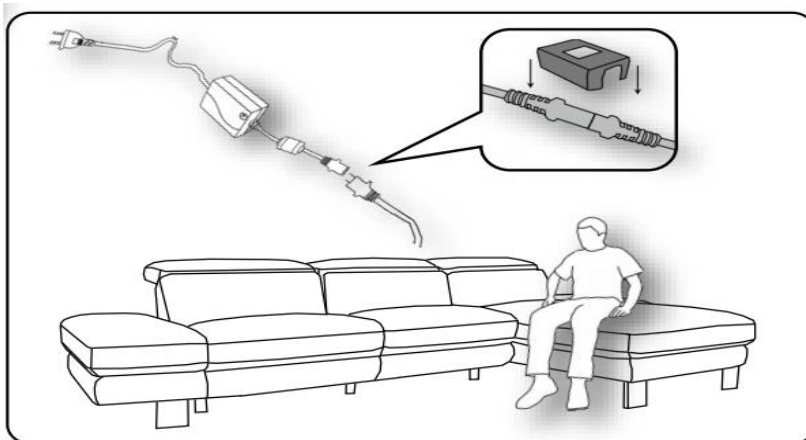

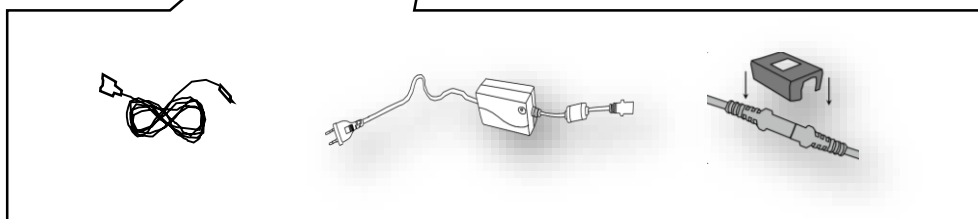

1

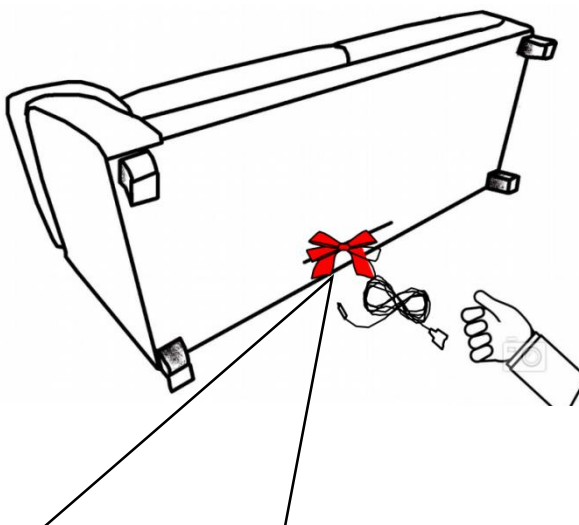
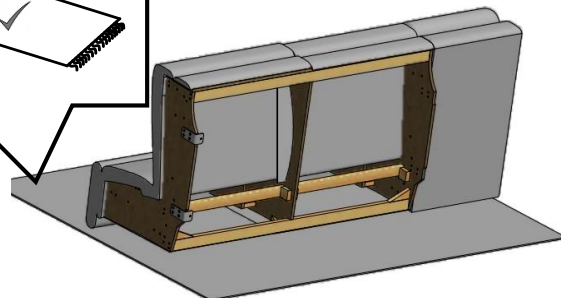
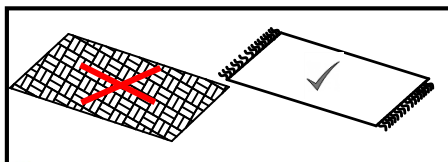
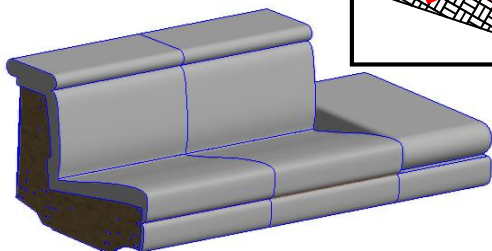
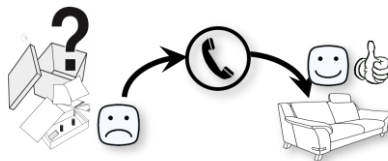
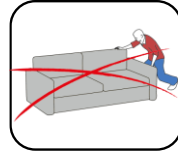
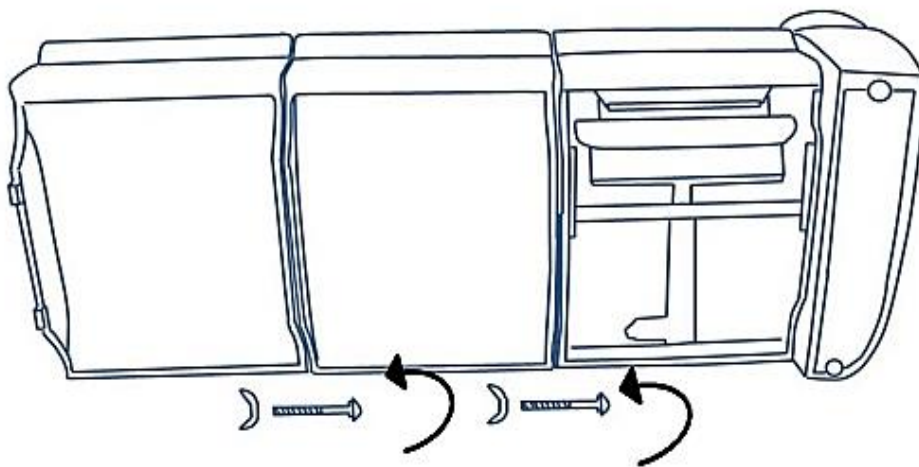

2

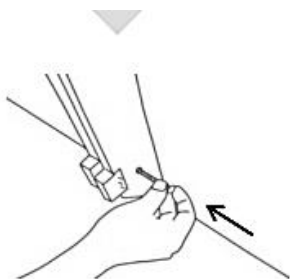

3

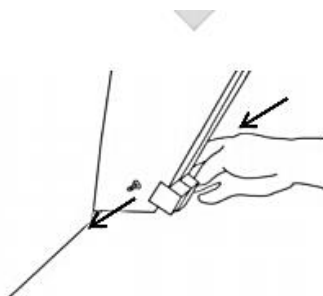

4

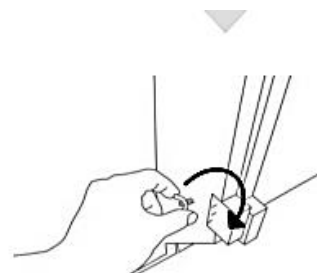

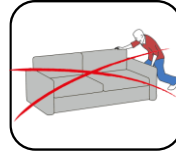

ACHTUNG!!!

Entfernen Sie die Transportsicherungen an den Funktionsbeschlägen.

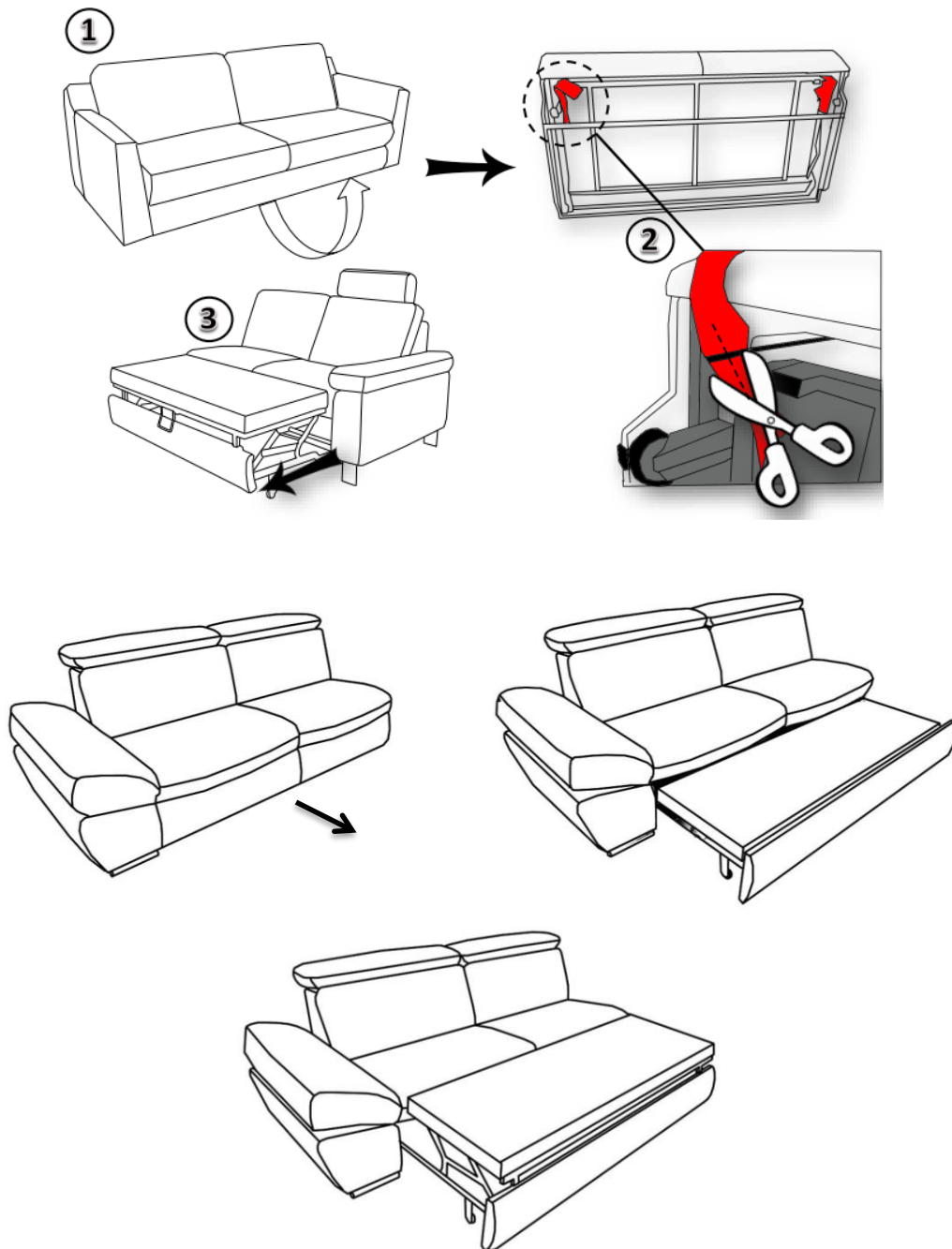

D1K0018

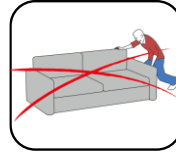

ACHTUNG!!!

Entfernen Sie die Transportsicherungen an den Funktionsbeschlägen.

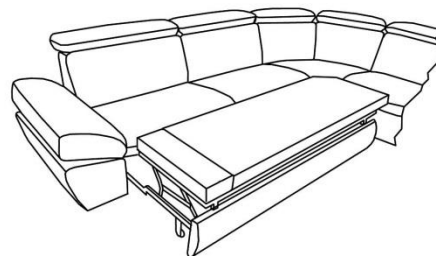
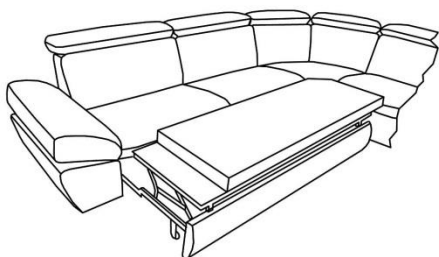
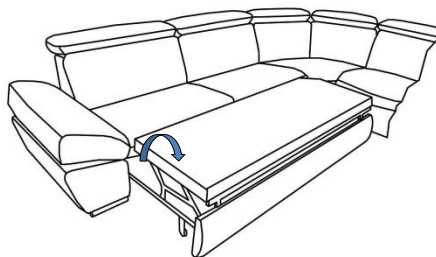
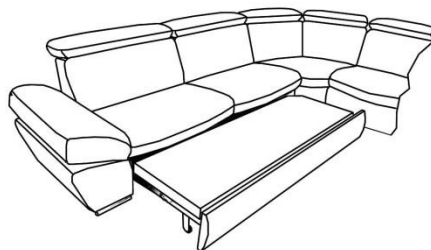
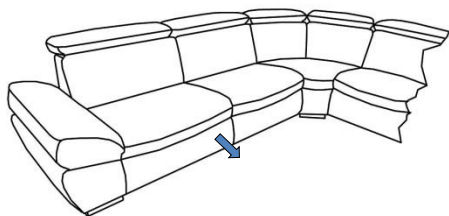
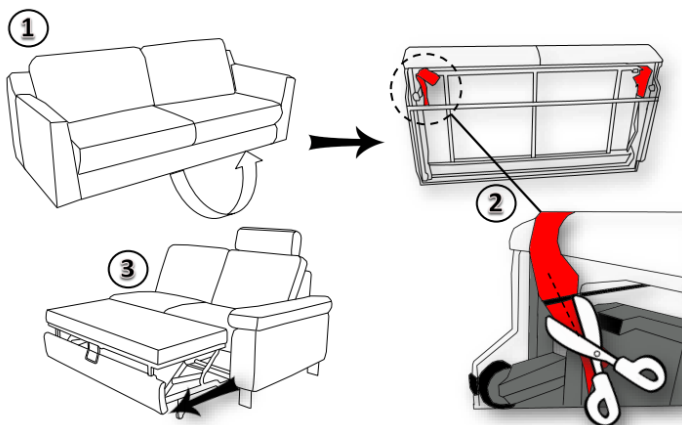

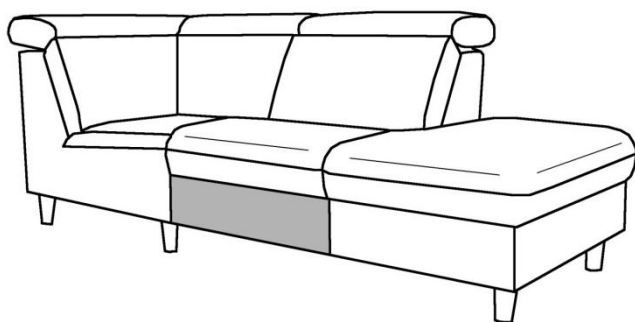
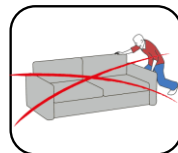

Max. 10kg

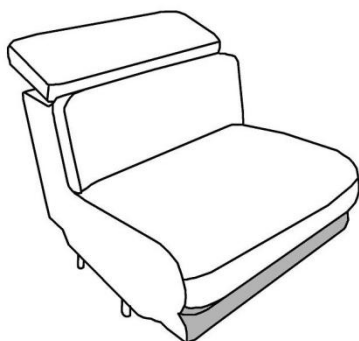
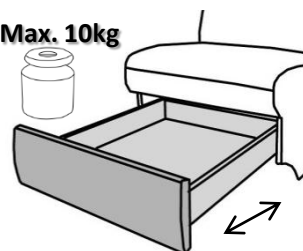

Max. 10kg

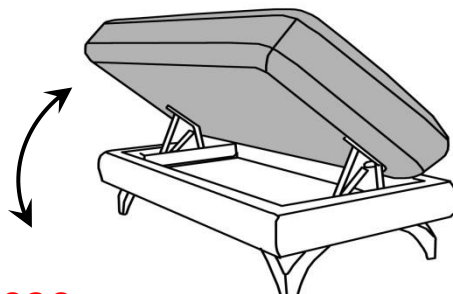
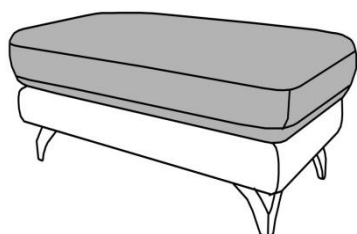
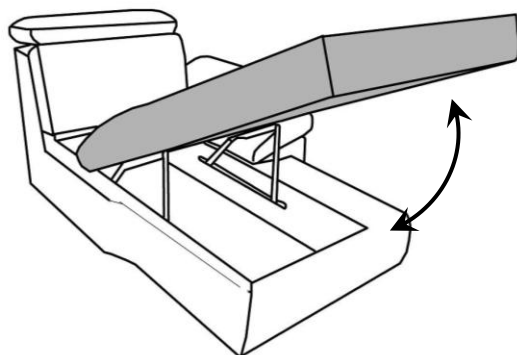
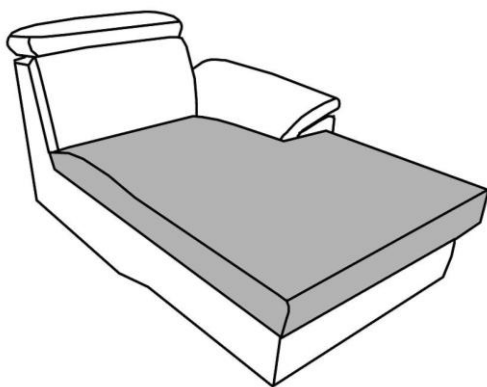
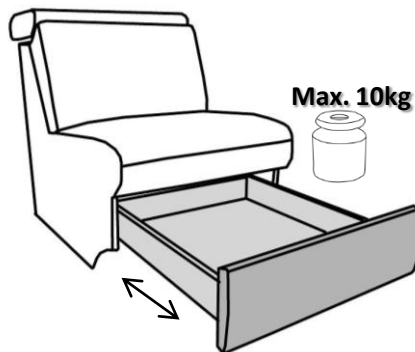

D1K0020

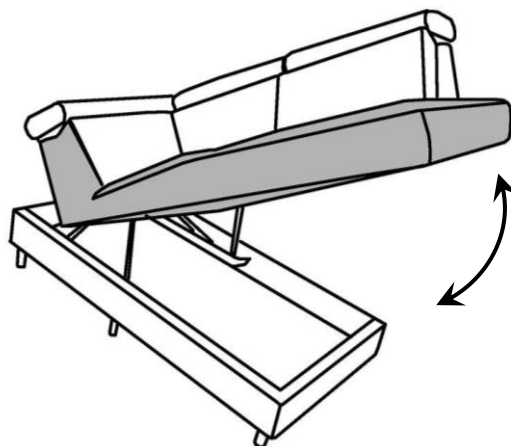
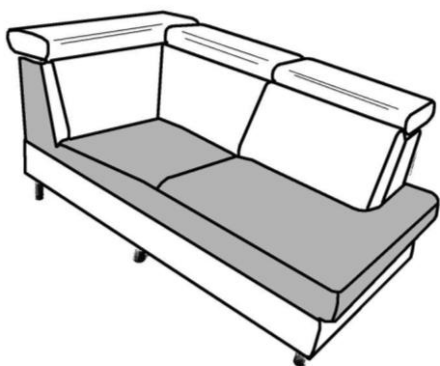
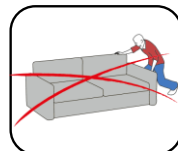

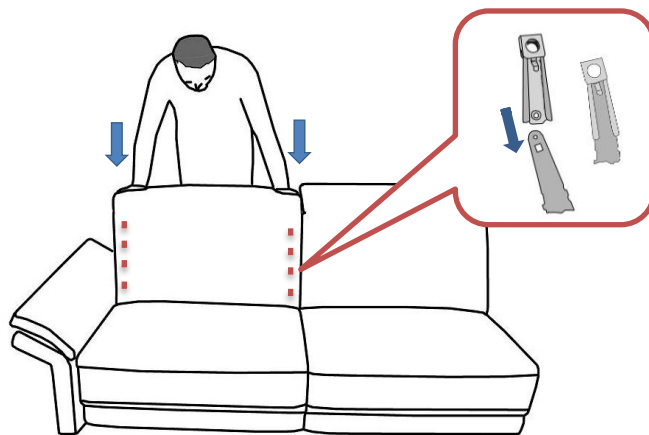
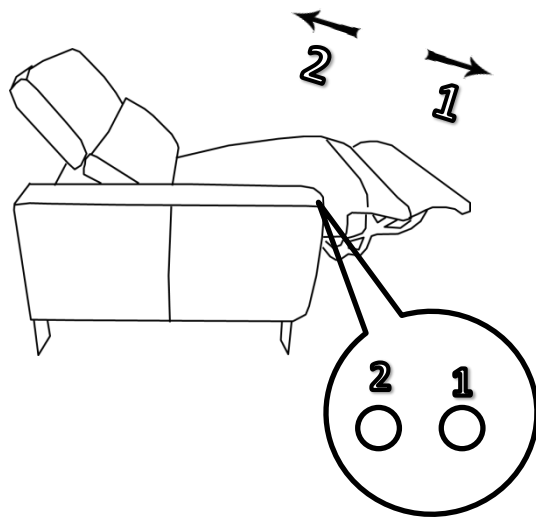
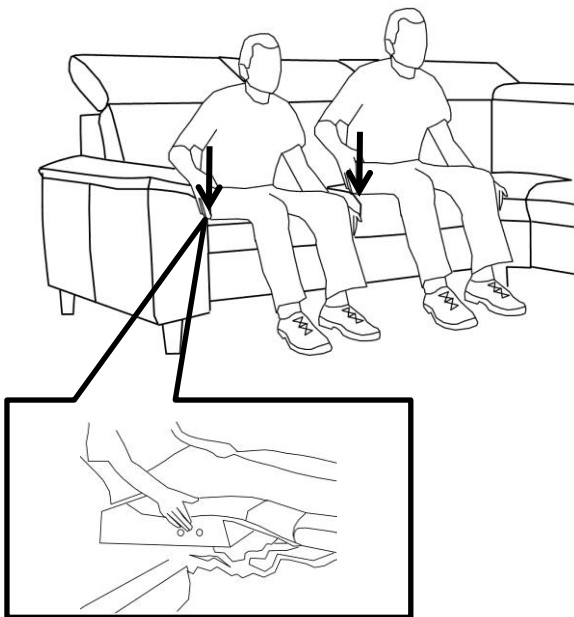
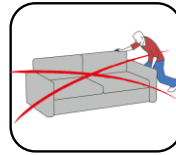

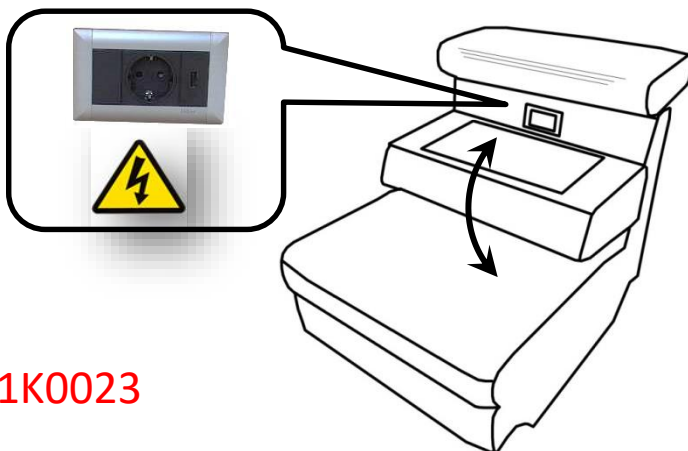
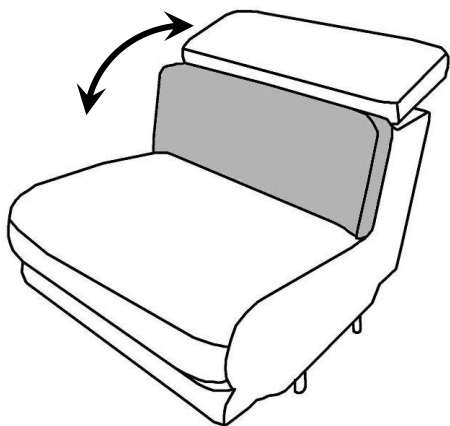
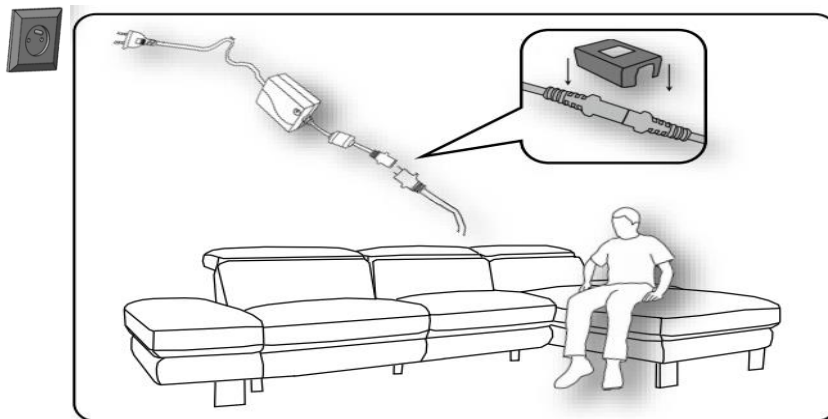
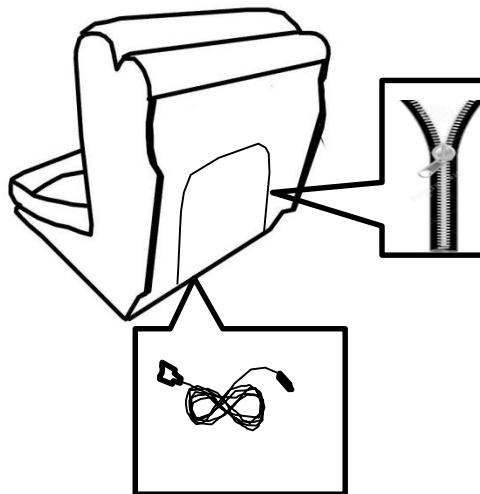
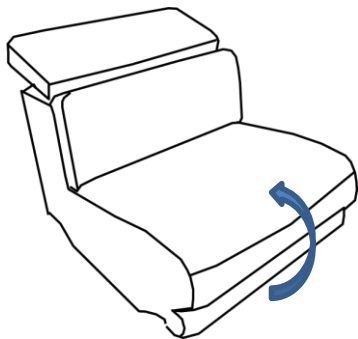
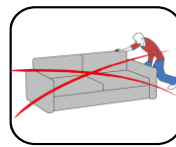

D1K0023

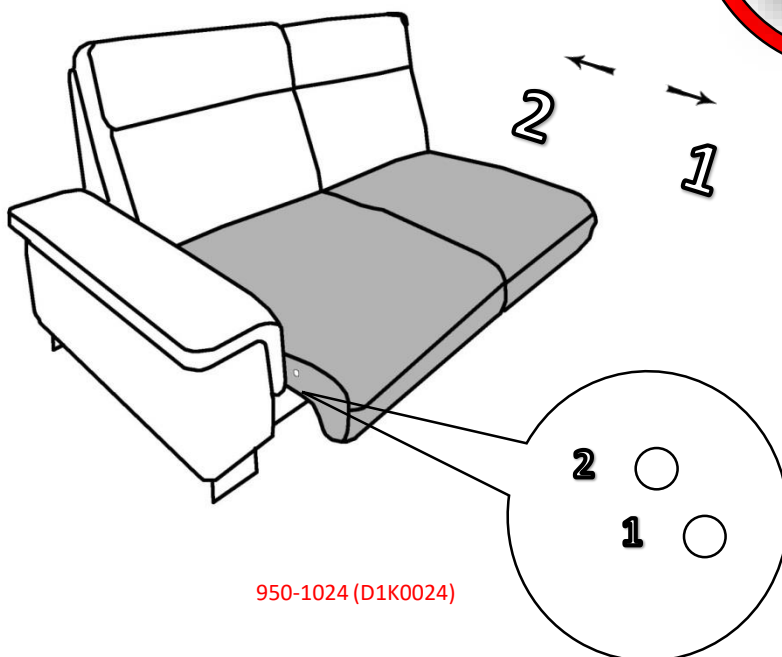
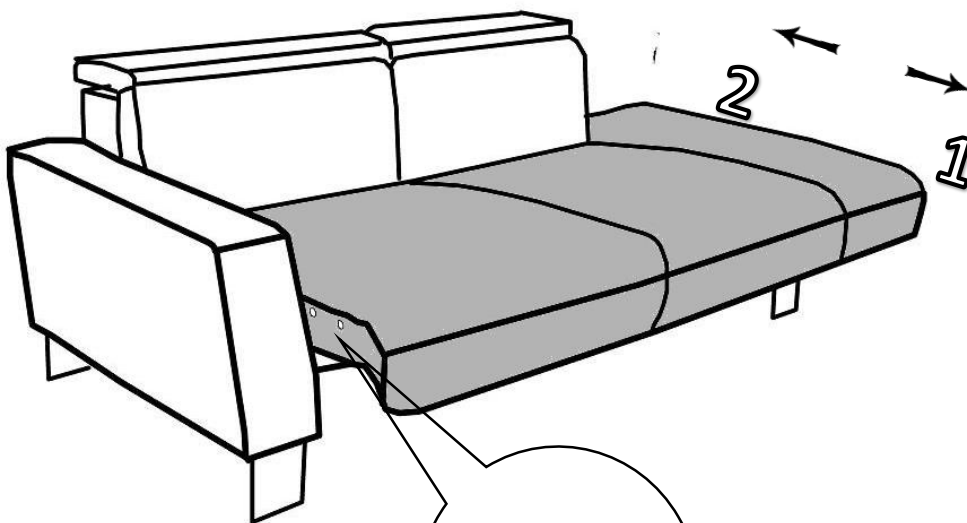
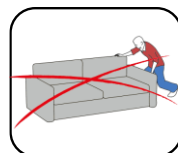

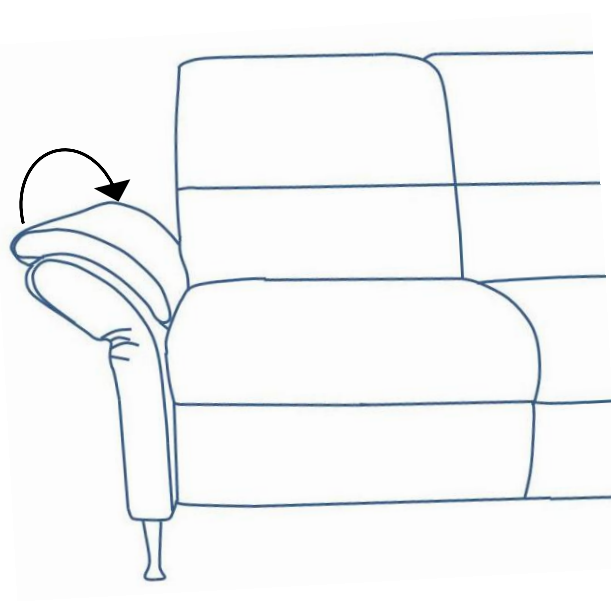
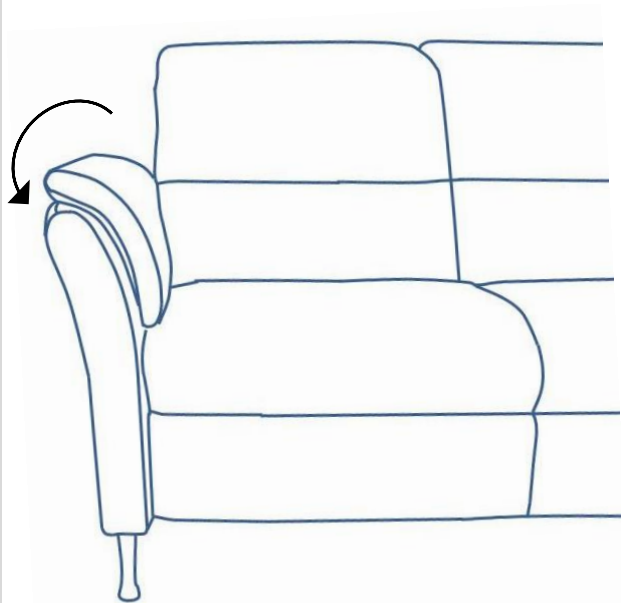
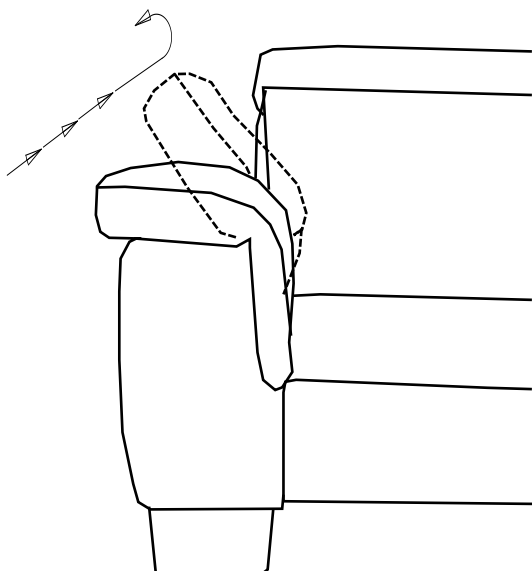
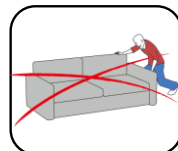

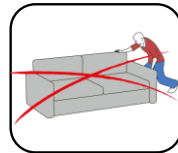

Höhenverstellbare Armlehne

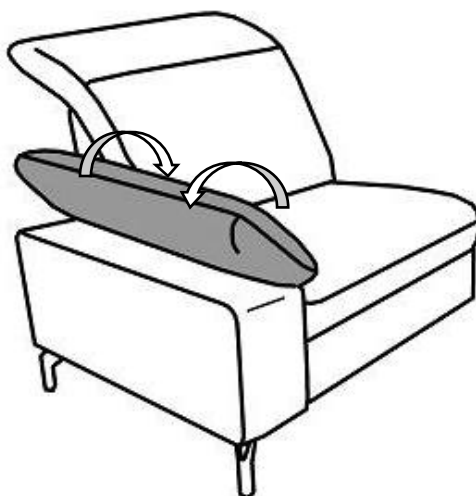
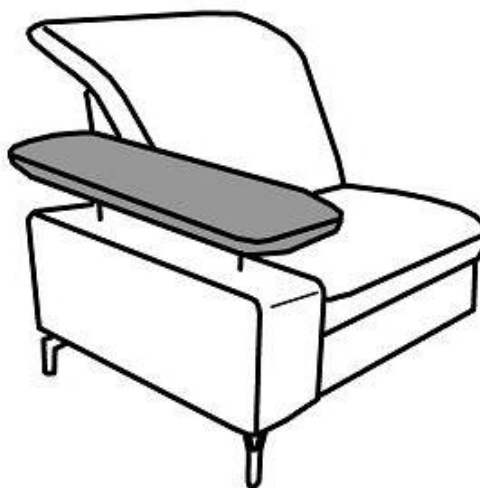
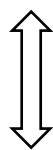
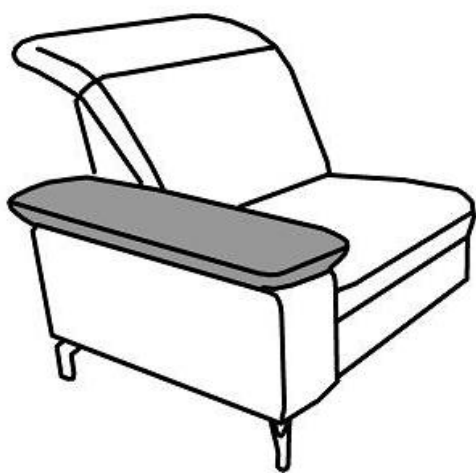

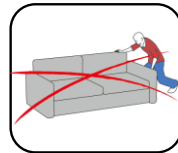

Manuell

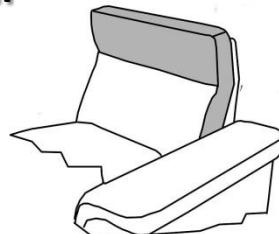

Motor

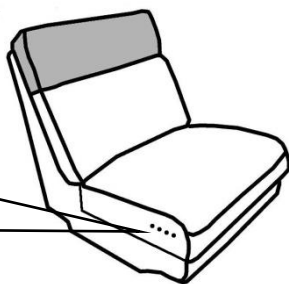
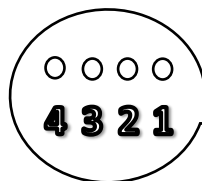

Manuell

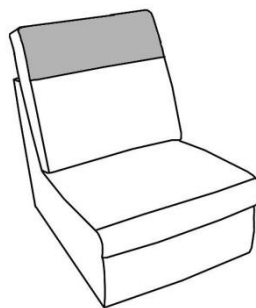
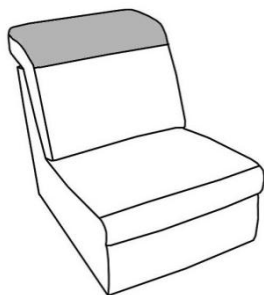

Motor

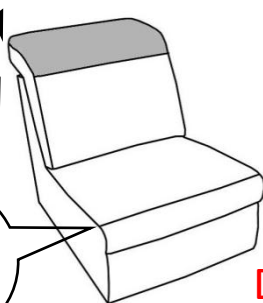
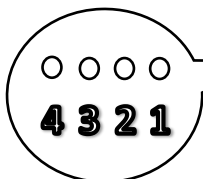

D1K0026

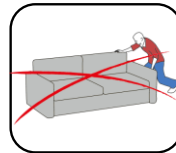

Manuell

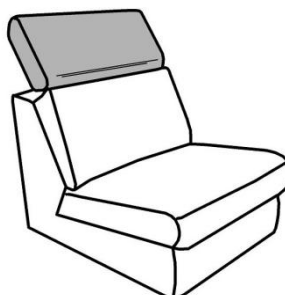
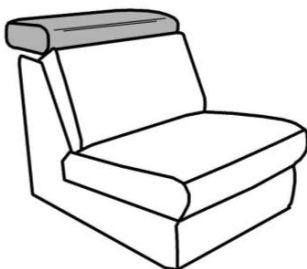

Motor

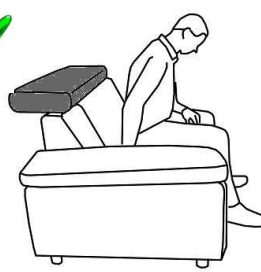
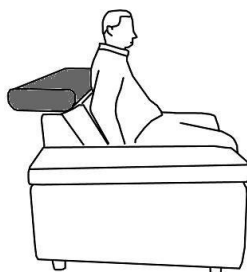
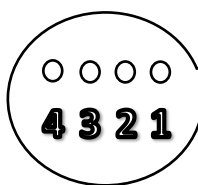
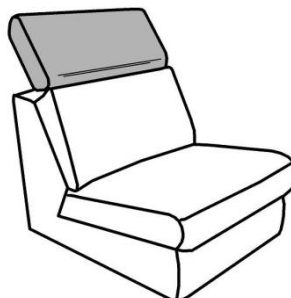
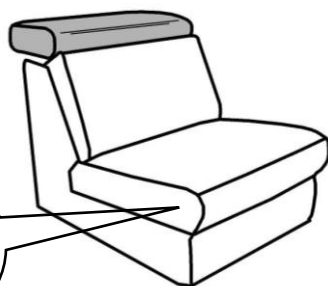

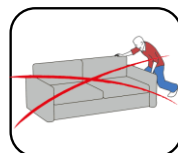

Manuell

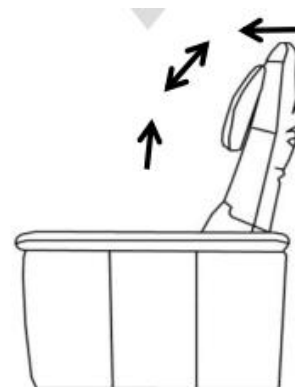
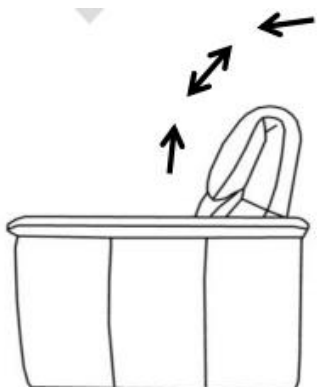

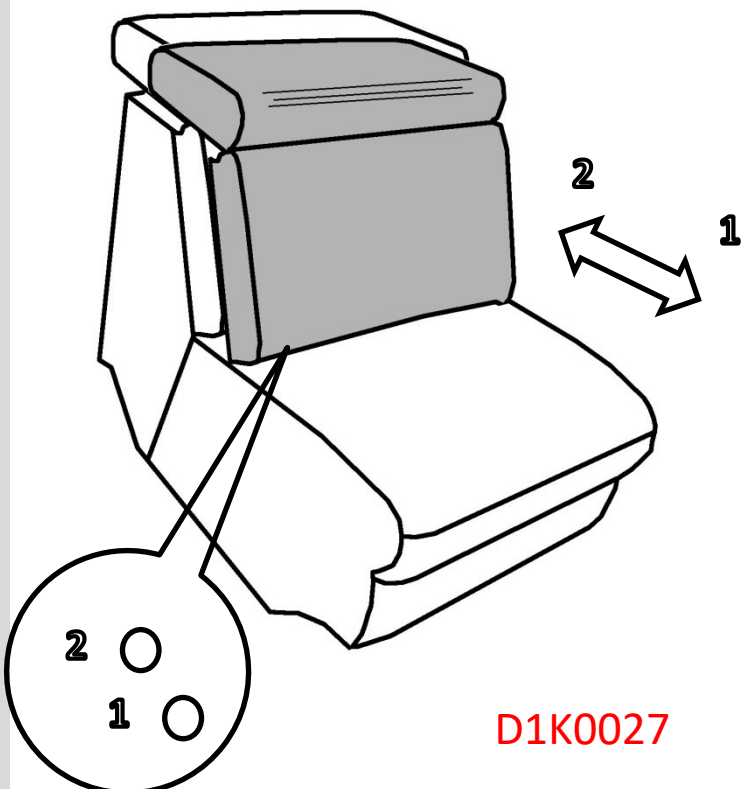
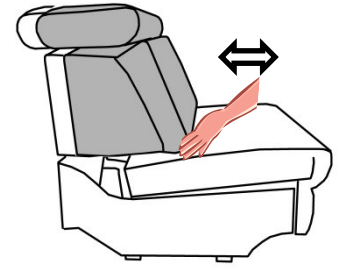
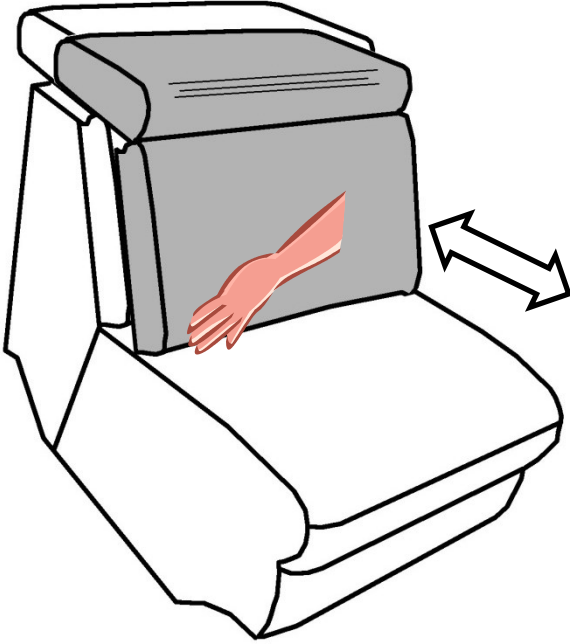
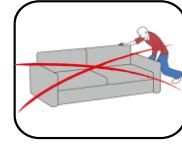

D1K0027

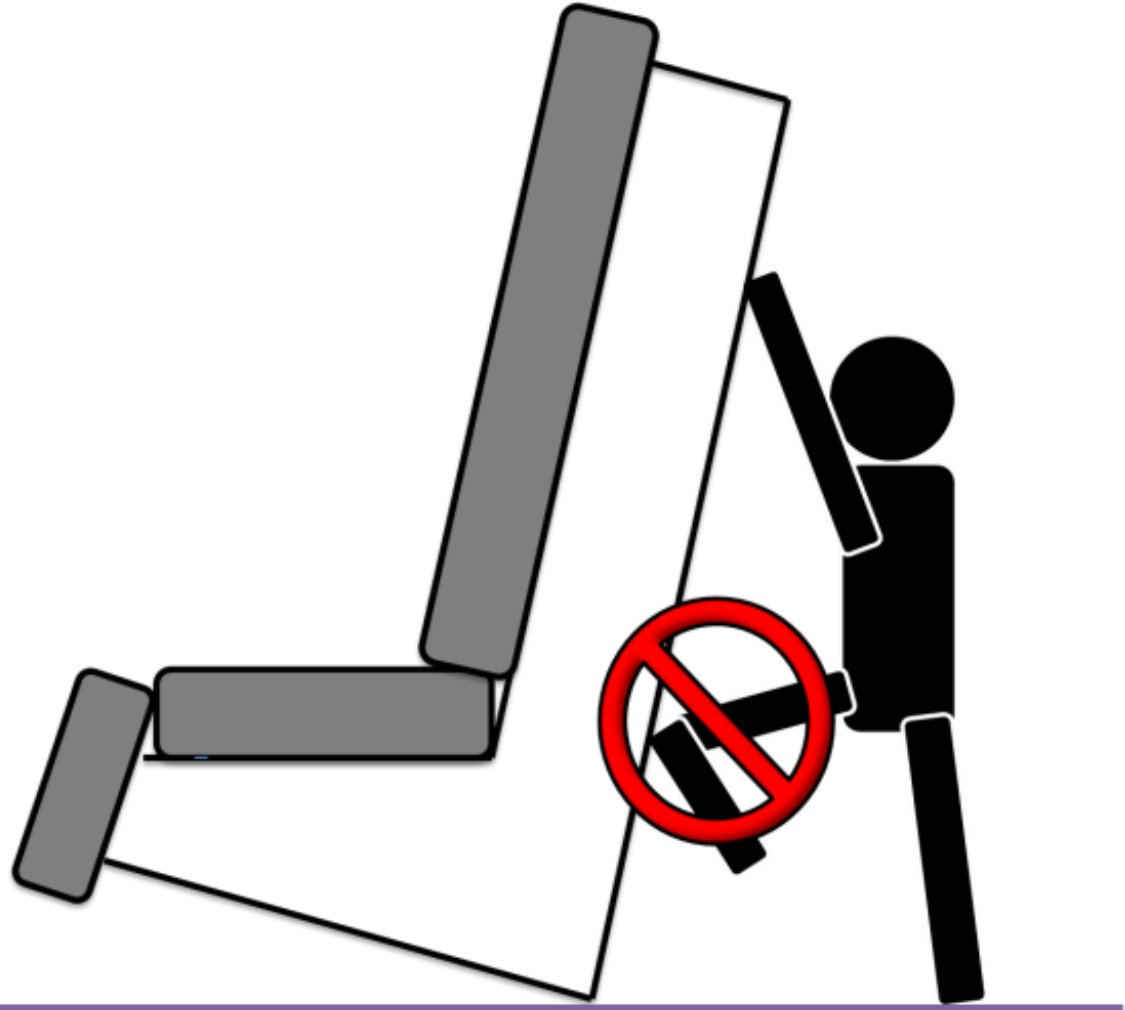
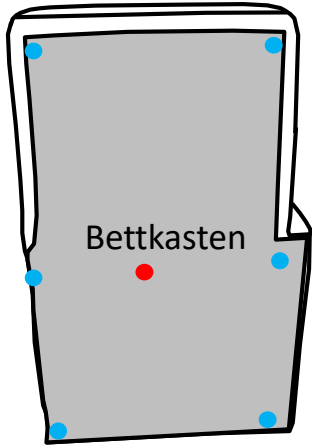
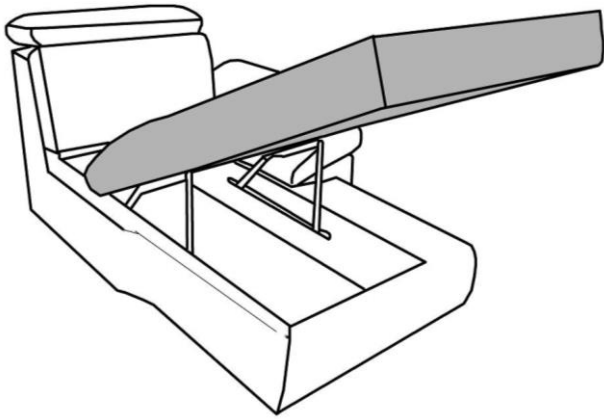

ACHTUNG !

ACHTUNG !!

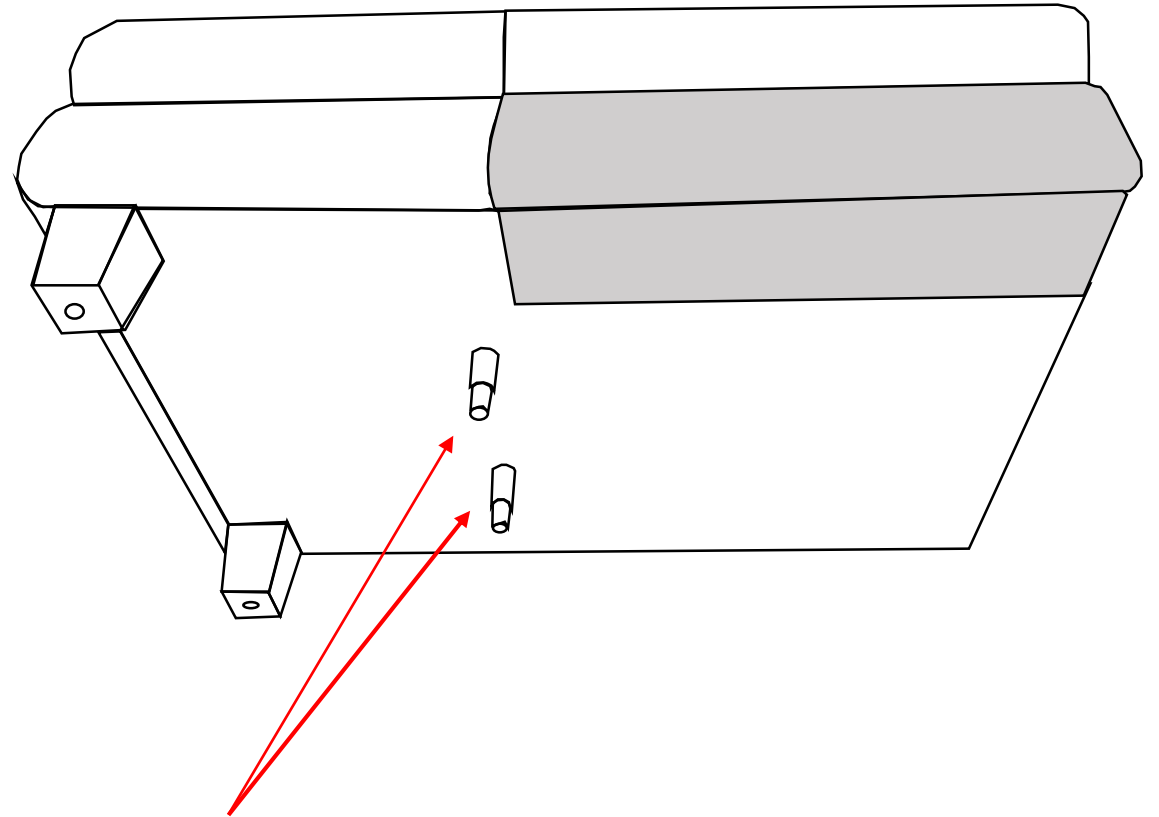
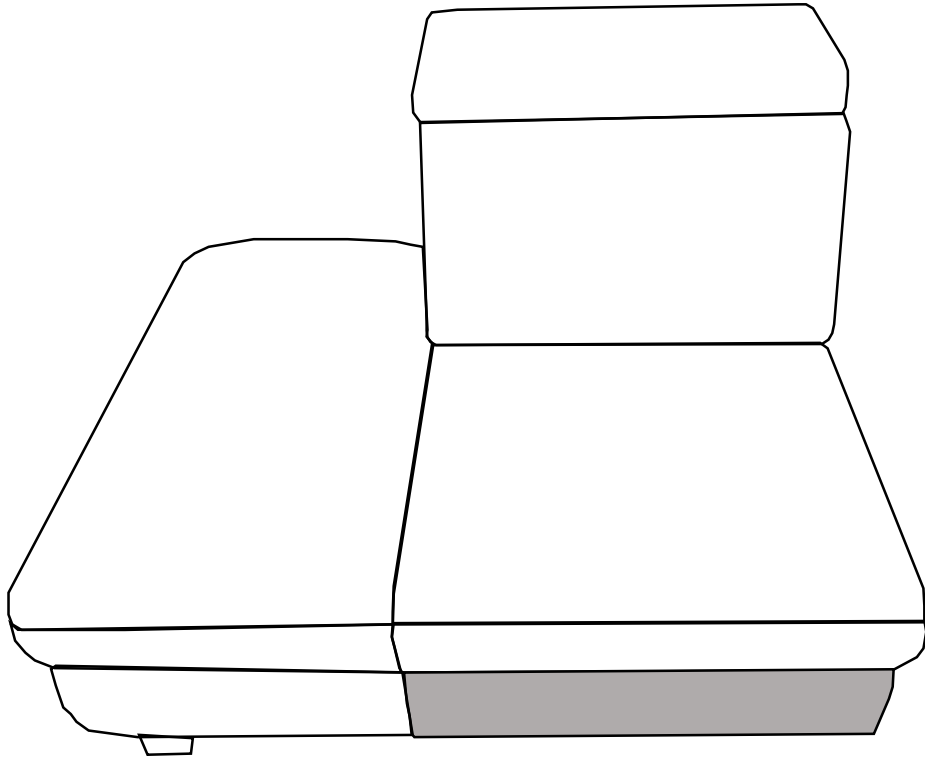

Hier Stützfüsse montieren und einstellen.

ACHTUNG !!

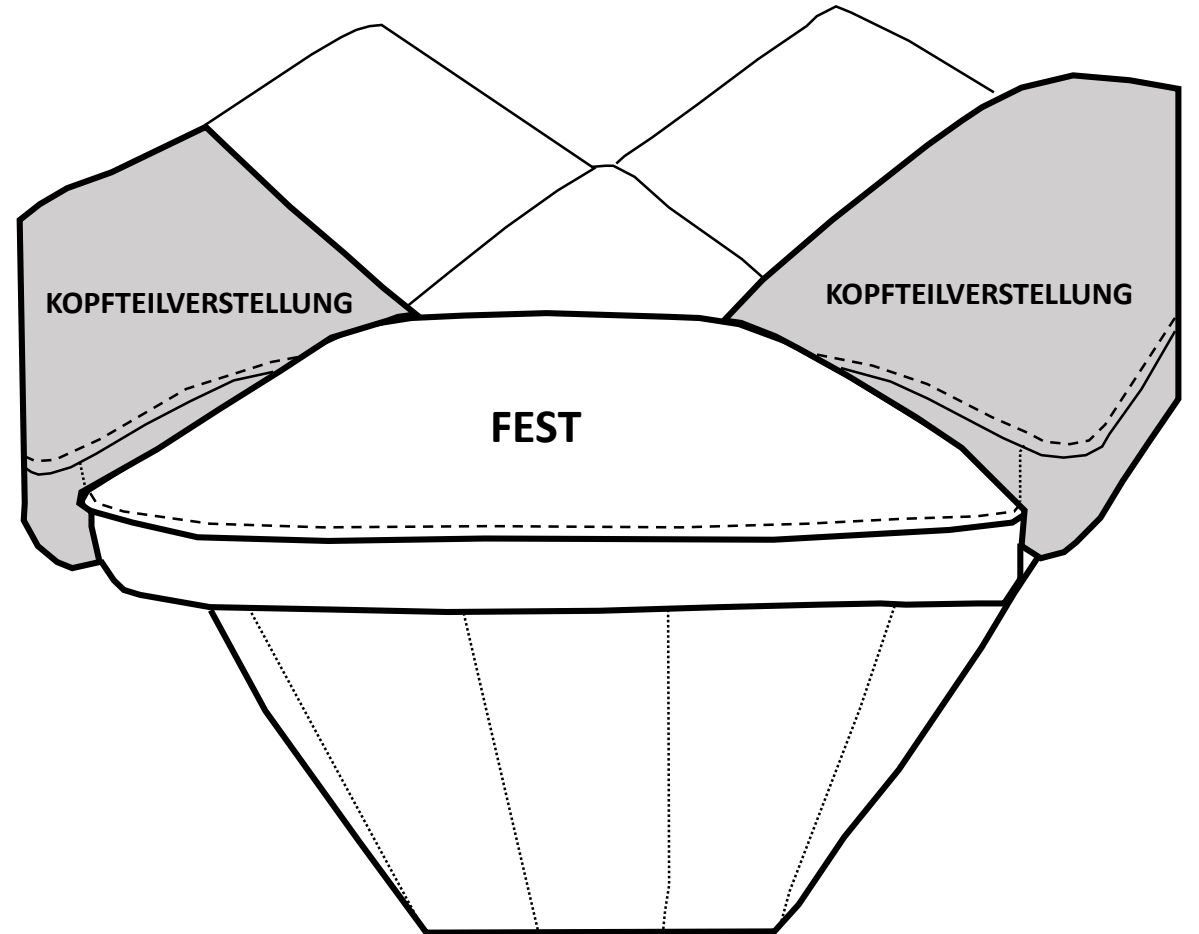
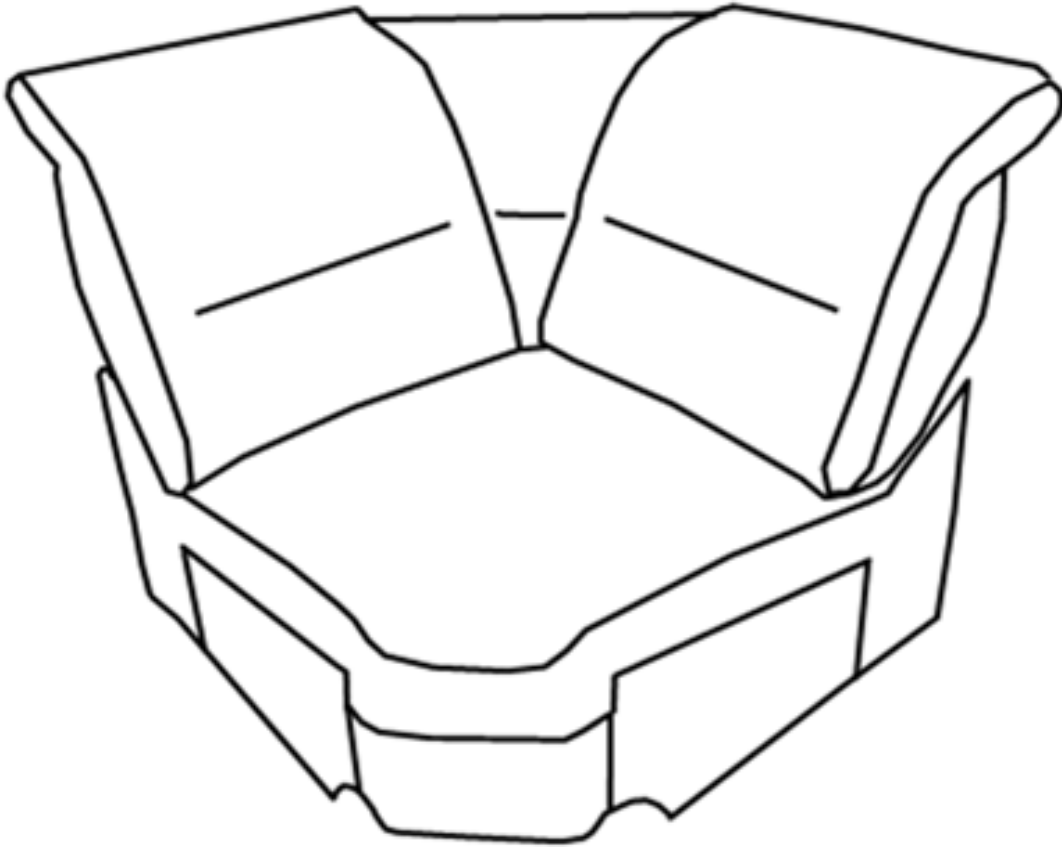

Massdifferenzen zwischen Kopfteilverstellung und Kopfteil fest sind warentypisch und kein Reklamationsgrund.

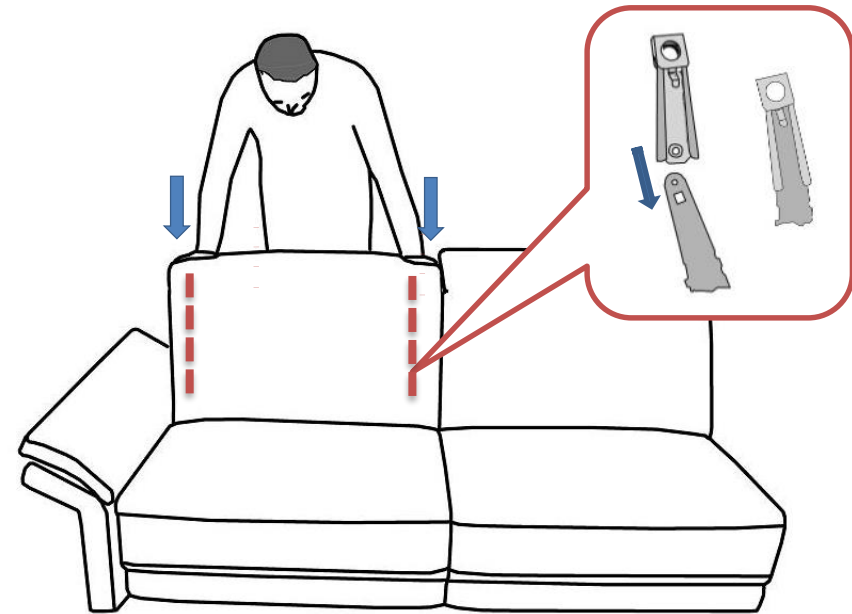
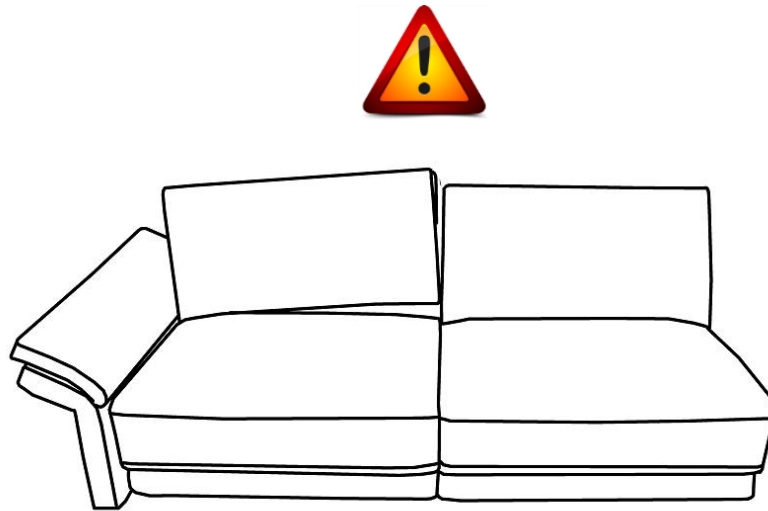

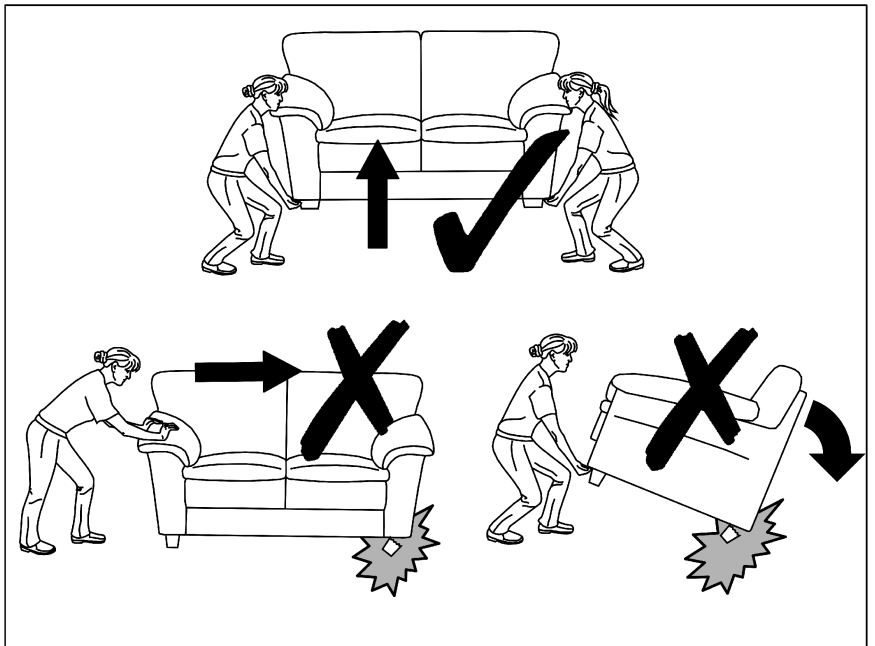
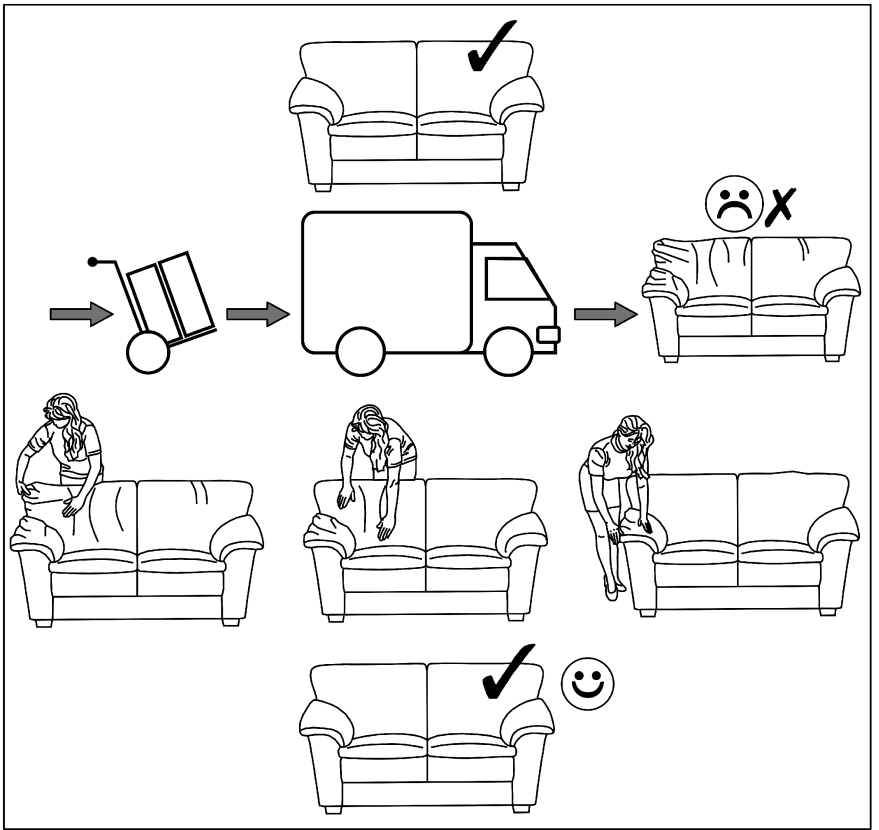
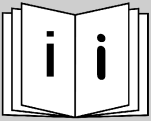

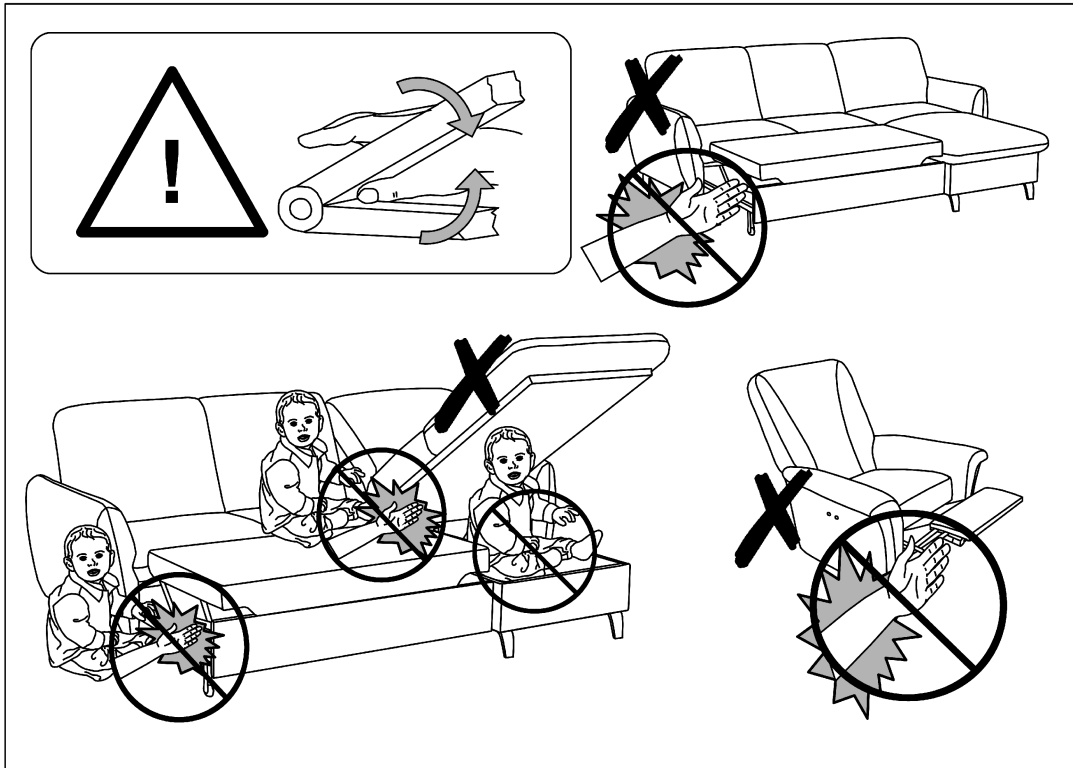
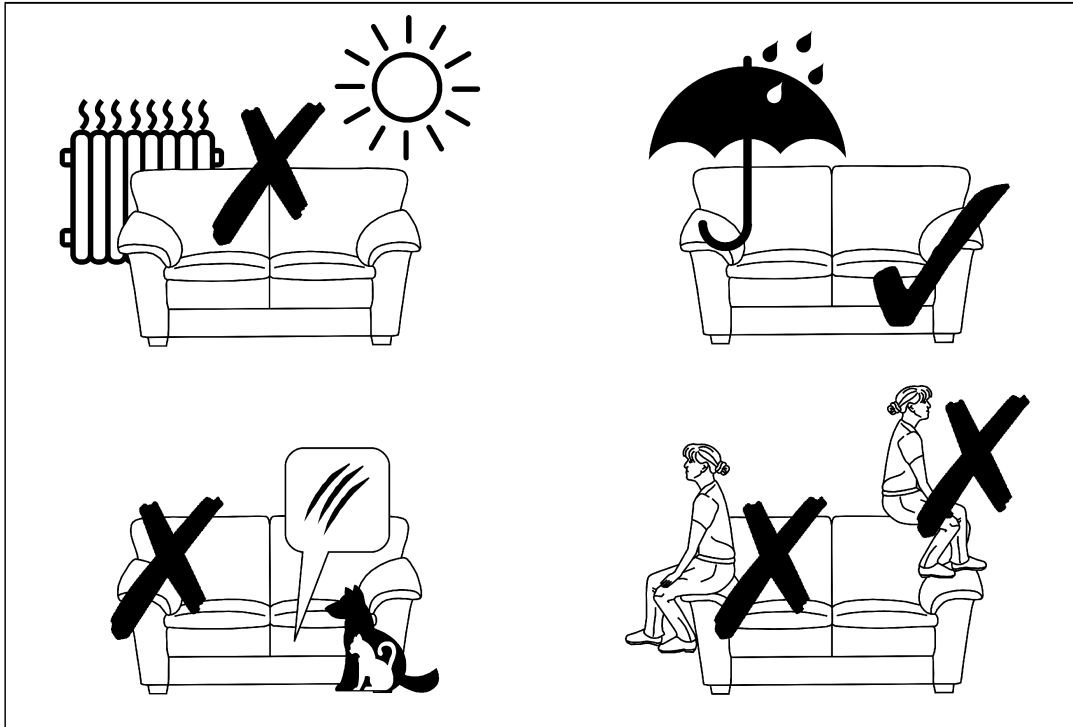

(DE) PFLEGEHINWEISE:

1. SORGFÄLTIG ENTSTAUBEN
2. MIT EINEM WEICHEN, SAUBEREN UND FEUCHTEM TUCH UND LEICHTER SEIFENLAUGE REINIGEN

	DEKOR PAPIER	OBERFLÄCHE LAMINAT	OBERFLÄCHE LACK	LACKIERTEN HOLZ	TEXTIL LEDER
SEIFENLAUGE (NEUTRAL SEIFE)	✓	✓	✓	✓	✓
WASSER MIT HAUSHALTREINIGER		✓	✓		
REINIGUNG NACH HERSTELLERVORGABE					✓

- BENUTZEN SIE KEINE SCHEUERMITTEL WIE PULVER, STAHLWOLLE, LÖSUNGSMITTEL
- NICHT ZU NASS ABWISCHEN

(GB) CONSERVATION ADVICES:

1. CAREFULLY WIPE OFF THE DUST
2. MOISTEN A SOFT, CLEAN CLOTH WITH SOAPY WATER

	VEENER WOOD	LAMINATE SURFACE	LAMINATED WOOD SURFACE	VARNISHED SURFACE	FABRIC LEATHER
WATER WITH SOAP (GREY SOAP)	✓	✓	✓	✓	✓
WATER WITH DETERGENT		✓	✓		
MAINTENANCE PRESCRIBED BY THE MANUFACTURER					✓

- DO NOT USE ABRASIVE PRODUCTS: POWDERS, STEEL WOOL, SOLVENTS
- DO NOT OVER-WET

(FR) CONSEILS D'ENTRETIEN:

1. DÉPOUSSIERER SOIGNEUSEMENT
2. HUMIDIFIER UN CHIFFON DOUX ET PROPRE D'EAU SAVONNEUSE

	BOIS DE PLACAGE	SURFACES STRATIFIÉES	SURFACES LAQUÉES	BOIS VERNIS	TISSU CUIR
EAU SAVONNEUSE (SAVON NEUTRE)	✓	✓	✓	✓	✓
EAU ADDITIONNÉE DE DÉTERGENT		✓	✓		
ENTRETIEN SPÉCIFIQUE FABRICANT					✓

- NE JAMAIS UTILISER DE PRODUITS ABRASIFS: POUDRE À RÉCURER, LAINE D'ACIER, SOLVANTS
- NE PAS TROP MOUILLER

(PL) PORADY W ZAKRESIE KONSERWACJI:

1. ZETRZEĆ DOKŁADNIE KURZ
2. CZYSTĄ I DELIKATNĄ ŚCIERECZKĘ ZWILŻYĆ LEKKO W WODZIE Z NIEWIELKĄ ILOŚCIĄ MYDŁA

	OKLEINA	POWIERZCHNIA LAMINATU	POW. DREWNA LAKOWANEGO	POWIERZCHNIA LAKIEROWANA	TKANINA SKÓRA
WODA Z MYDŁEM (SZARE MYDŁO)	✓	✓	✓	✓	✓
WODA Z DODATKIEM ŚRODKA MYJĄCEGO		✓	✓		
KONSERWACJA ŚCIŁIE WEDŁUG ZALECEN PRODUCENTA					✓

- NIGDY NIE UŻYWAĆ PRODUKTÓW ŚCIERNYCH: PROSZKÓW, DRAPAKÓW, ROZPUSZCZALNIKÓW
- NIE MOCZYĆ DUŻĄ ILOŚCIĄ WODY

(IT) CONSIGLI PER LA MANUTENZIONE:

1. SPOLVERATE ACCURATAMENLE
2. INUMIDIRE CON ACQUA LEGGERMENTE INSAPONATA UNO STRACCIO MORBIDO PULITO

	CARTA	SUPERFICIE STRATIFICATA	SUPERFICIE LACCATE	LACCATE E LEGNO VERNICIATO	TESSILE PELLE
ACQUA CON SAPONE (SAPONE NEUTRO)	✓	✓	✓	✓	✓
ACQUA CON DETERSIVO SAN MARO		✓	✓		
MANUTENZIONE SPECIFICA PRODUTTORE					✓

- NON UTILIZZARE MAI PRODOTTI ABRASIVI: POLVERE, LANA DI ACCIAIO, SOLVENTI
- NON BAGNARE TROPPO

(ES) CONSEJOS PARA EL MANTENIMIENTO:

1. LIMPIAR EL POLVO CON CUIDADO
2. HUMEDECER UN PAÑO SUAVE Y LIMPIO CON AGUA LIGERAMENTE ENJABONADA

	CHAPA DE MADERA	SUPERFICIE LAMINADA	MADERA BARNIZADA	SUPERFICIE LACADA	TELA PIEL
AGUA Y JABON (JABON NEUTRO)	✓	✓	✓	✓	✓
AGUA CON DETERGENTE		✓	✓		
MANTENIMIENTO ESPECIFICO DEL FABRICANTE					✓

- NO USE NUNCA PRODUCTOS ABRASIVOS TALES COMO POLVO DE LIMPIAR, RASCADOR, DISOLVENTES
- NO MOJAR EXAGERADAMENTE

(PT) CONSELHOS PARA A MANUTENÇÃO:

1. LIMPE O POEIRO COM CUIDADO
2. UMEDECER UM PAÑO SUAVE E LIMPO COM AGUA E UM POUCO DE SABAO

	PLACA DE MADEIRA	SUPERFÍCIE LAMINADA	MADEIRA ENVERNIZADA	SUPERFÍCIE LACADA	TELA PELE
AGUA COM SABÃO (SABÃO NEUTRO)	✓	✓	✓	✓	✓
AGUA COM ST MARC		✓	✓		
INSTRUÇÕES ESPECIFICAS					✓

- NUNCA UTILIZAR PRODUTOS ABRASIVOS POS, LA DE AÇO, SOLVENTES
- NAO MOLHAR DEMASIADO

(SK) TYPY NA ÚDRŽBU:

1. PRACH DOKŁADNE UTRITE
2. ČISTU A JEMNU HANDRIČKU NAVLHČIŤ LAHKO VO VODE Z MALÝM MNOŽSTVOM MYDLA

	TENKÁ LAMINÁTOVÁ	LAMINÁTOVÝ POVRCH	DREVENÝ POVRCH LAKOVANÝ	LAKOVANÝ POVRCH	TKANINA ČALÚDNEŤ
VODA Z MYDLOM	✓	✓	✓	✓	✓
VODA Z UMYVAJÚCIM PROSTRIEDKOM		✓	✓		
ÚDRŽBA IBA PODĽA POPISU VÝROBCU					✓

- NIKDY NEPOUŽÍVAŤ PROSTRIEDKY S DRSNÝM POVRCHOM : PRAŠKOV, DROBENIEK A RIEDIDIEL• NENAMÁČAJTE VEĽKÝM MNOŽSTVOM VODY

(CZ) TYPY NA UDRŽBU:

1. DŮKLADNĚ OTRIT PRACH
2. ČISTÝ A MĚKKÝ HADRÍK LEHCE NAVLHČIT VE VODĚ S MALÝM MNOŽSTVÍM MÝDLA

	DÝHA	LAMINÁTOVÝ POVRCH	LAKOVANÝ DŘEVĚNÝ POVRCH	LAKOVANÝ POVRCH	KOŽENÁ ČALOUNĚNÁ LÁTKA
VODA S MÝDLEM	✓	✓	✓	✓	✓
VODA S ČISTIČÍM PROSTŘEDKEM		✓	✓		
DODRŽET ÚDRŽBU POSKYTOVANOU VÝROBCEM					✓
• NEPOUŽÍVEJTE ABRÁZIVNÍ PROSTŘEDKY: PRASEK, ROZPOUSTĚDLA					
• NENAMACĚJTE VELKÉ MNOŽSTVÍ VODY					

(NL) ONDERHOUDSVOORSCHRIFT:

1. ZORGVULDIG STOFVRIJ MAKEN
2. MET EEN ZACHTE SCHONE EN VOCHTIGE DOEK MET NEUTRALE ZEEP REINIGEN

	FOLIE	TOPLAAG LAMINAAT	TOPLAAG LAK	GELAKT HOUT	TEXTIEL LEER
NEUTRALE ZEEP	✓	✓	✓	✓	✓
WATER MET HUISHOUD REINIGINGSMIDDEL		✓	✓		
DOOR DE PRODUCENT GESPECIFICEERD ONDERHOUD					✓
• GEBRUIKT U GEËN SCHUURMIDDELEN ZOALS SCHUURPOEDER, STAALWOL, OPLOSMIDDEL					
• NIET TE NAT AFNEMEN					

(HU) KARBANTARTÁSI TANÁCSOK:

1. ALAPOSAN LETÖRÖLNI A PORT
2. EGY TISZTA ÉS LÁGY TÖRLŐKENDŐT BENEDVESÍTENI ENYHÉN SZAPPANOS VÍZZEL

	FURNÉR	LAMINÁLT FELÜLET	LAKKOZOTT FAFELÜLET	LAKKOZOTT FELÜLET	BŐRKÁRPIT
SZAPPANOS VÍZ (MOSÓSZAPPAN)	✓	✓	✓	✓	✓
MOSÓSZERES VÍZ		✓	✓		
KARBANTARTÁS SZIGORÚAN A GYÁRTÓ UTASÍTÁSAI SZERINT					✓
• SOHA NE HASZNÁLJON SÚROLO HATASU TISZTÍTÓSZERT: PORT, KAPAROT, OLDOSZERT					
• NE ZATASSA BO VÍZZEL					

(RO) SFATURI PENTRU ÎNTREȚINERE:

1. ȘTERGEȚI BINE PRAFUL
2. UMEZIȚI UȘOR O LAVETĂ USCATĂ ȘI DELICATĂ ÎN APĂ CU PUȚIN SĂPUN

	FURNIR	SUPRAFAȚĂ LAMINAT	SUPRAFAȚĂ LEMN LĂCUIȚ	SUPRAFAȚĂ LĂCUIȚĂ	ȚESĂTURĂ CĂPTUȘEALĂ PIELE
APĂ CU SĂPUN	✓	✓	✓	✓	✓
APĂ CU DETERGENT		✓	✓		
ÎNȚREȚINEȚI ÎN CONFORMITATE STRICTĂ CU RECOMANDĂRILE PRODUCĂTORULUI					✓
• NU FOLOSIȚI NICIODATĂ PRODUSE ABRABIVE: DETERGENȚI PRF, ZGĂRIETOARE, DILUANȚI					
• NU SPĂLAȚI CU O CANTITATE MARE DE APĂ					

(RU) РЕКОМЕНДАЦИИ ПО УХОДУ:

1. ТЩАТЕЛЬНО ВЫТЕРЕТЬ ПЫЛЬ
2. ЧИСТУЮ И МЯГКУЮ ТРЯПОЧКУ СЛЕГКА УВЛАЖНИТЬ В ВОДЕ С НЕБОЛЬШИМ КОЛИЧЕСТВОМ МЫЛА

	ОБЛИЦОВКА	ЛАМИНИРУЮЩА Я ПЛЁНКА	ПОВЕРХНОСТЬ ЛАКИРОВАННОЙ ДРЕВЕСИНЫ	ЛАКИРОВАННАЯ ПОВЕРХНОСТЬ	ОБИЧОВНАЯ ТКАНЬ, КОЖА
ВОДА С МЫЛОМ (ХОЗЯЙСТВЕННОЕ МЫЛО)	✓	✓	✓	✓	✓
ВОДА С ДОБАВКОЙ МОУЩЕГО СРЕДСТВА		✓	✓		
УХОД СТРОГО ПО УКАЗАНИЯМ ПРОИЗВОДИТЕЛЯ					✓
• НИ В КОЕМ СЛУЧАЕ НЕ ИСПОЛЬЗОВАТЬ АБРАЗИВНЫХ ИЗДЕЛИЙ: ПОРОШКОВ, ЦАРАПОК, РАСТВОРИТЕЛЕЙ					
• НЕ СМАЧИВАТЬ БОЛЬШИМ КОЛИЧЕСТВОМ ВОДЫ					

(TU) BAKIM TALÍMATLARI:

1. TOZUNU DIKKATLICE ALINIZ
2. YUMUŞAK VE TEMİZ BİR BEZİ SABUNLU SU İLE ISLATINIZ

	KAPLAMA	LAMİNAT YÜZEY	LAKE AHŞAP YÜZEY	LAKE YÜZEY	DÖŞEMELİK KUMAŞ, DERİ
SABUNLU SU (NORMAL SABUN)	✓	✓	✓	✓	✓
DETERJANLI SU		✓	✓		
ÜRETİCİNİN BAKIM VE YIKAMA TALÍMATLARI					✓
• TOZ, TEL, SOLVENT GIBI AŞINDIRICI URUNLERİ KULLANMAYINIZ					
• BOL SU İLE ISLATMAYINIZ					

(SI) NASVETI ZA VZDRŽEVANJE:

1. SKRBNO OBRISITE PRAH
2. ČISTO IN MEHKO KRPO RAHLO NAVLAŽITE V VODI Z MAJHNO KOLIČINO MILA

	FURNIR	POVRŠINA LAMINATA	POVRŠINA LES LAK	LAKIRANA POVRŠINA	OBLAZINJENJE USNJE
VODA IN MILO (MEHKO MILO)	✓	✓	✓	✓	✓
VODA Z DODATKOM DETERGENTA		✓	✓		
VZDRŽEVATI DOSLEDNO V SKLADU Z NAVODILI PROIZVAJALCA					✓
• NIKOLI NE UPORABUJATE ABRÁZIVNIH SREDSTEV: PRAŠKOV, GOBIC IZ ŽICE, TOPIL					
• NE NAMAKAJTE Z VELIKO KOLIČINO VODE					

(HR) UPUTE ZA ODRŽAVANJE:

1. PAŽLJIVO OBRISATI PRAŠINU
2. PREBRISATI ČISTOM, MEKOM TKANINOM NAVLAŽENOJ U BLAGOJ OTOPINI SAPUNA ILI DETERDŽENTA

	PAPIR	LAMINAT	LAK	DRVO	TEKSTIL KOŽA
OTPINA SAPUNA	✓	✓	✓	✓	✓
OTPINA DETERDŽENTA		✓	✓		
NAMIJENSKA SREDSTVA					✓
• ZABRANJENA JE UPOTREBA KEMIKAJIJA ILI BILO KAKVIH POMOĆNIH SREDSTAVA ZA RIBANJE JAKIH DSREDSTAVA ZA ČIŠĆENJE ILI ČELIČNE VUNE					
• ZABRANJENO JE ČIŠĆENJE SA PREVIŠE VODE/VLAGE					

SCS Sp. z o.o.

Ul. Fabryczna 13

69-110 Rzepin

Polen

polsteria@steinpol.com.pl