

A	B1	B2	C1	C2	C3	D
1	S592-1018	-7	388	400	12	1/1
2	S592-1019	-6	488	396	12	1/1
3	S592-1020	-3	488	114	16	1/1
4	S592-2012	-6	1150	600	12	1/1
5	S592-2013	-6	700	400	12	1/1
6	S592-3020	-6	572	396	12	1/1
7	S592-4006	-5	572	90	12	1/1
8	S592-4008	-6	672	82	12	1/1
9	S592-4009	-6	572	190	12	1/1
10	S592-4012	-6	357	188	12	1/1

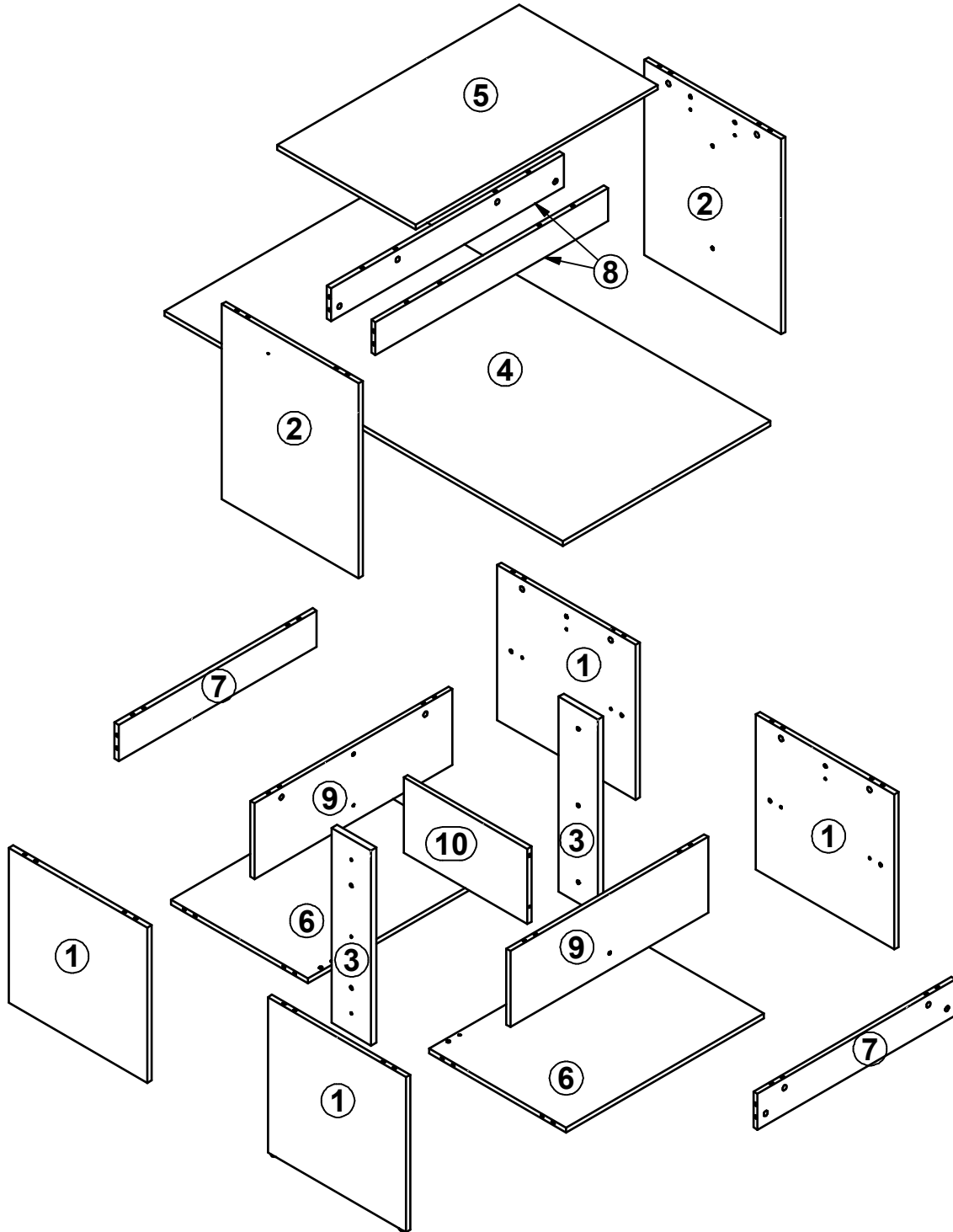

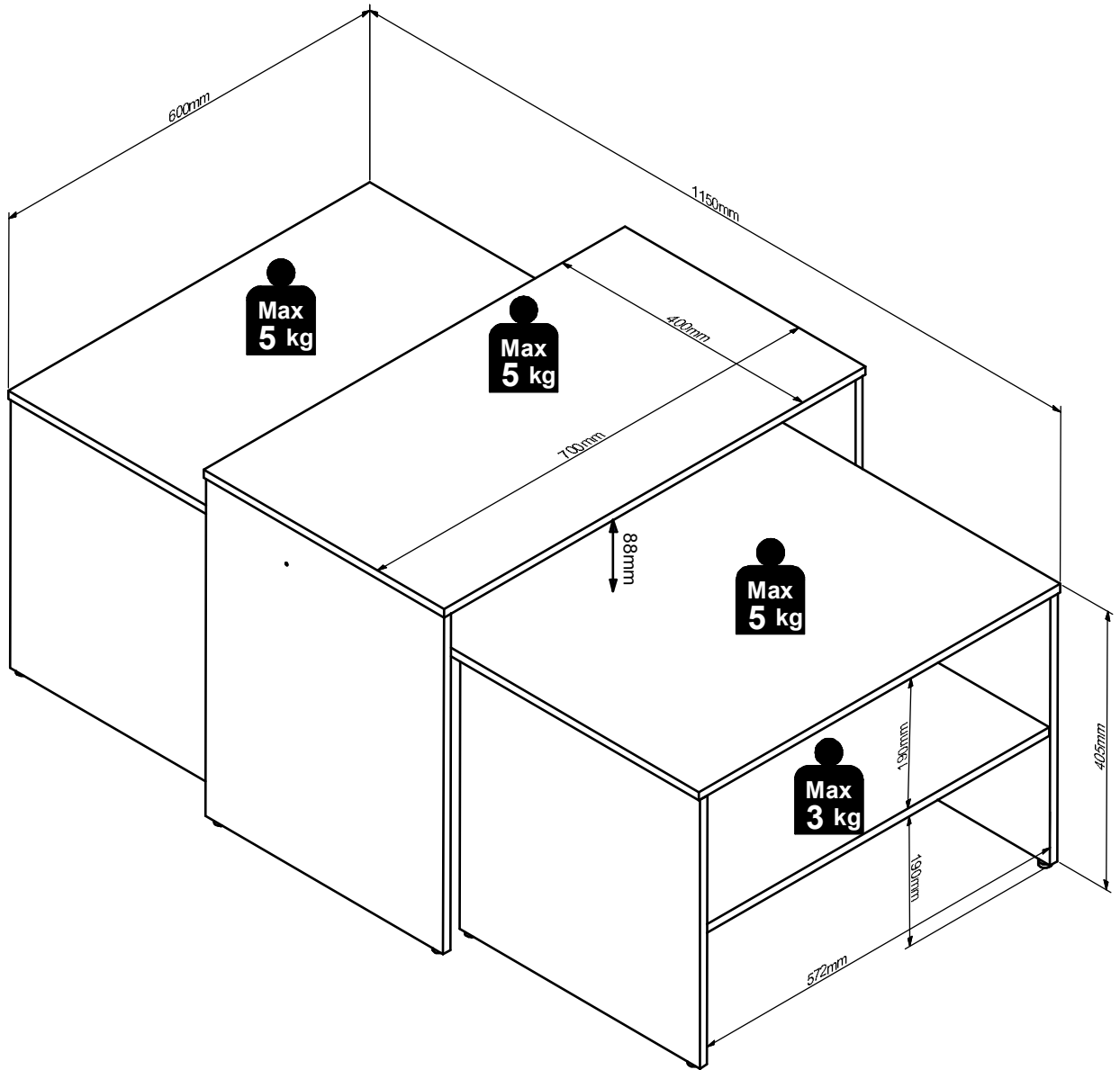

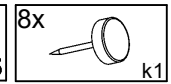
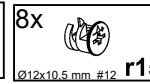
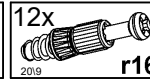
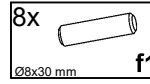

1
4x

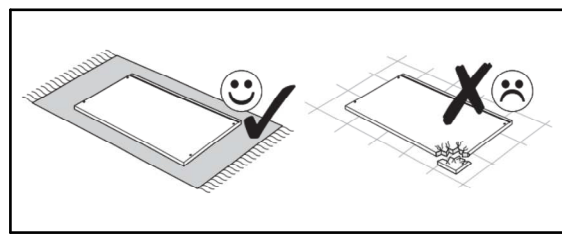
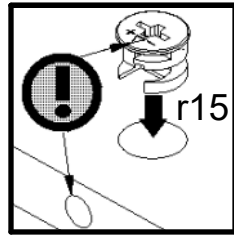
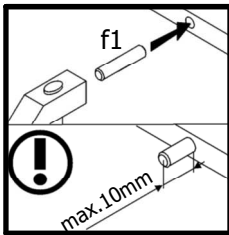
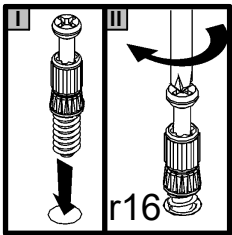
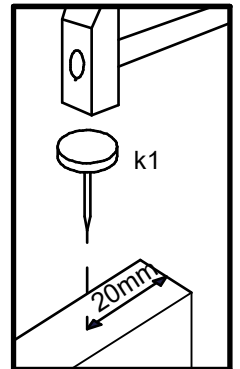
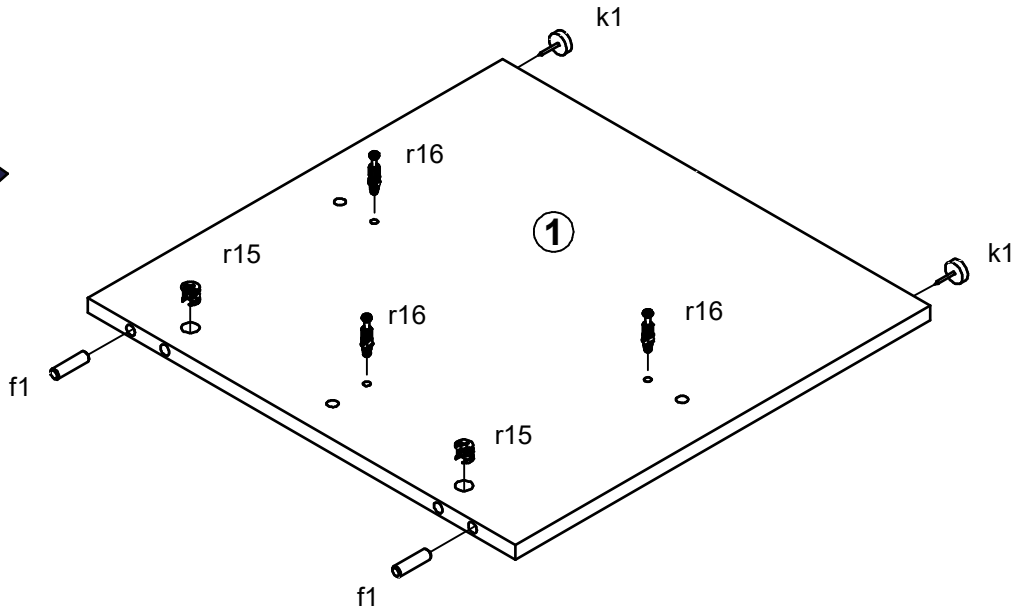

2
2x

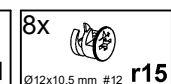
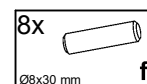
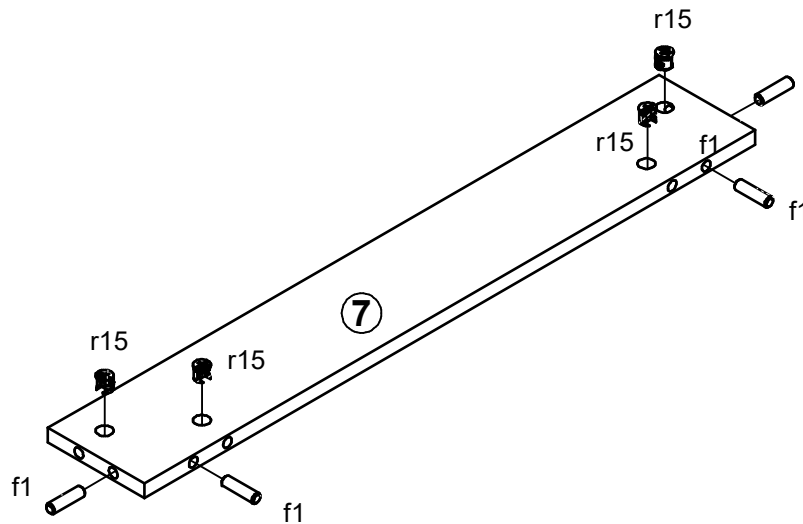

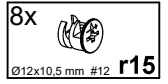
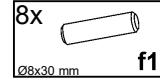

3 ▶
2x

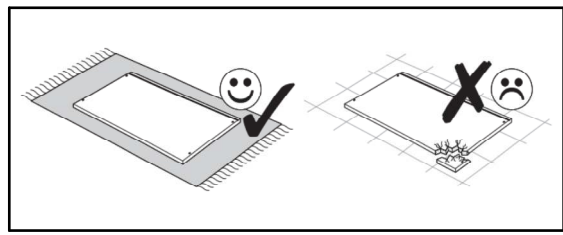
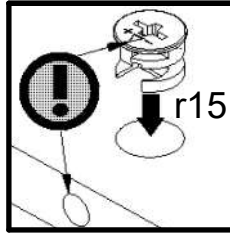
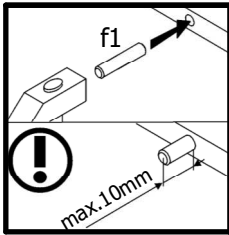
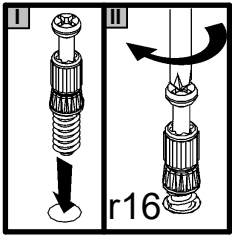
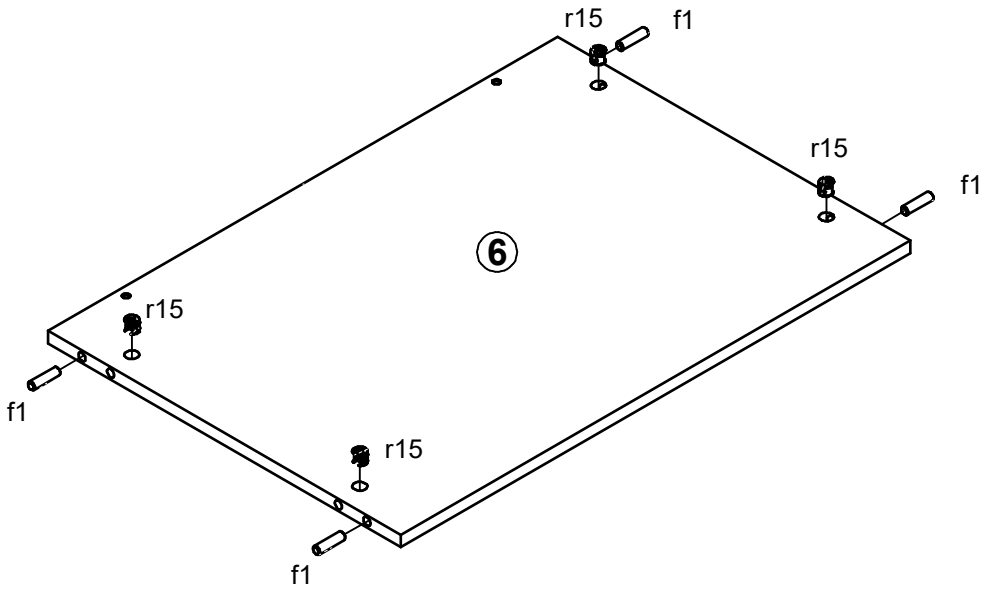

4 ▶
2x

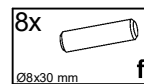
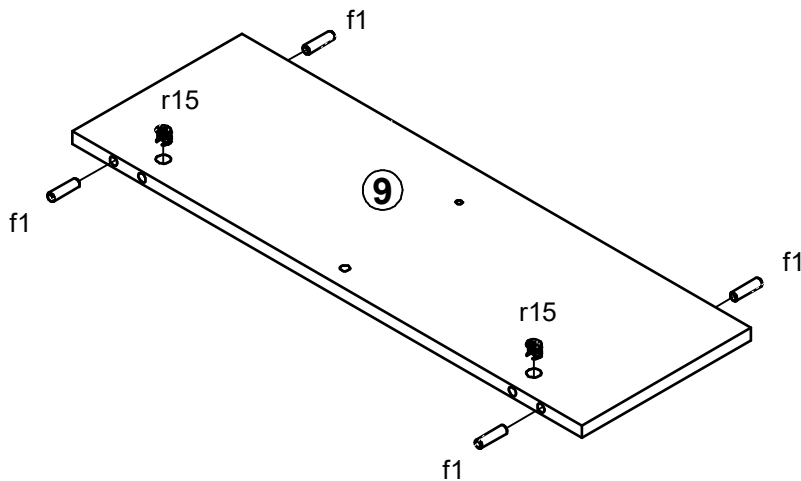

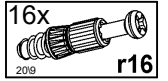

5 ▶

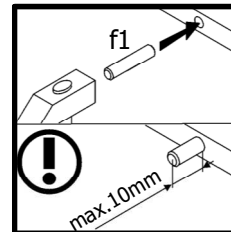
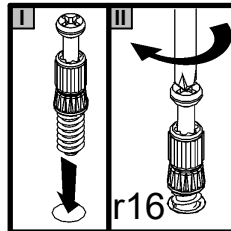
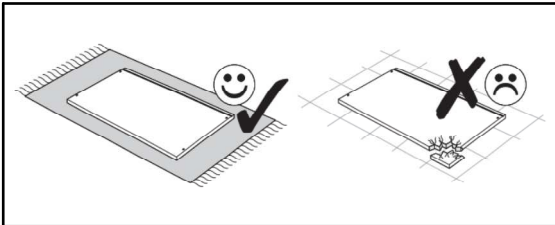
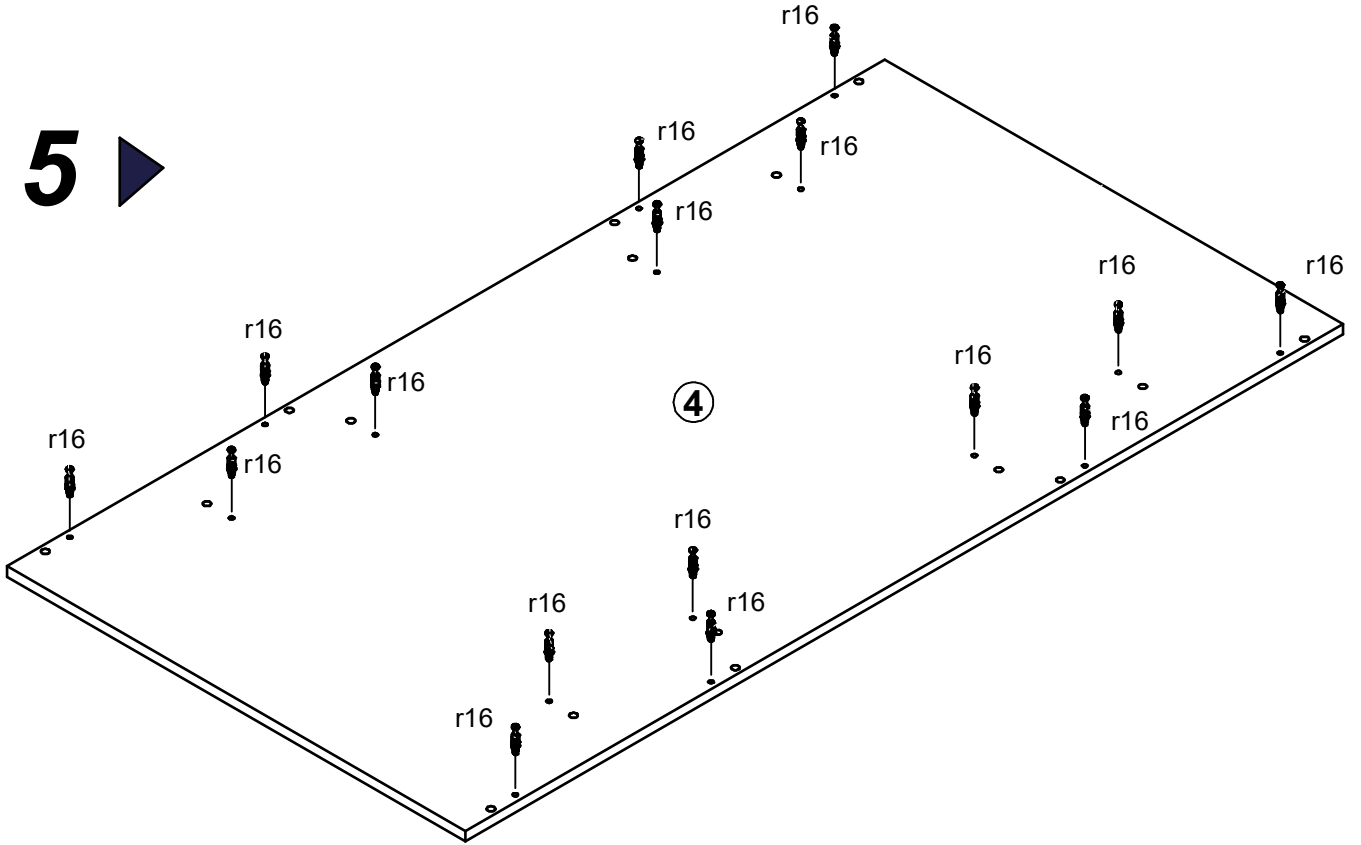

6 ▶

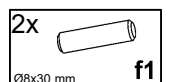
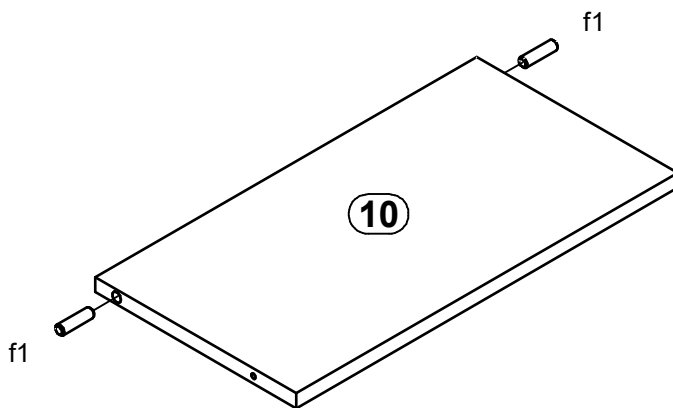

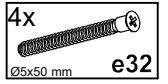

7 ▶
2x

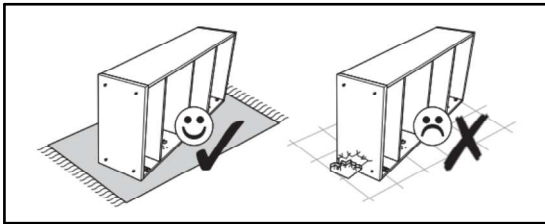
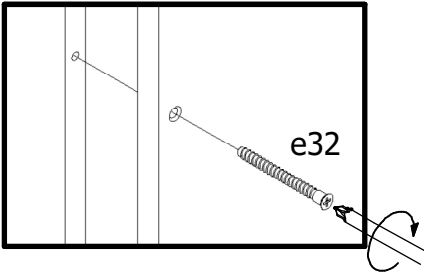
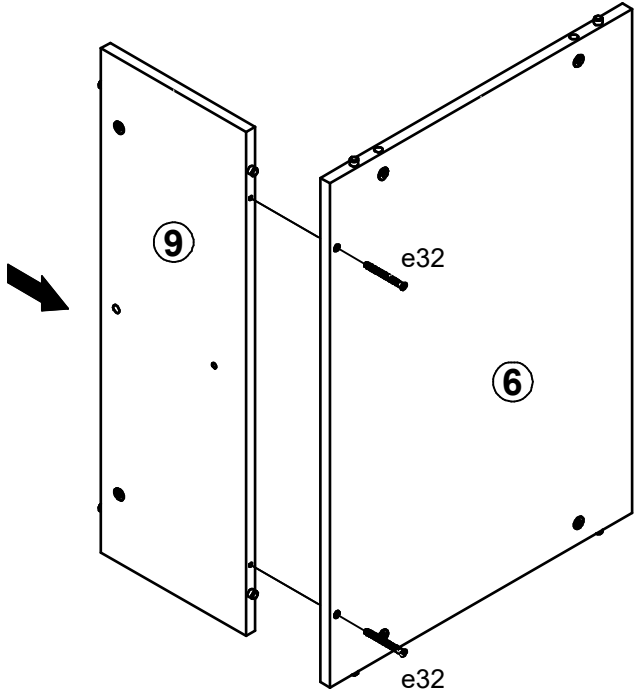

8 ▶
2x

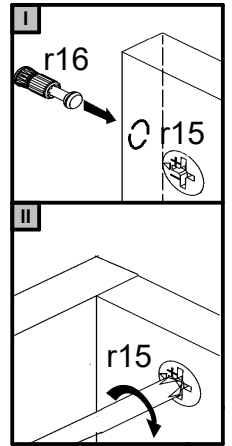
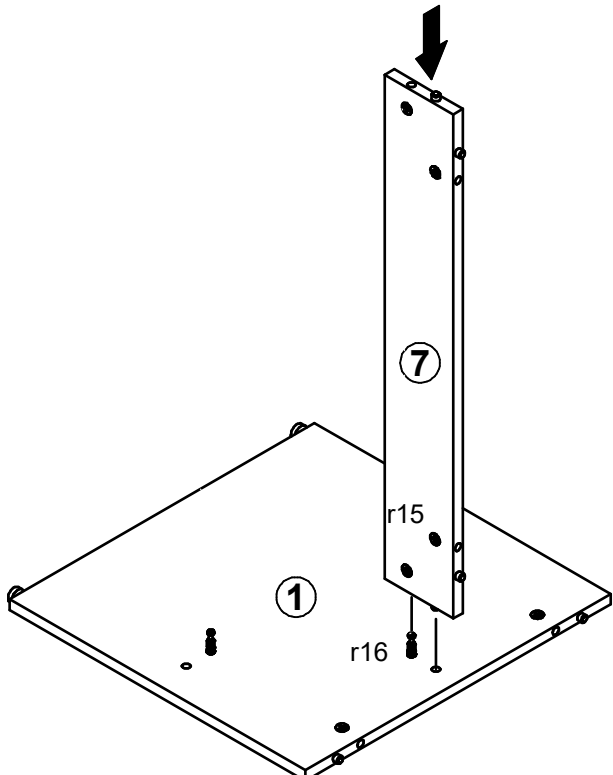

9 ▶
2x

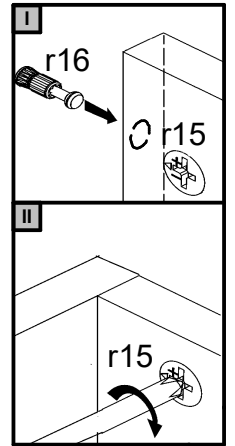
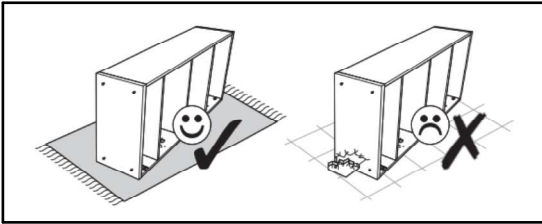
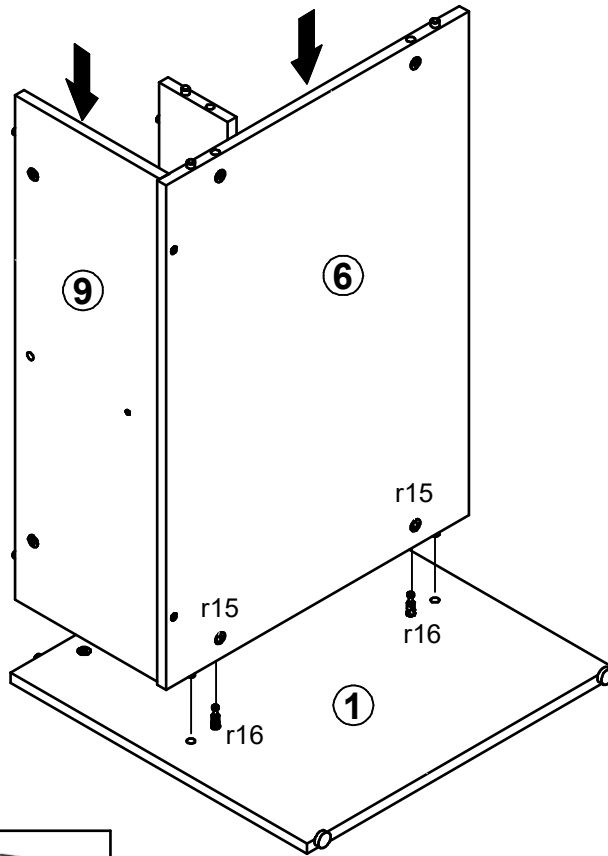

10 ▶
2x

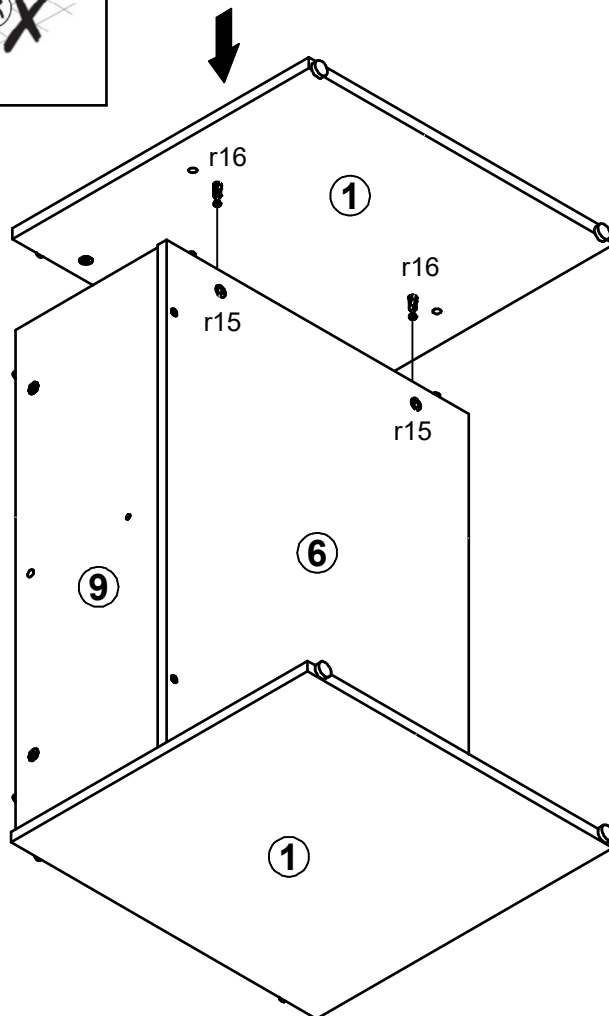

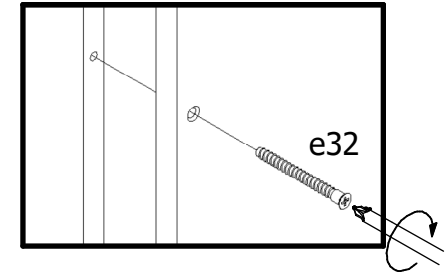
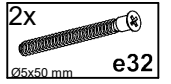

11 ▶

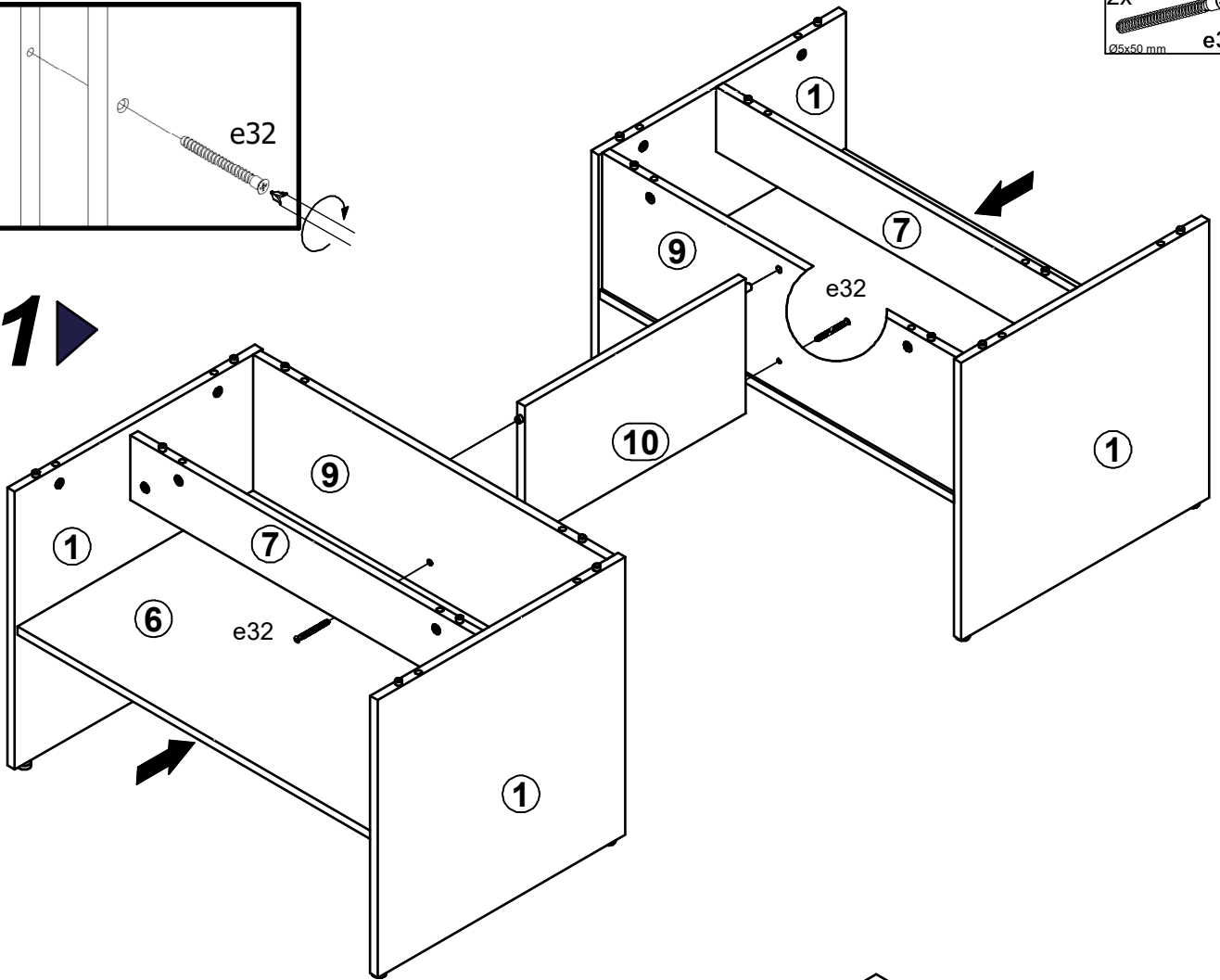

12 ▶

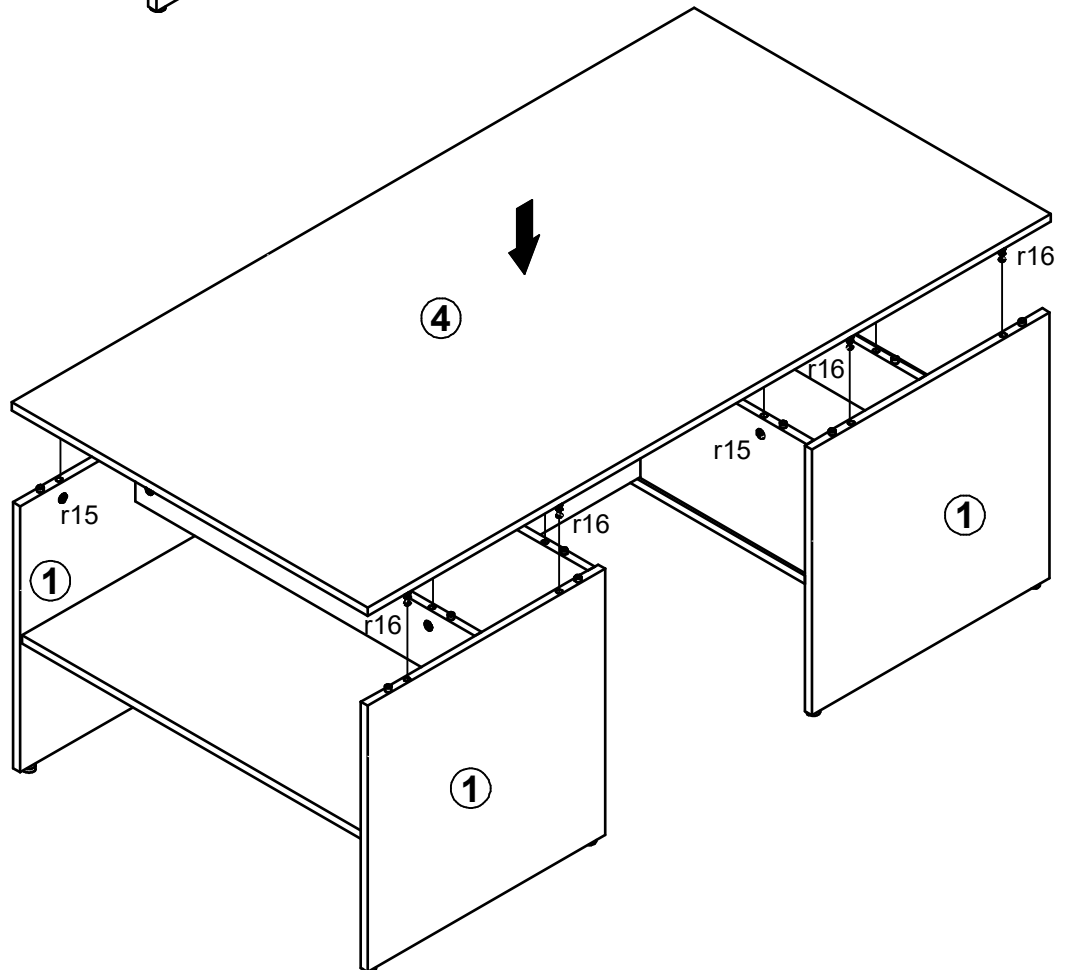
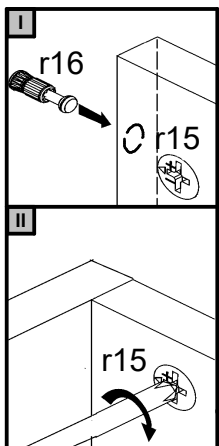

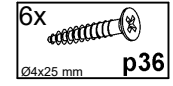
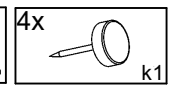
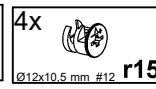
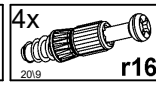
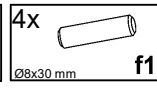
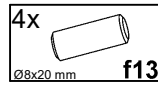
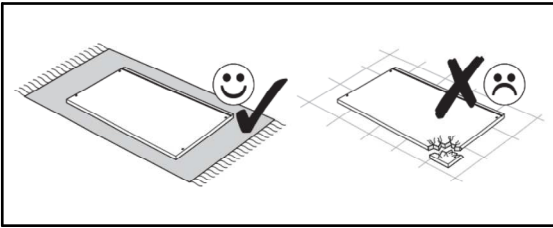

13 2x

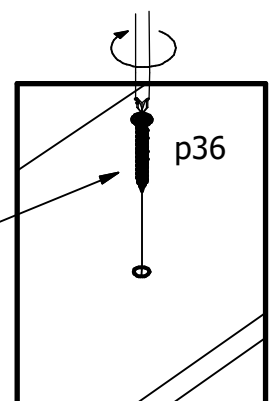
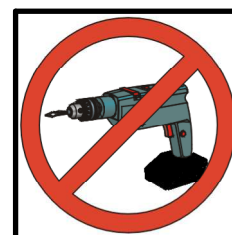
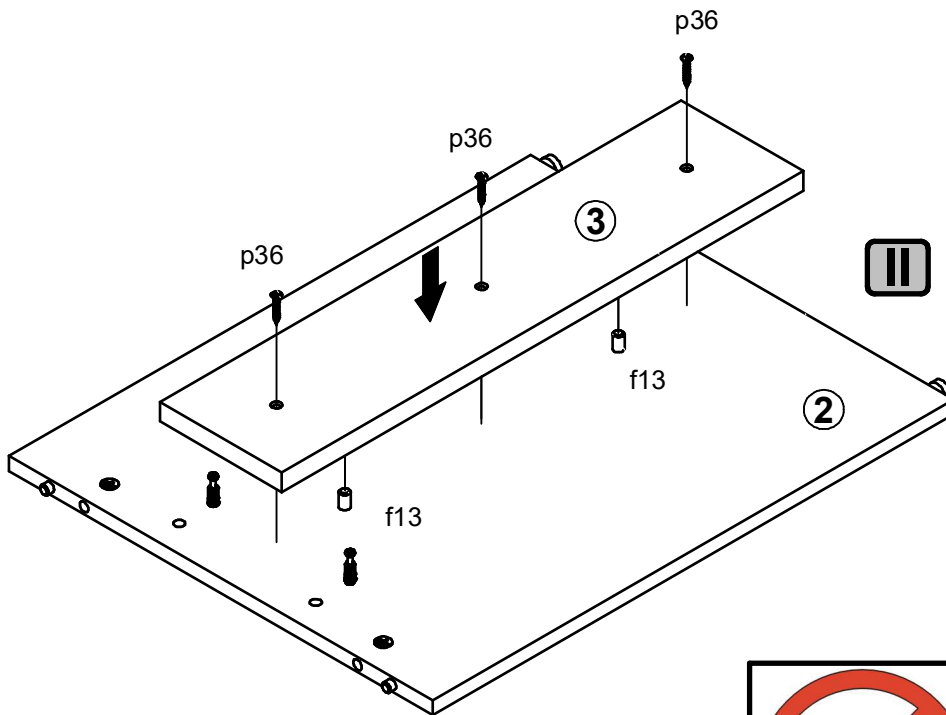
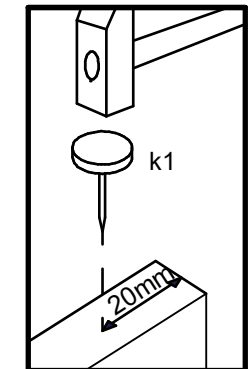
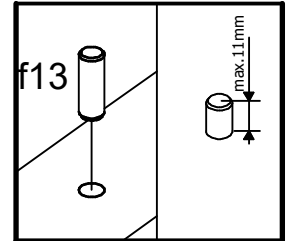
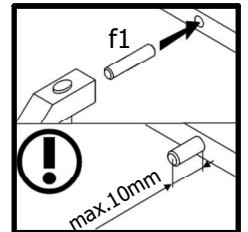
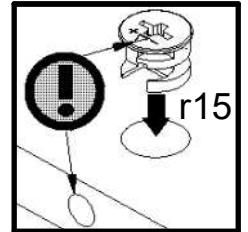
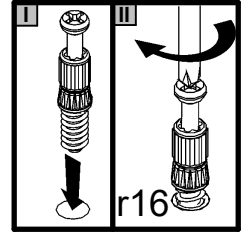
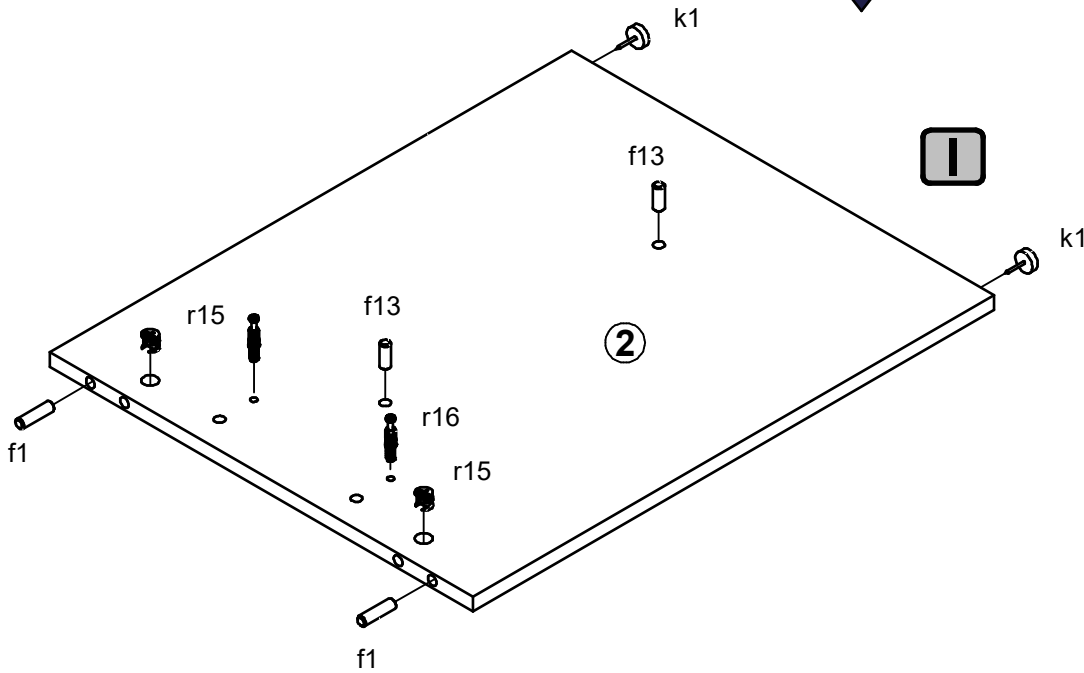

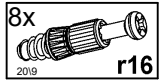

14 ▶

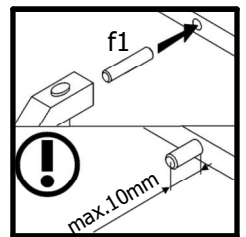
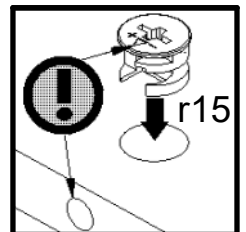
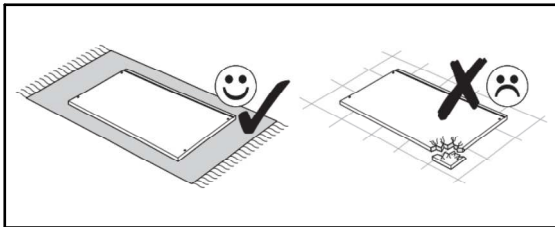
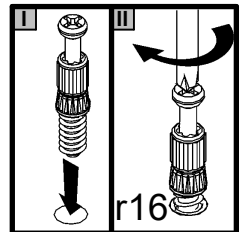
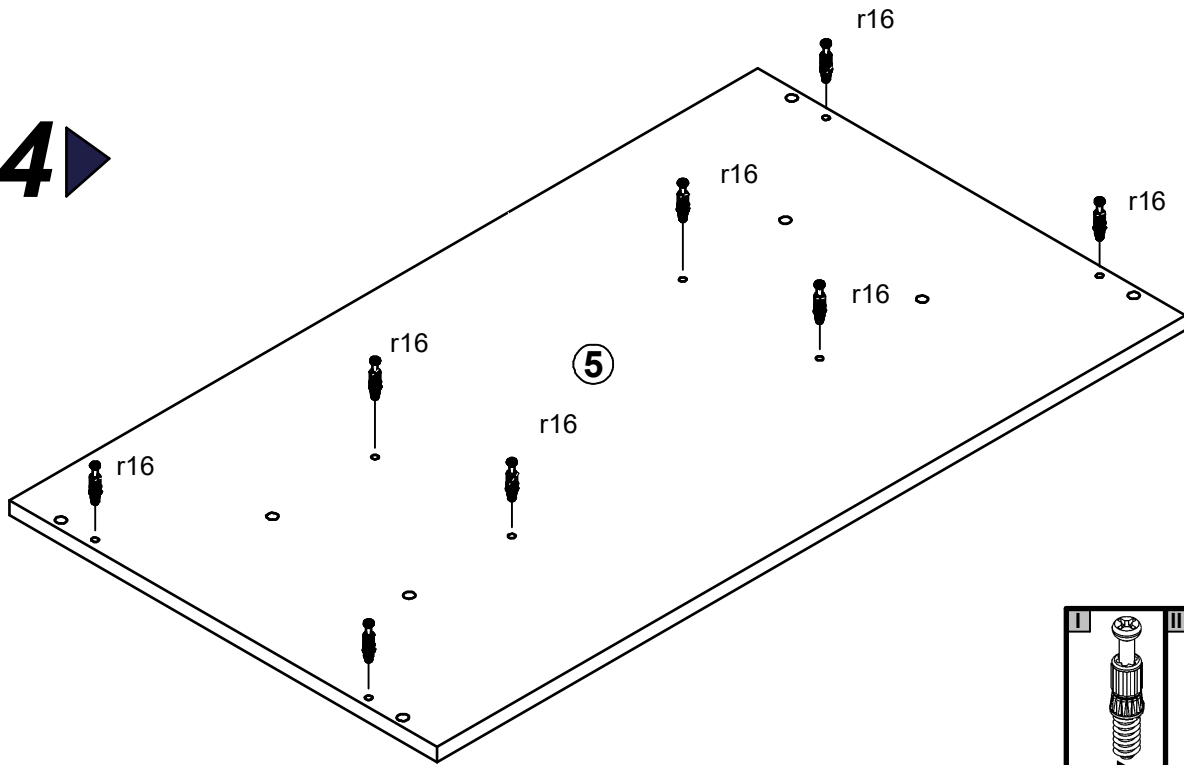

15 ▶

2x

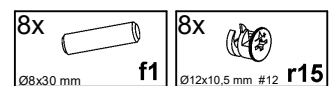
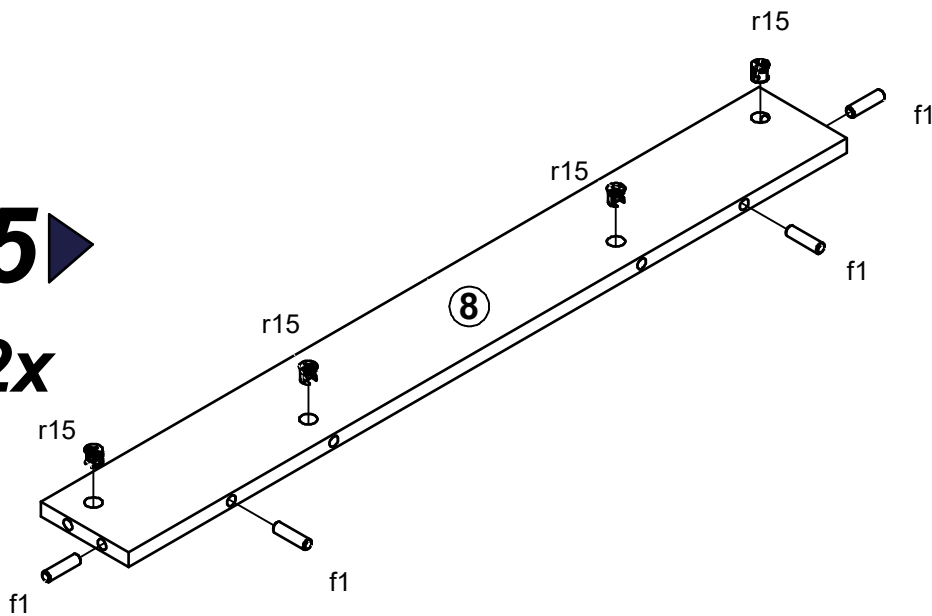

17 ▶

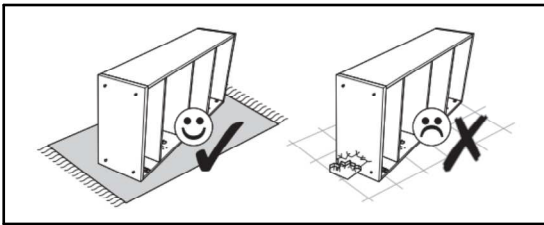
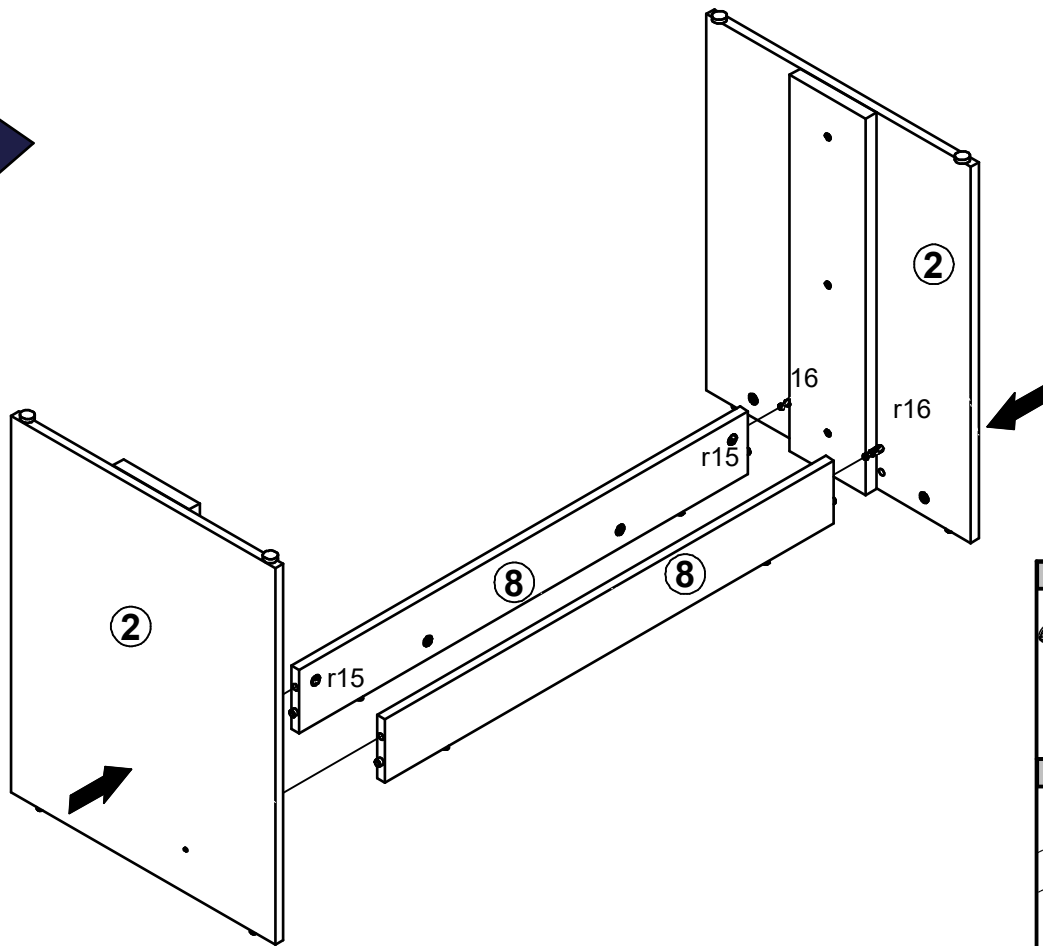

18 ▶

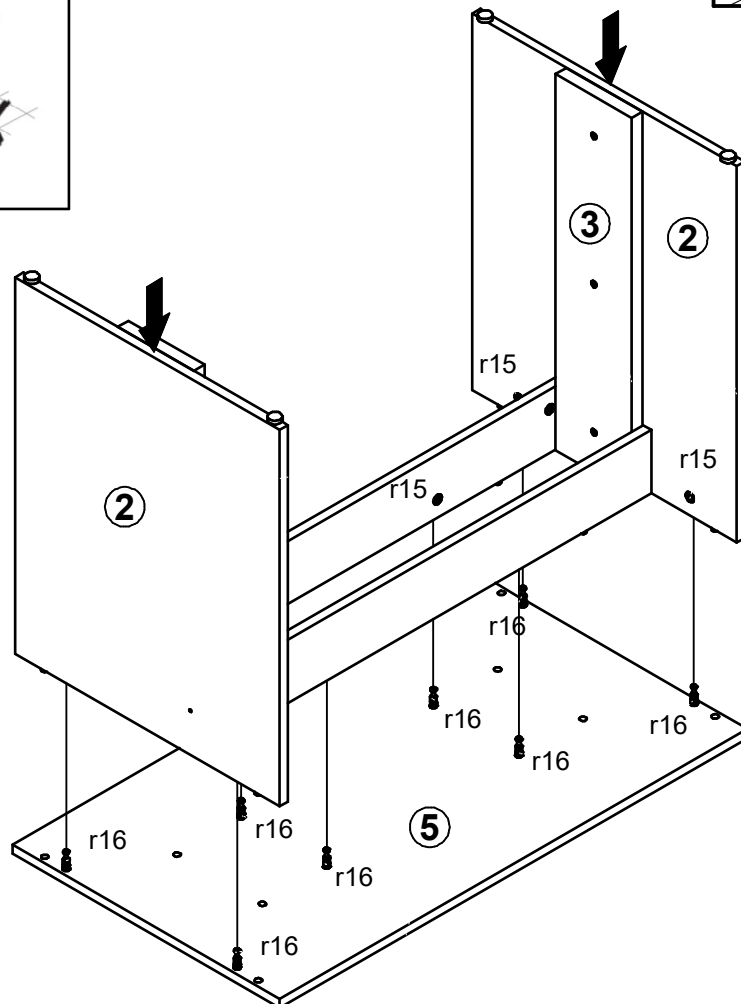

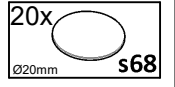
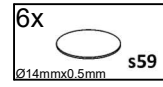
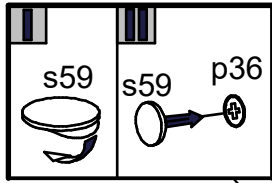

19 ▶

