

- |                                       |                                   |
|---------------------------------------|-----------------------------------|
| <b>D</b> Montageanleitung             | <b>GB</b> Assembly instructions   |
| <b>FR</b> Notice de montage           | <b>IT</b> Istruzioni di montaggio |
| <b>NL</b> Handleiding voor de montage | <b>PL</b> Instrukcja montażu      |
| <b>CZ</b> Montážní návod              | <b>SK</b> Návod na montáž         |
| <b>HU</b> Szerelési útmutató          | <b>RO</b> Instrucțiuni de montaj  |
| <b>TR</b> Montaj talimatı             | <b>RU</b> Инструкция по монтажу   |

## 7225.30 Lima 2

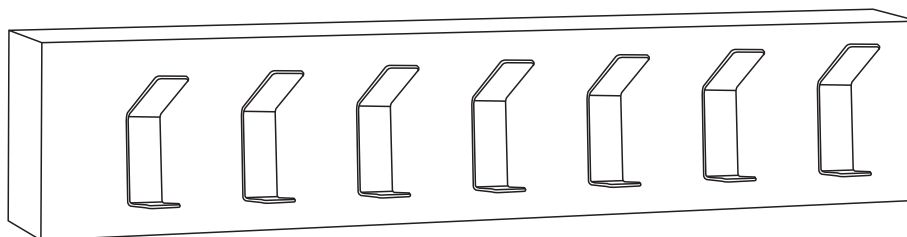

**Sehr geehrter Kunde,**

bitte lesen Sie diese Montageanleitung gut durch, da wir für Fehler, die durch falsche Montage entstehen, keine Haftung übernehmen!

Um Kratzer zu vermeiden, legen Sie Ihr Möbelstück während der Montage auf einen weichen Untergrund!

Das beiliegende Montagematerial (Schrauben F und Wanddübel G ) ist nur für Massivwände geeignet. Informieren Sie sich vor der Wandmontage über das geeignete Montagematerial für Ihre Wand!







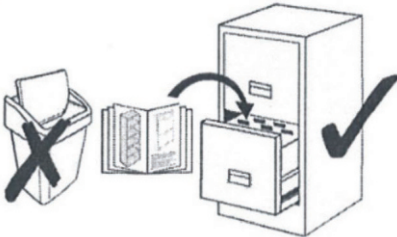

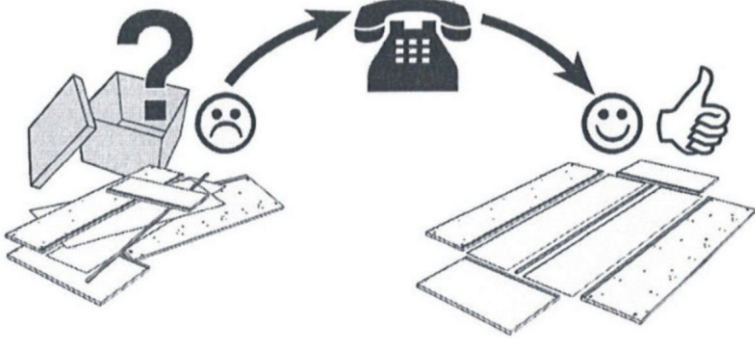

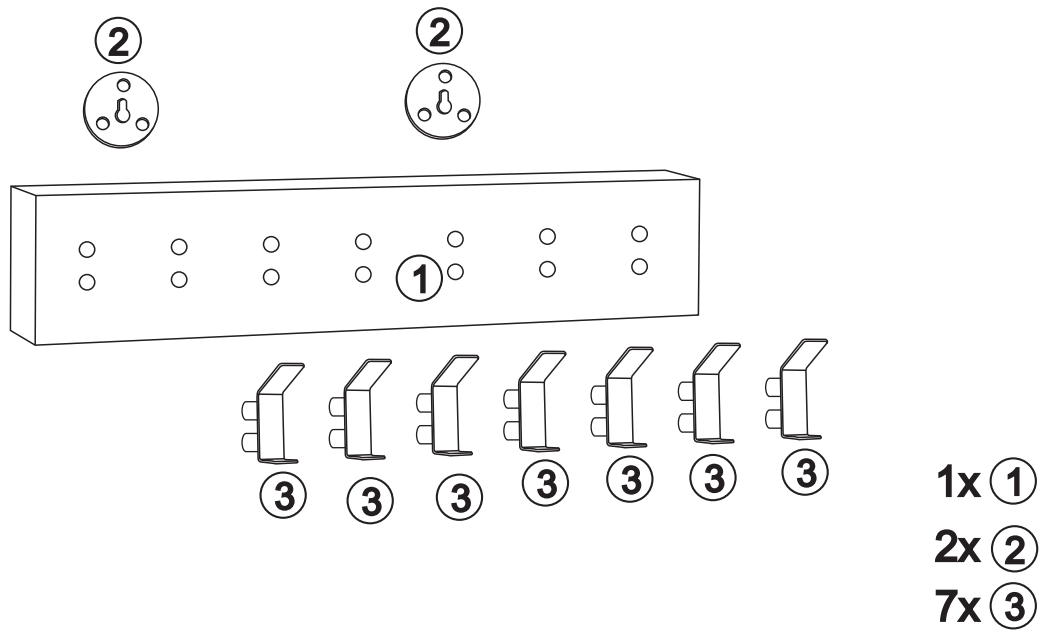
**Service • Assistenza • Dienstverlening • Serwis  
 Servis • Szerviz • Сервисная служба**

Name • Nom • Nome • Naam Nazwa • Jméno • Názov • Név Denumire • Ísím • Название	
Nr. • No. • N° • Номер • Č • Sz	
Tур • Type • Tip • Típus • Тип	
	







- |   |  |   |   |  |  |  |
|---|--|---|---|--|--|--|
| <b>A</b><br><br>25MM <b>X6</b> | <b>B</b><br><br><b>X1</b> | <b>C</b><br><br>M6*40MM <b>X14</b> | <b>D</b><br><br>M6*14MM <b>X14</b> | <b>E</b><br><br><b>X1</b> | <b>F</b><br><br>30MM <b>X2</b> | <b>G</b><br><br><b>X2</b> |
|---|--|---|---|--|--|--|

**A**

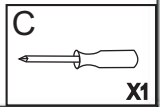
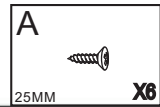
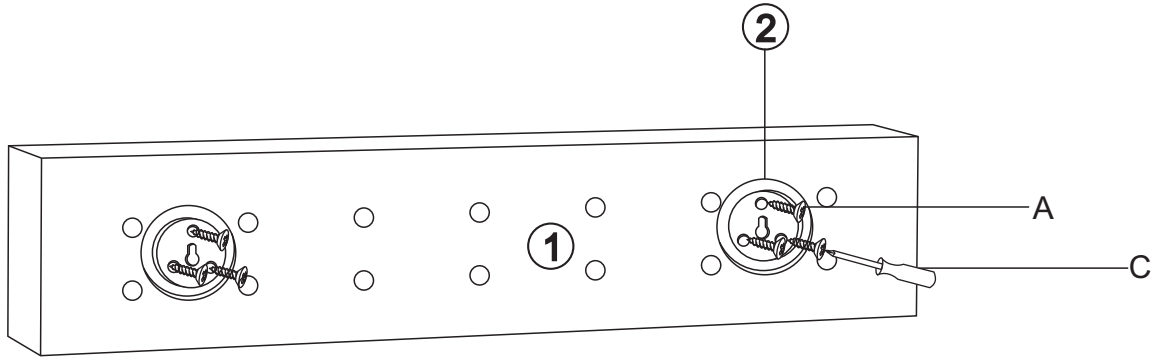
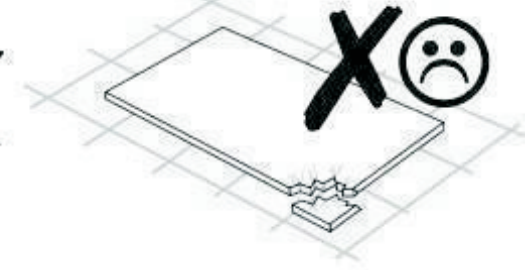
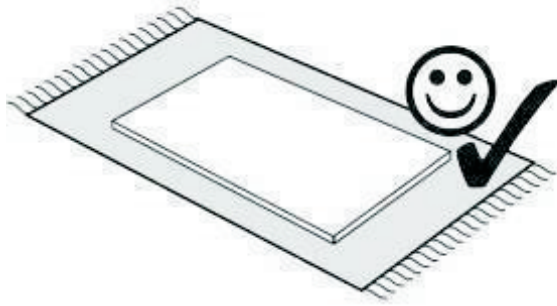

**B**

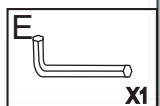
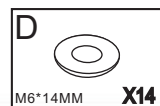
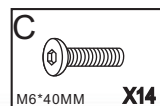
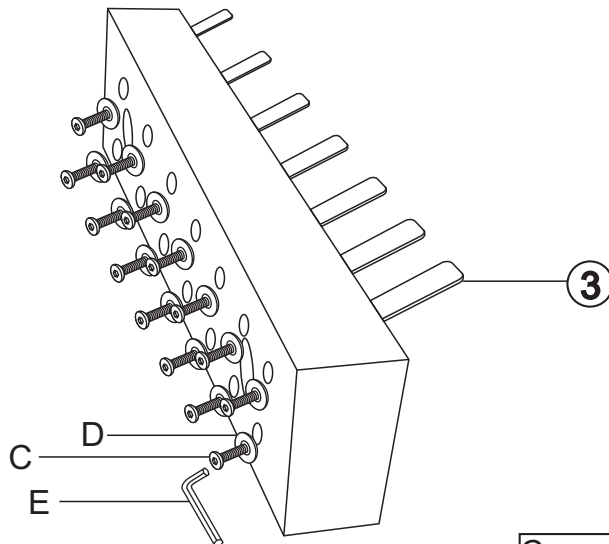
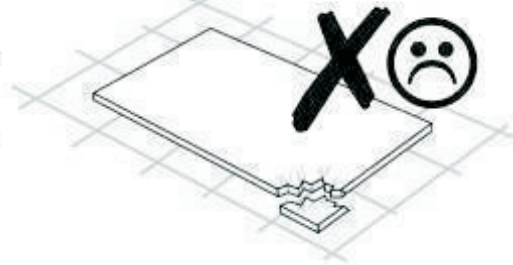
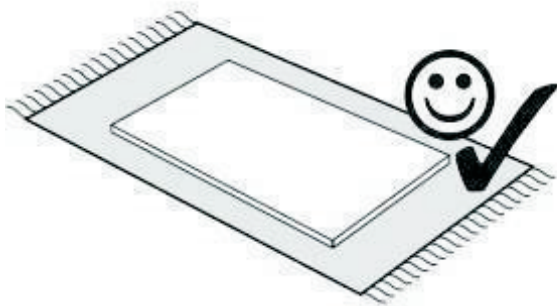

**C**

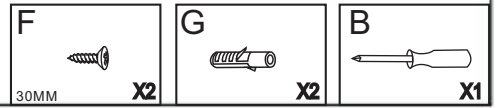
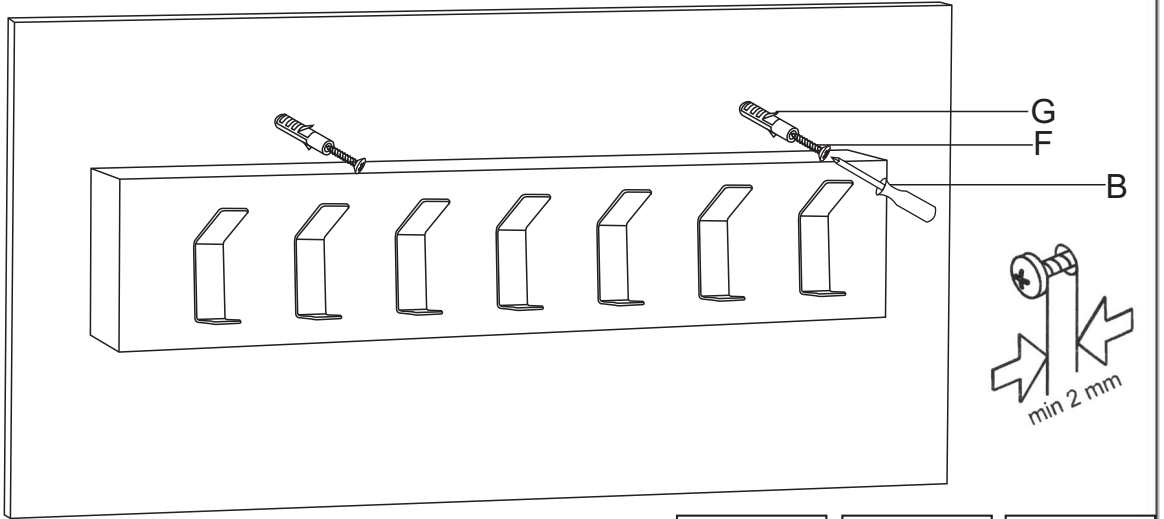
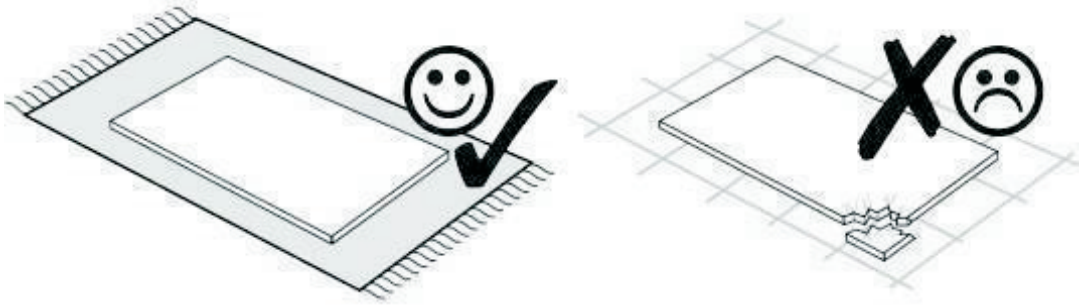

**D**

