

**A****S643-POL/33/80****CONNECT**

**24270215/19**  
**24270215/20**

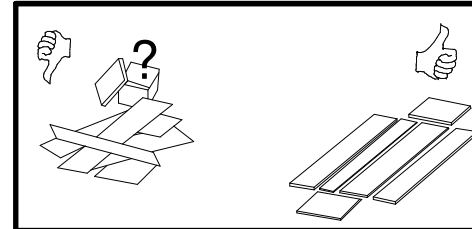

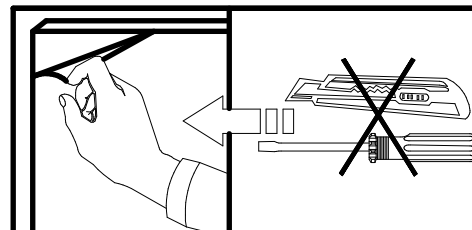
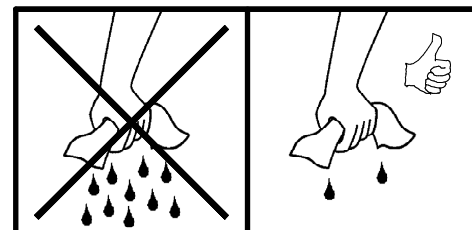
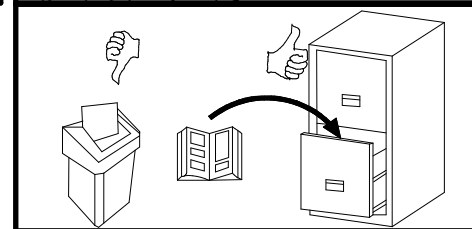
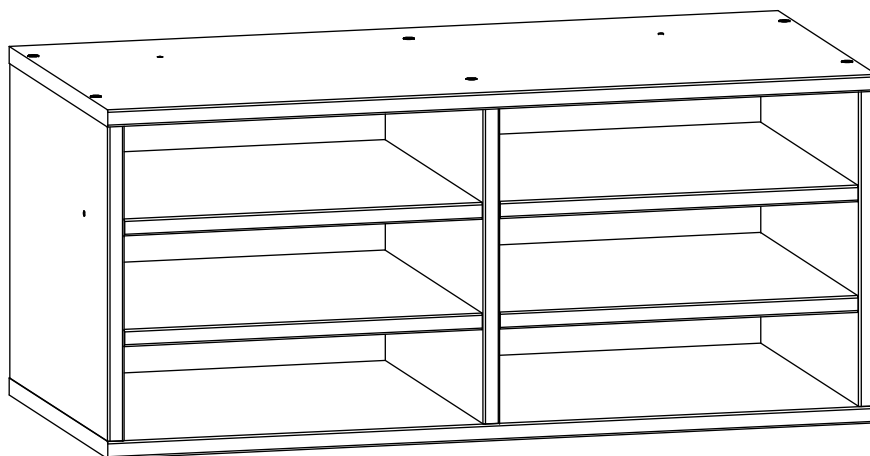
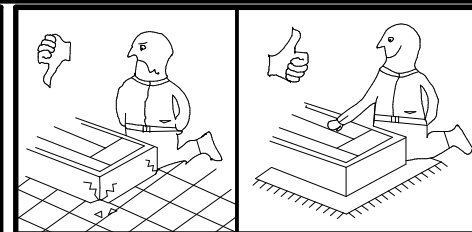
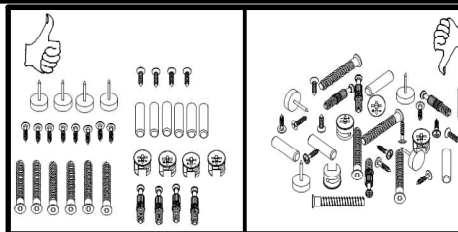
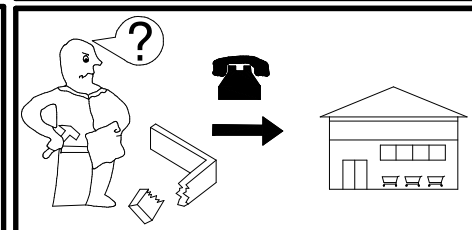
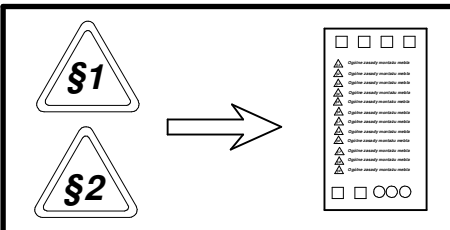
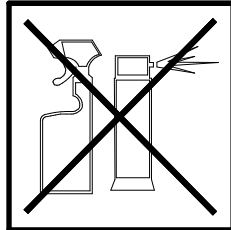
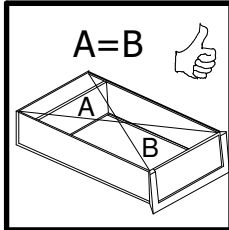
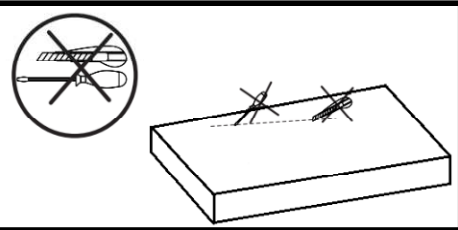
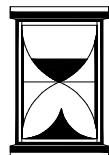
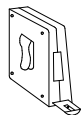
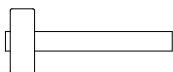
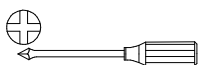
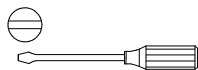
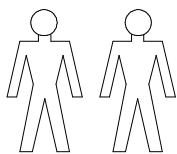

20 min

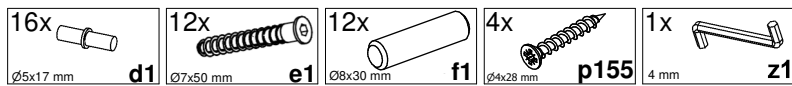

A	B1	B2	C1	C2	C3	D
1	S643-1009	-	296	351	16	1/1
2	S643-1010	-	296	351	16	1/1
3	S643-1011	-	296	351	16	1/1
4	S643-2010	-	737	353	16	1/1
5	S643-2011	-	737	353	16	1/1
6	S643-3004	-	343	349	16	1/1



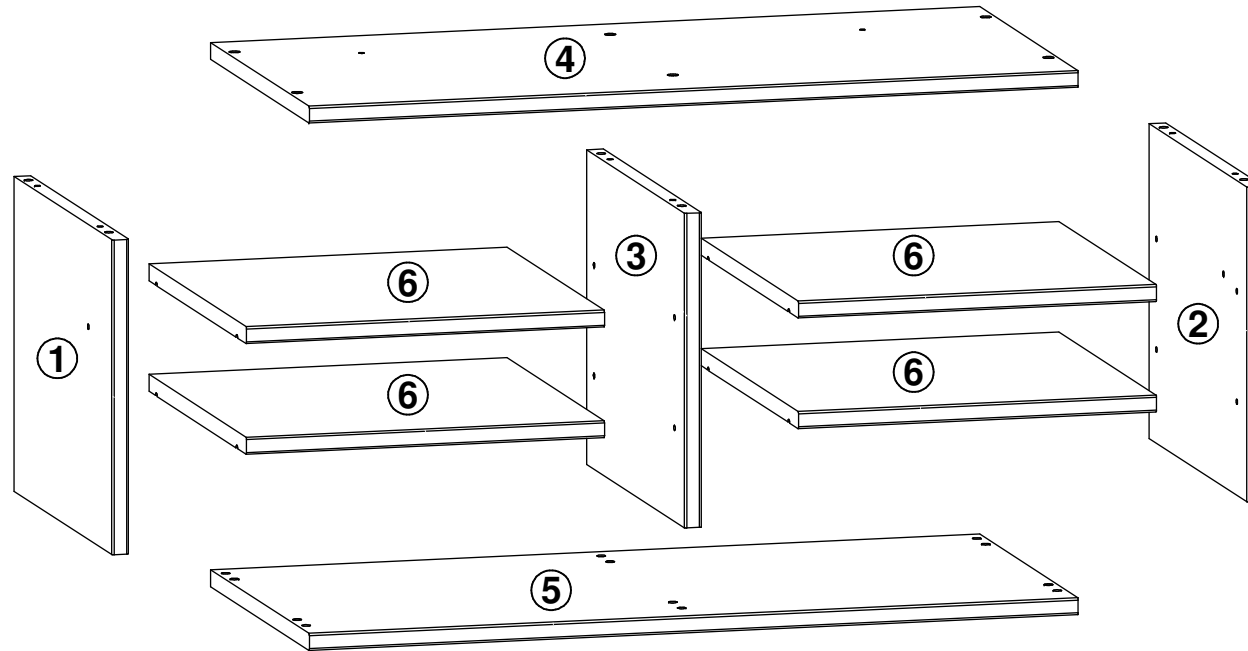

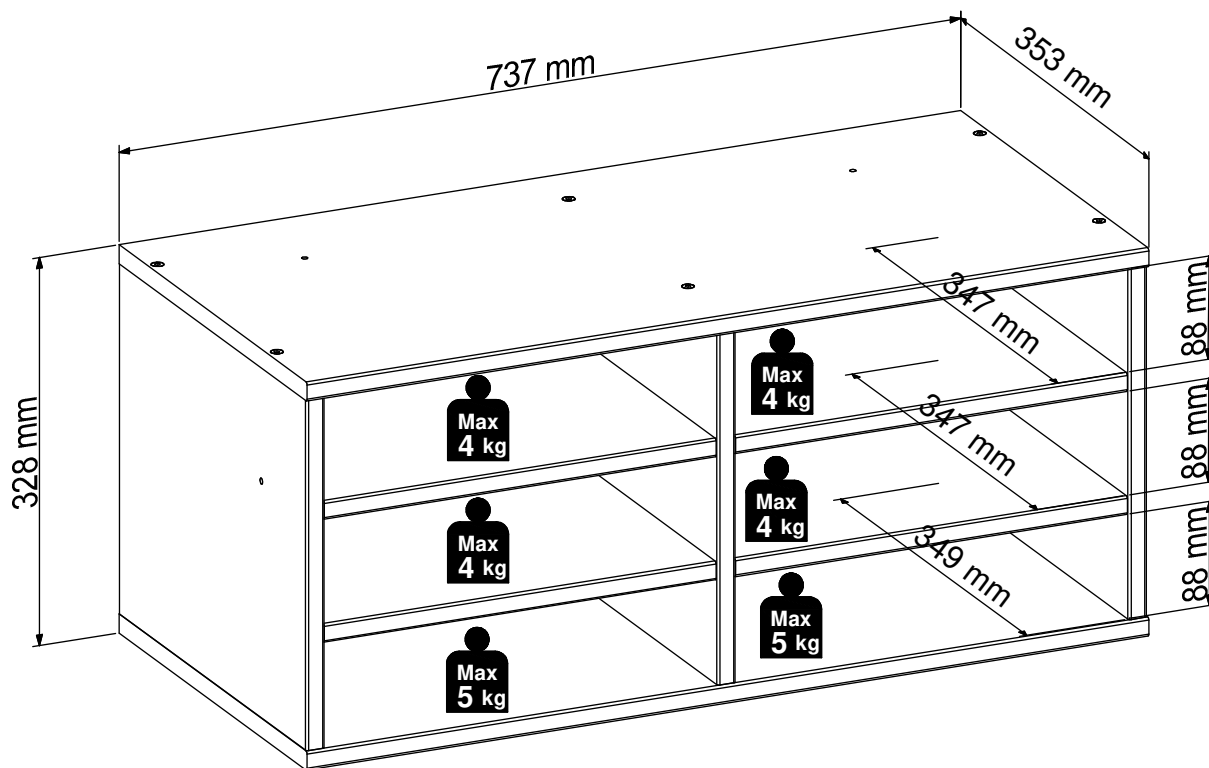

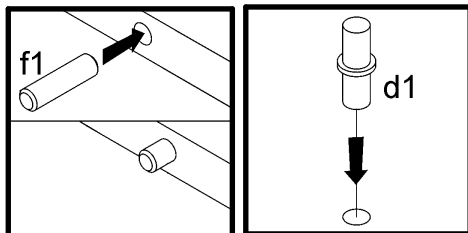
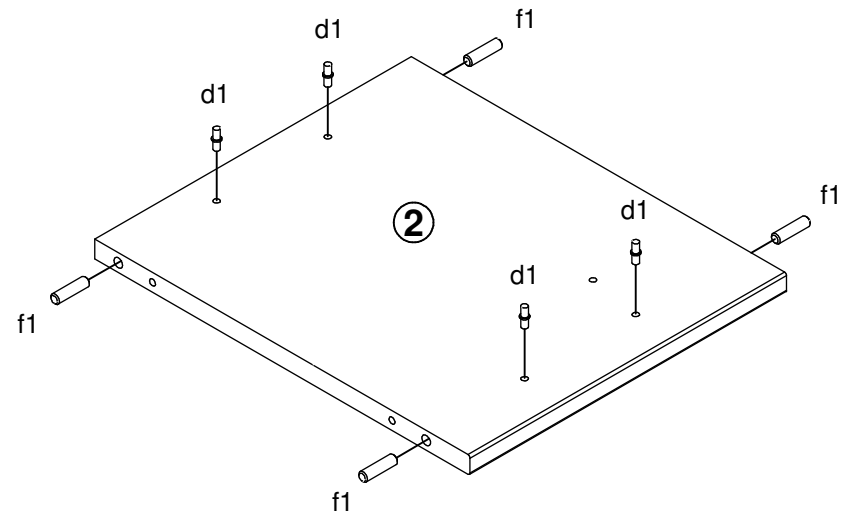
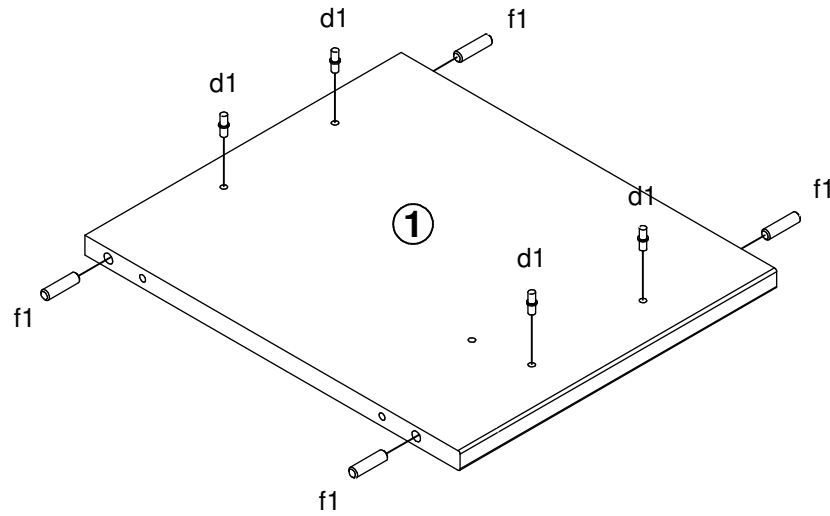
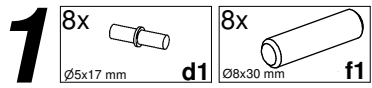

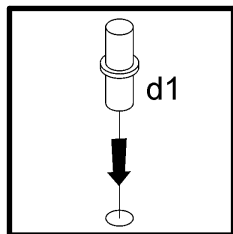
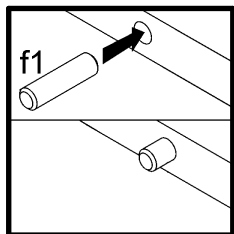
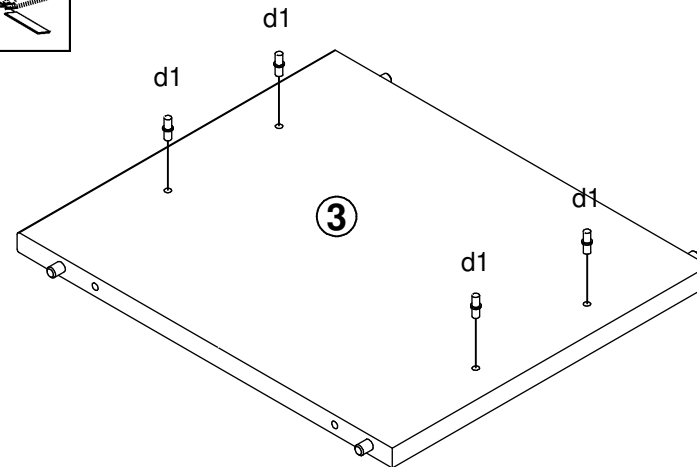
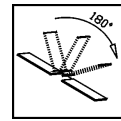
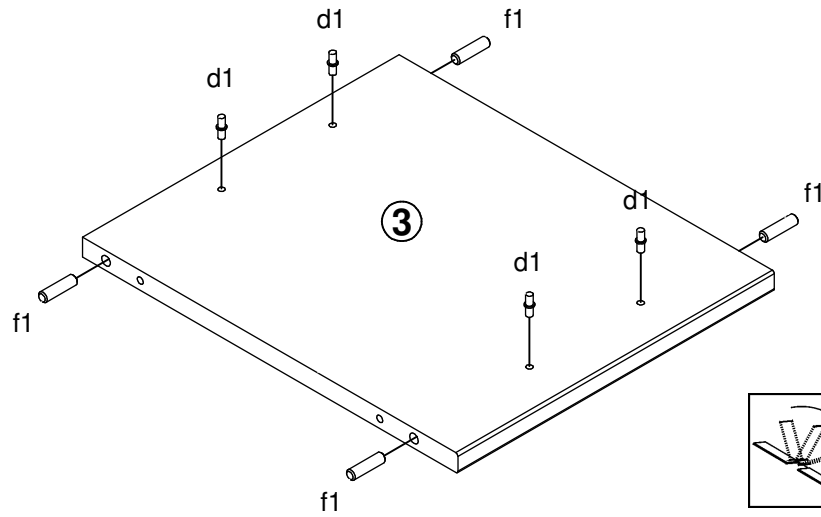
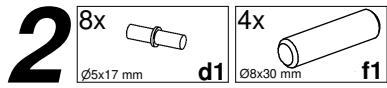

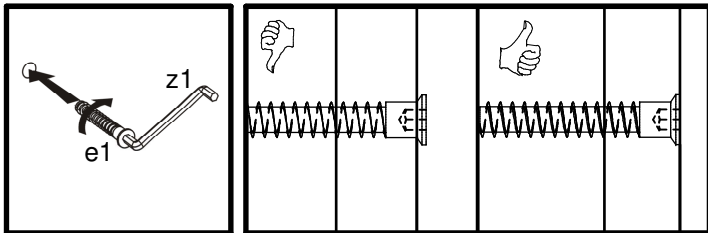
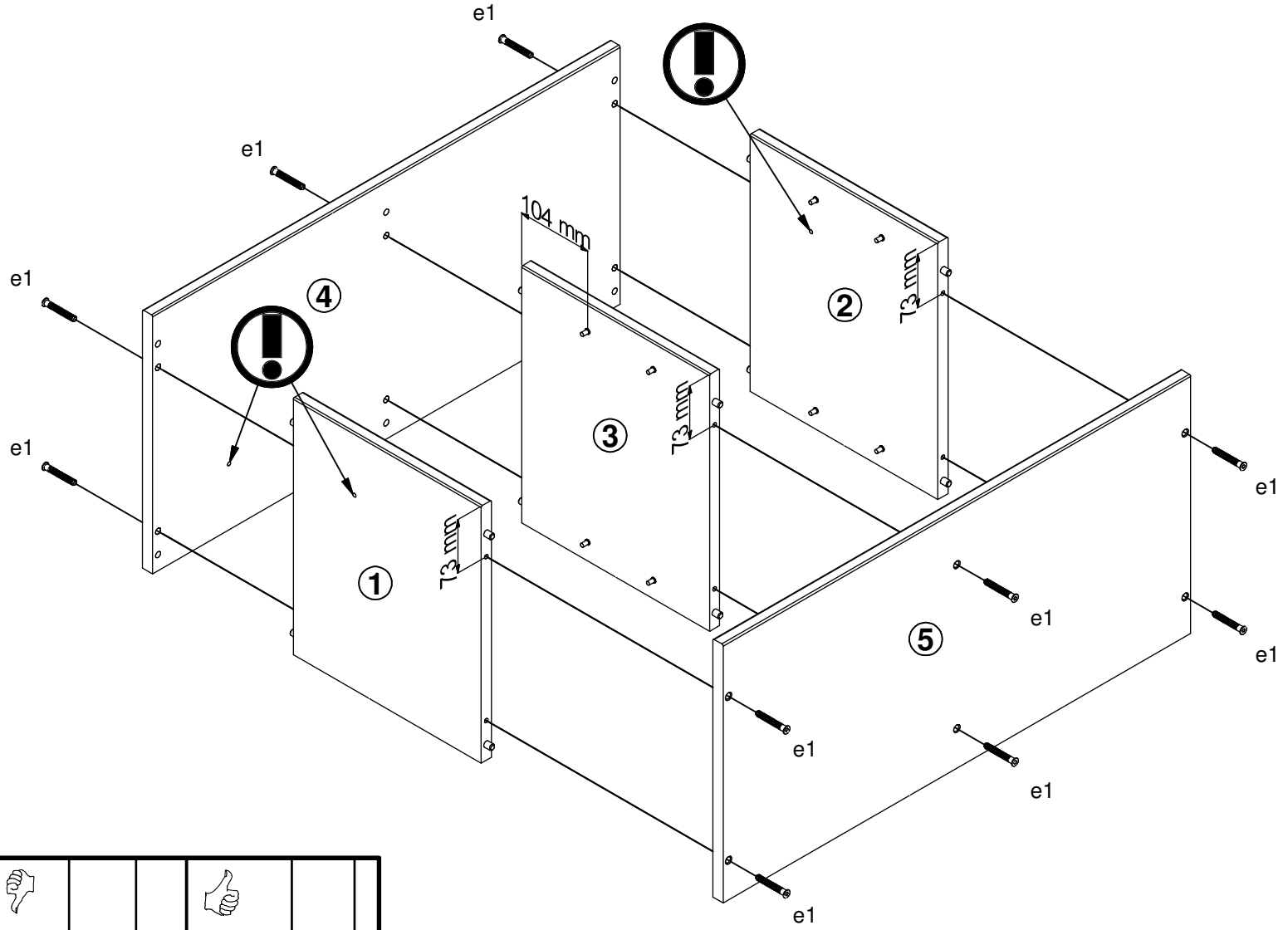
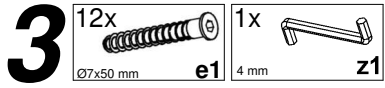

4

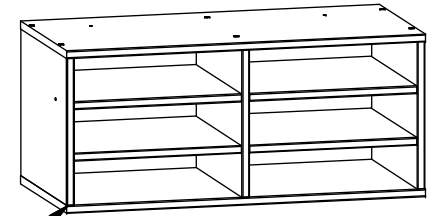
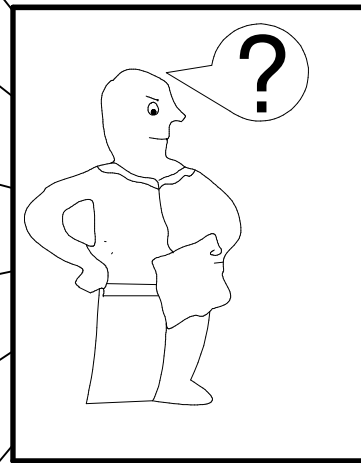
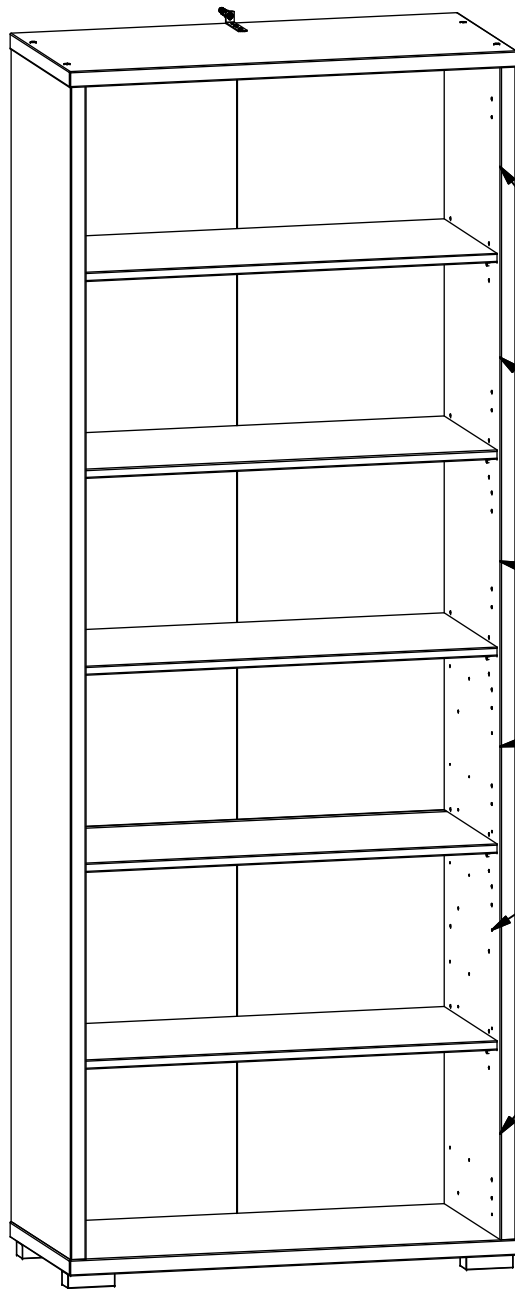



5

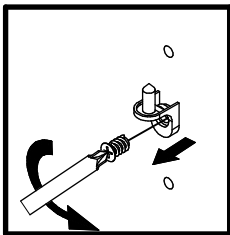
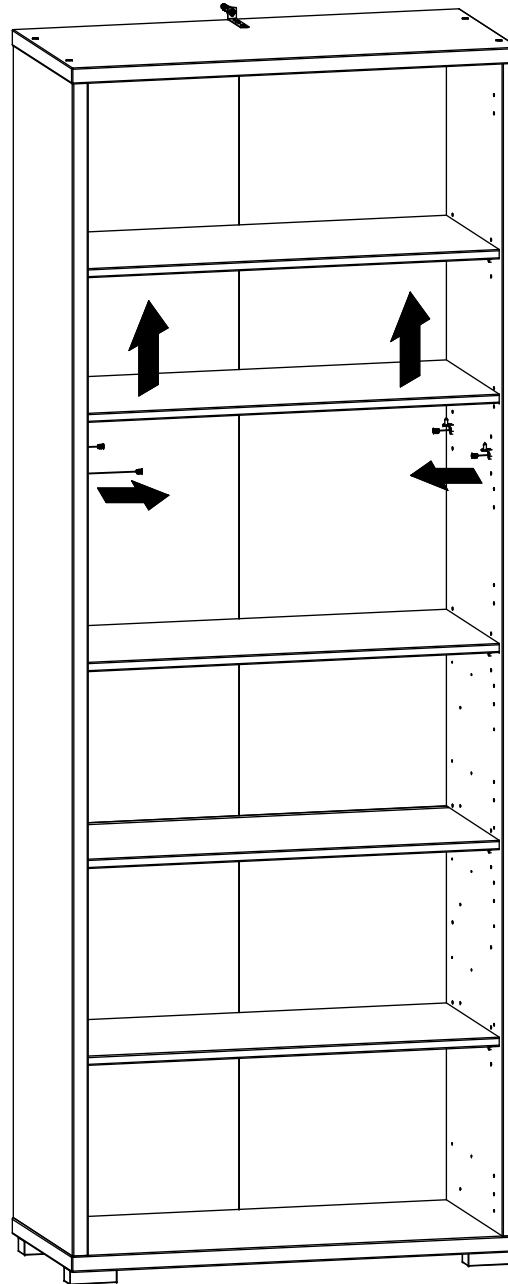

6

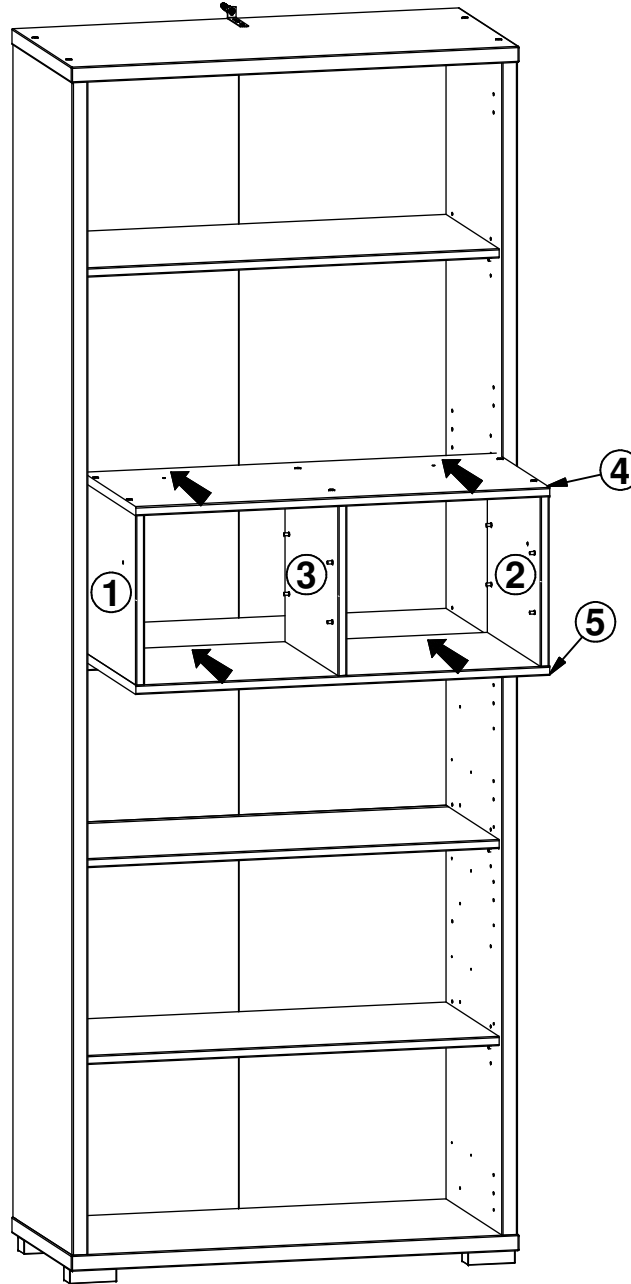

7

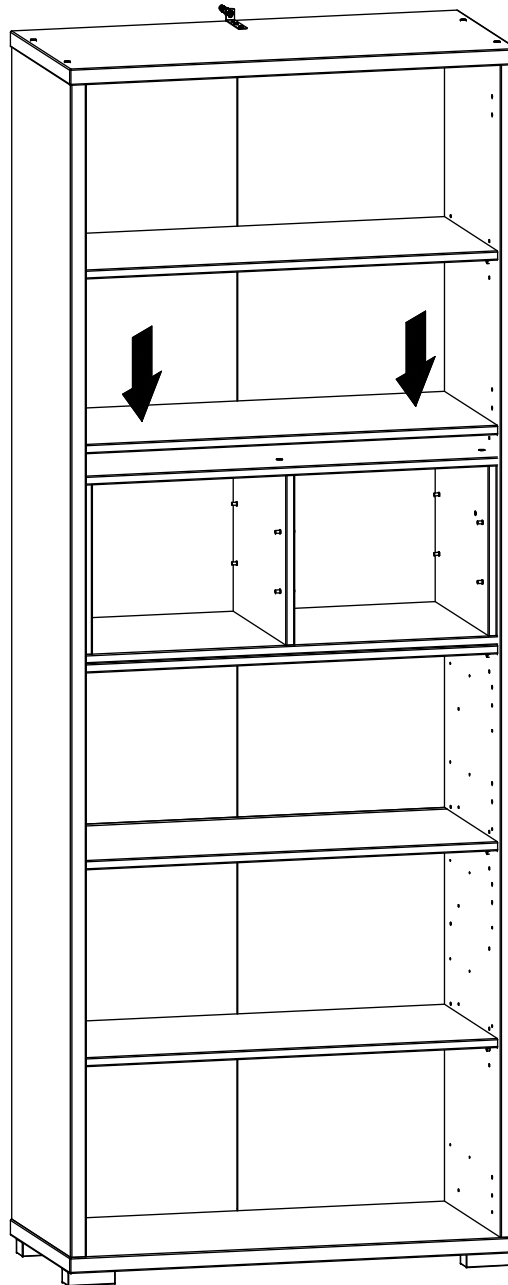

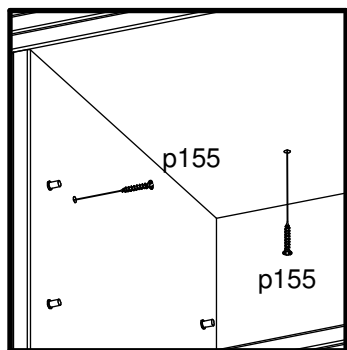
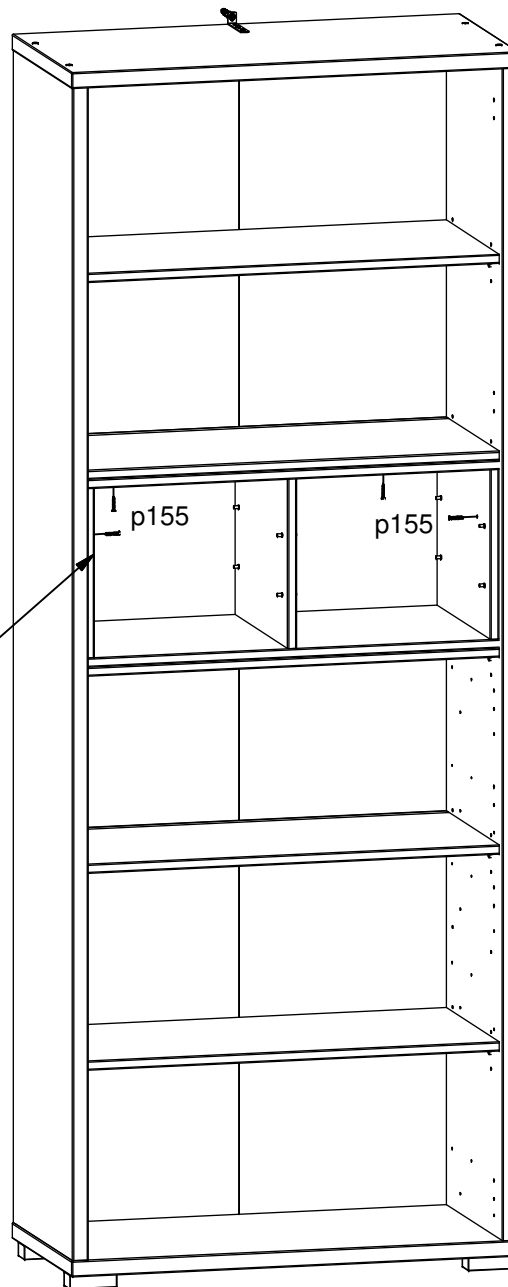
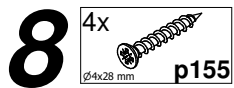

9

