

EASY TYP 302/304/306

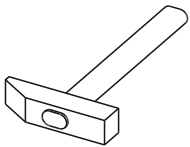

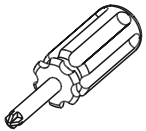

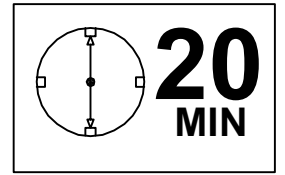

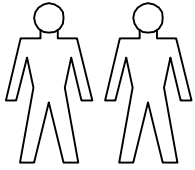
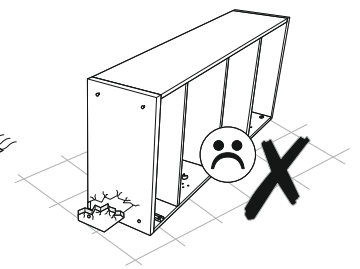
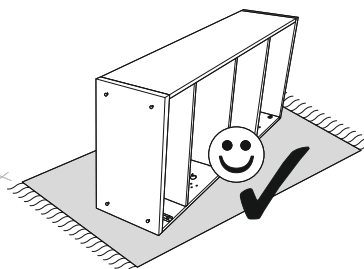
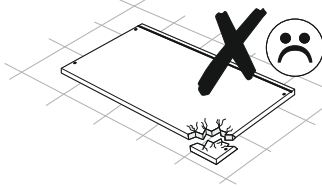
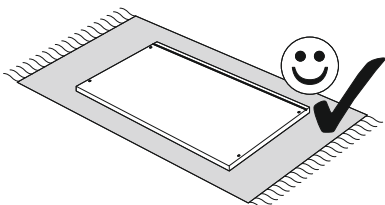
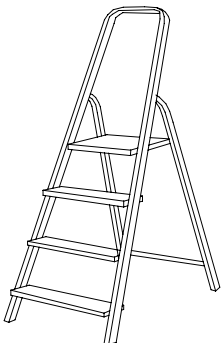
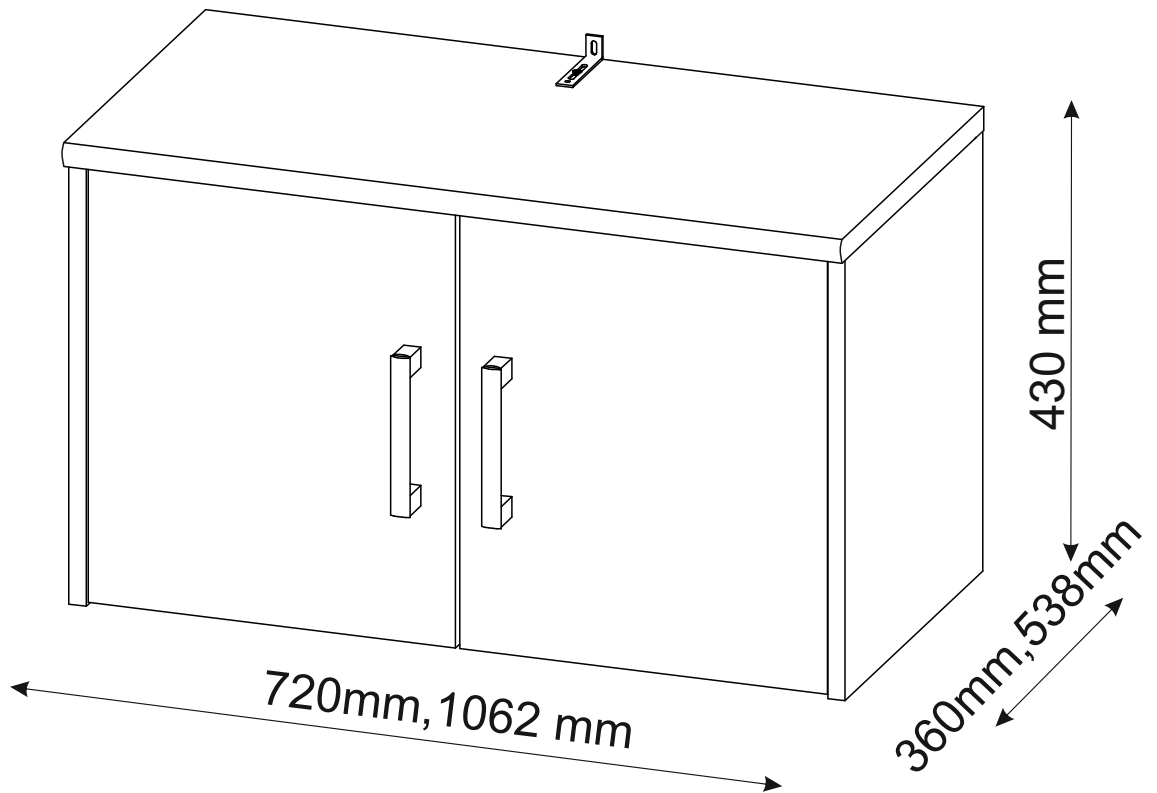

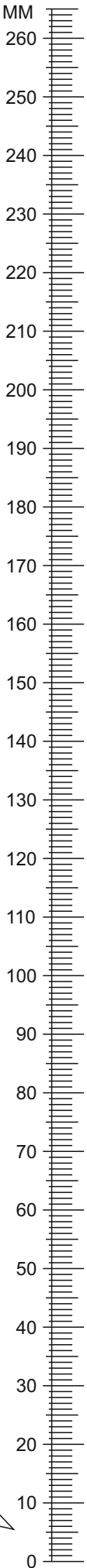



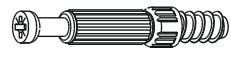

Ø8

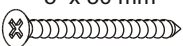
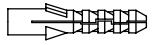

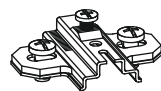
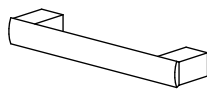
EASY TYP 302/304/306

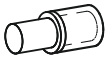

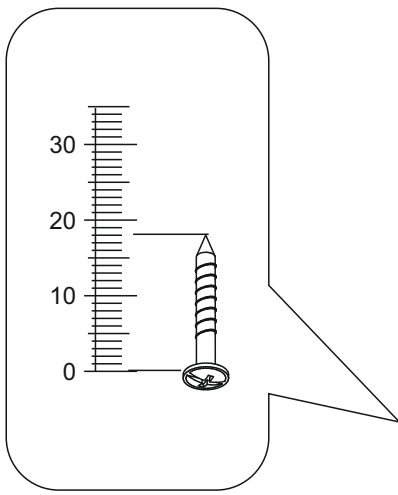

A0 8 x 30mm x8 	C0 x4 	C2 x8 
C7 x8  16mm	D0 3 x 15 mm x10 	D10 4 x 16 mm x8 
D16 4,2 x 28 mm x8 	E0 5 x 50 mm x1  8 x 50 mm 	J4 x4 
J6 x4 	L5 x2 	M1 x10 
Q4 x2 	U0 x2 	

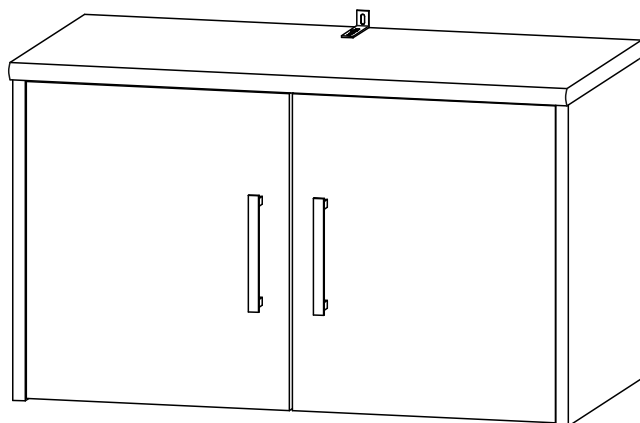

EASY TYP 302/304/306

TYP 302



1	408	350	16	x1	1/1
2	408	350	16	x1	1/1
3	686	332	16	x1	1/1
4	402	340	16	x2	1/1
5	720	360	22	x1	1/1
6	401,5	348	2,8	x1	1/1
					1/1

TYP 304

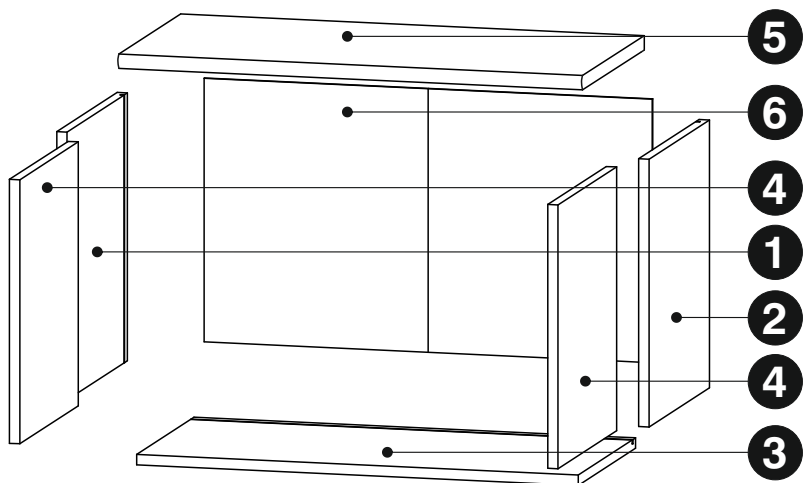



1	408	528	16	x1	1/1
2	408	528	16	x1	1/1
3	686	510	16	x1	1/1
4	402	340	16	x2	1/1
5	720	538	22	x1	1/1
6	401,5	348	2,8	x1	1/1
					1/1

TYP 306

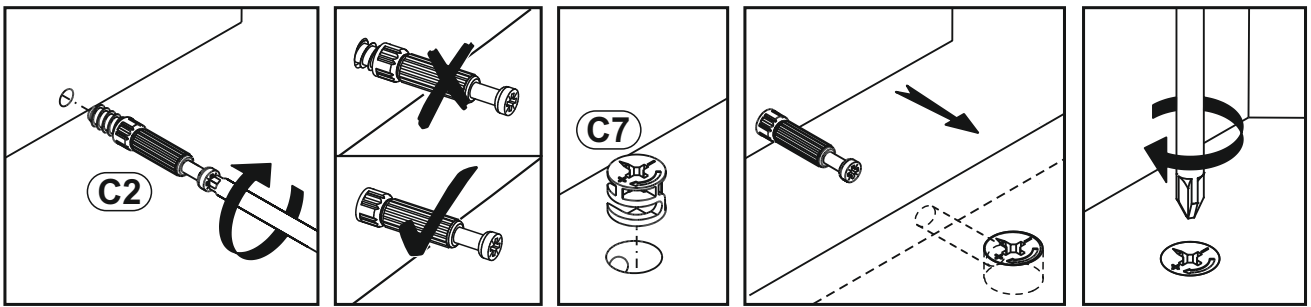
1	408	528	16	x1	1/1
2	408	528	16	x1	1/1
3	1028	510	16	x1	1/1
4	402	511	16	x2	1/1
5	1062	538	22	x1	1/1
6	401,5	1038	2,8	x1	1/1
					1/1



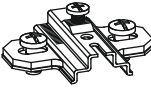

1 ▶

A0	8 x 30mm	x2	C2		x2	C7		x2
						16mm		

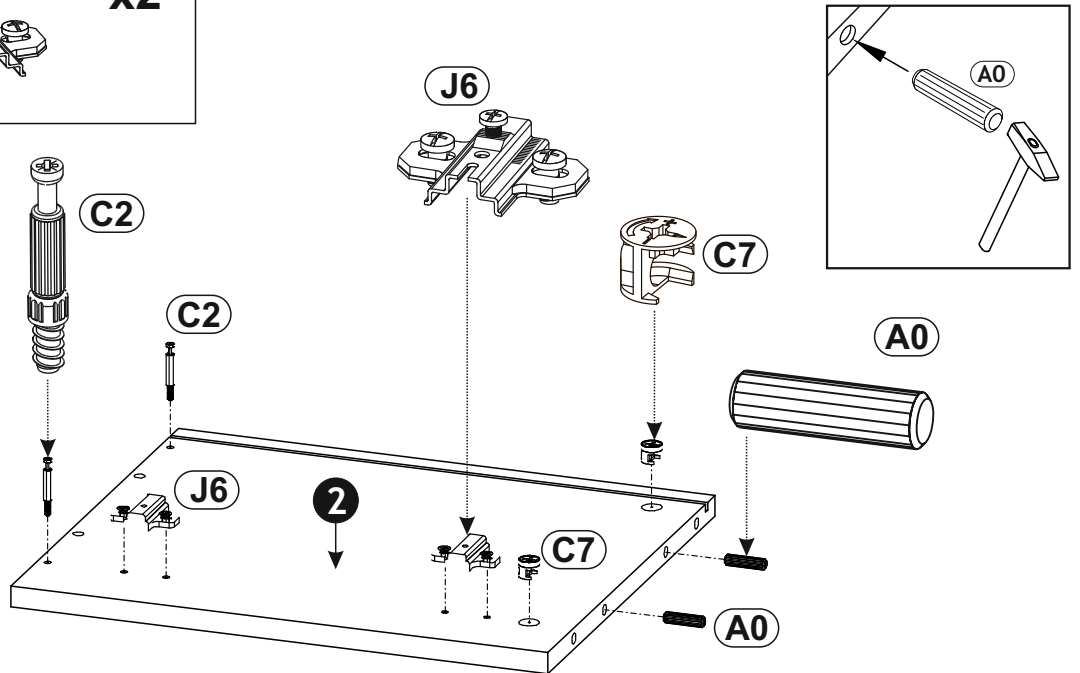
J6		x2						
								



2 ▶

A0	8 x 30mm	x2	C2		x2	C7		x2
						16mm		

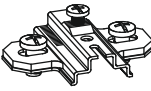
J6		x2						
								

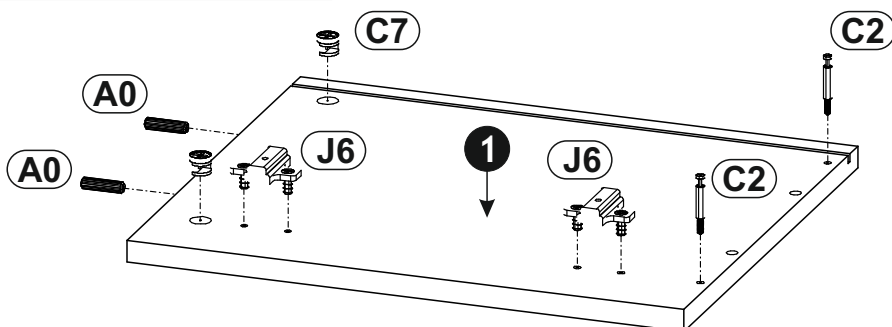

3 ▶

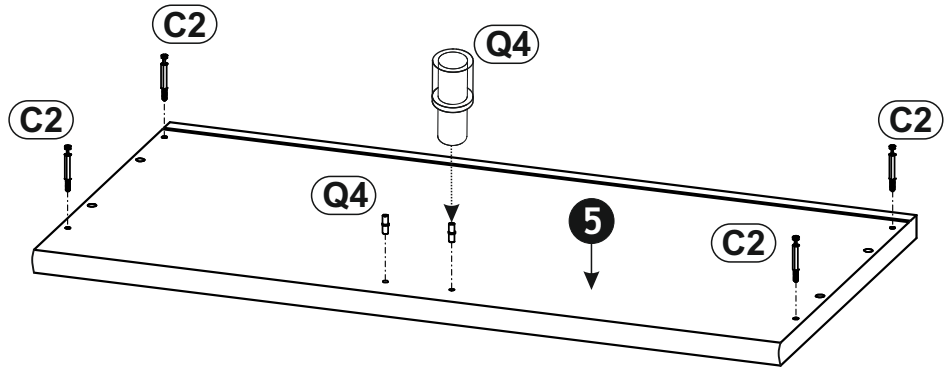
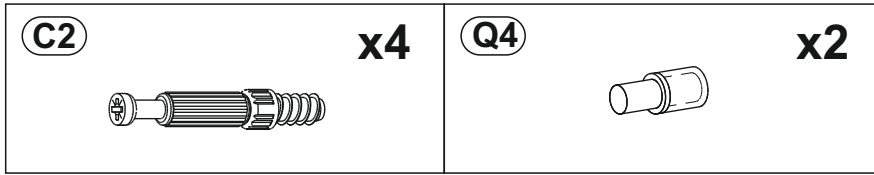

4 ▶

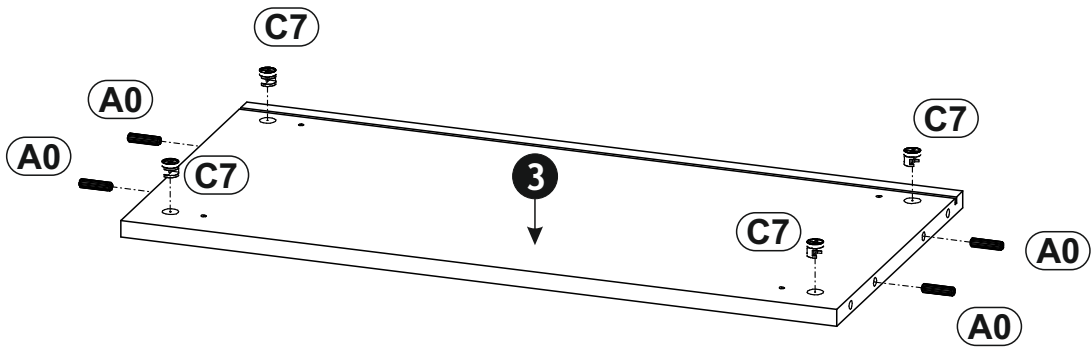
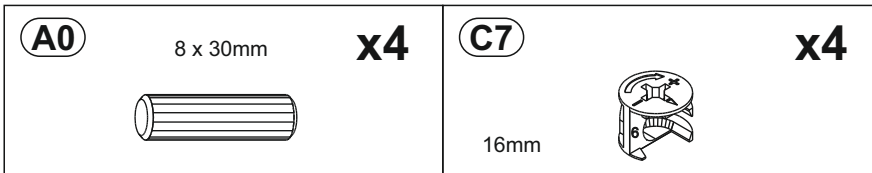

5 ▶

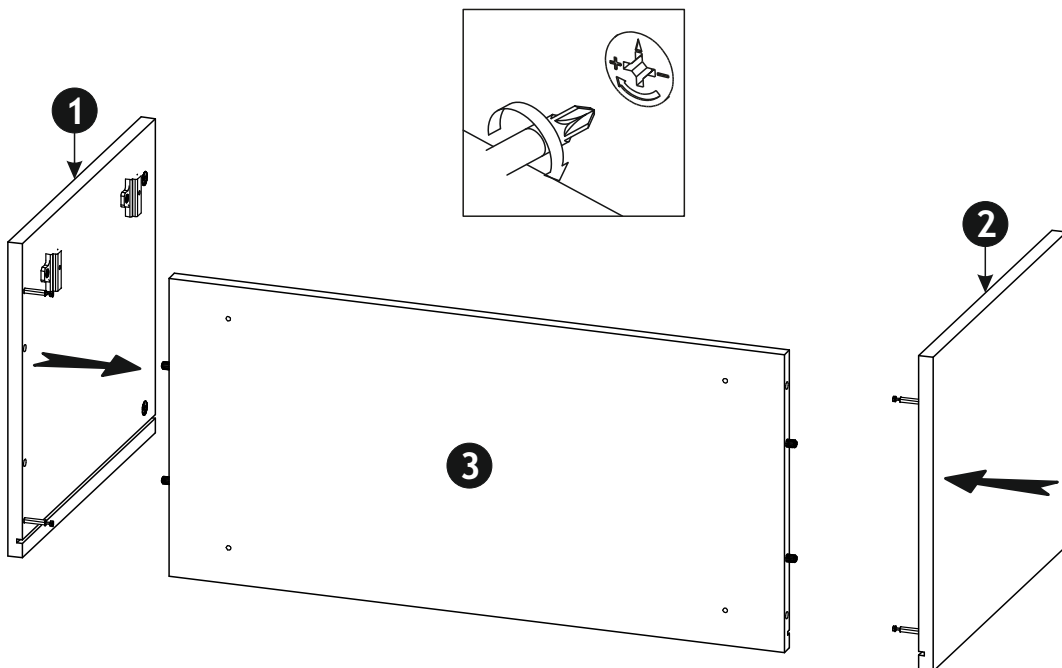

6 ▶

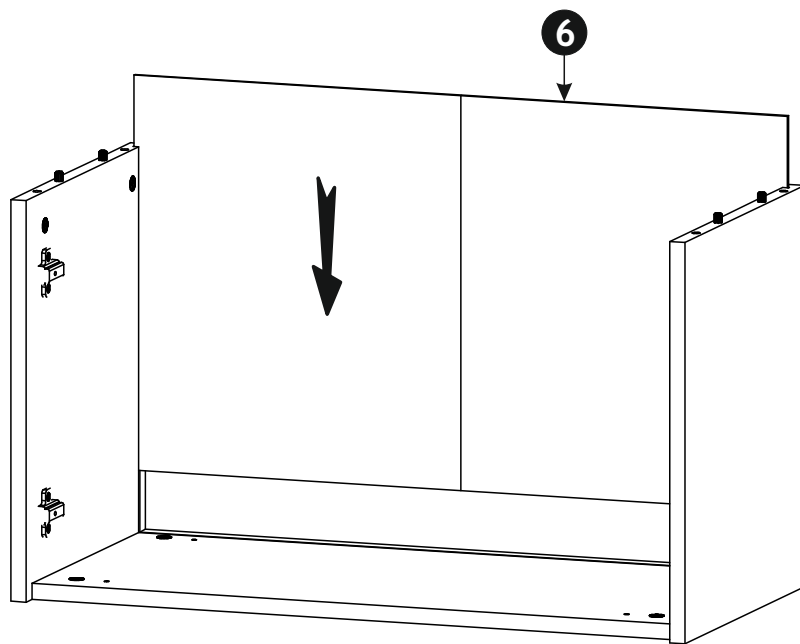

7 ▶

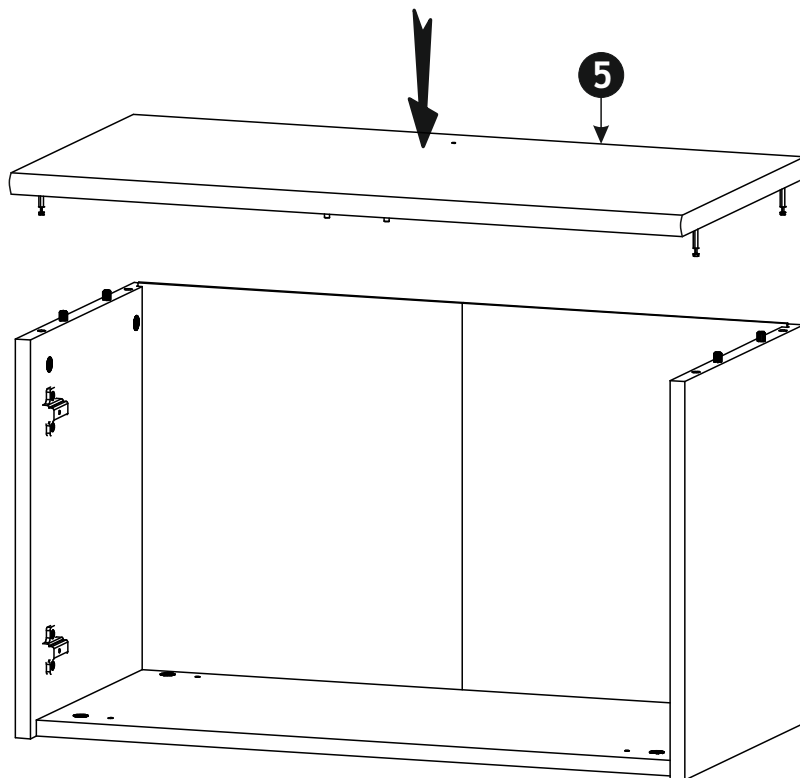

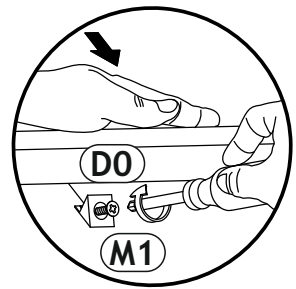
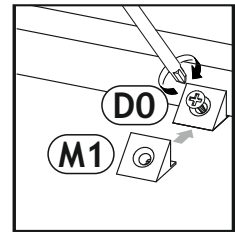
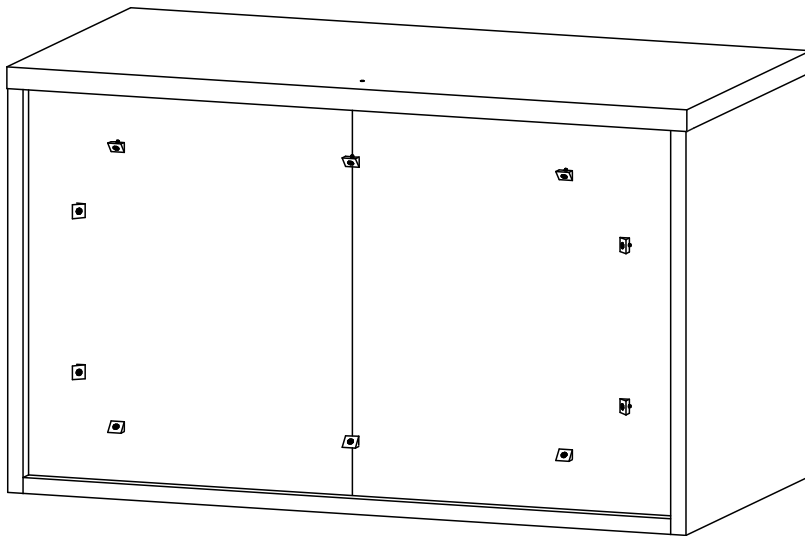
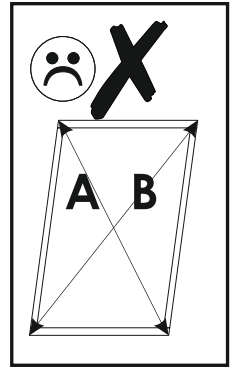
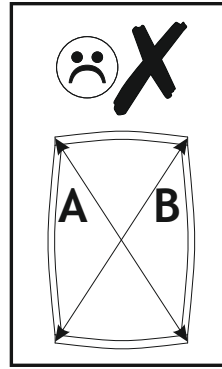
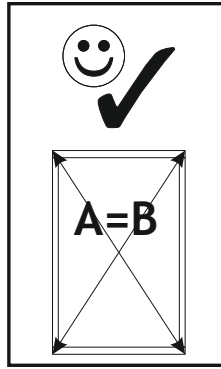

8 ▶

(D0)	3 x 15 mm	x10
(M1)		x10

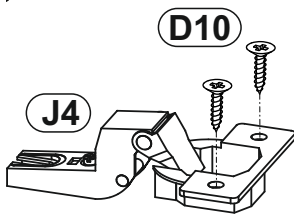

9 ▶



(D10)	4 x 16 mm	x8	(D16)	4,2 x 28 mm	x4
(J4)		x4	(L5)		x2

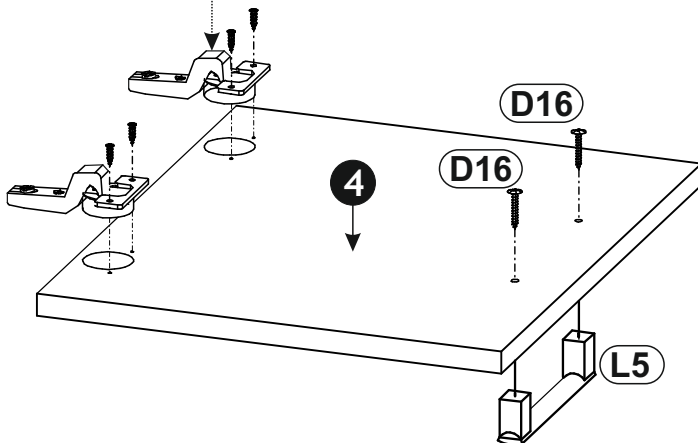

x2

10 ▶

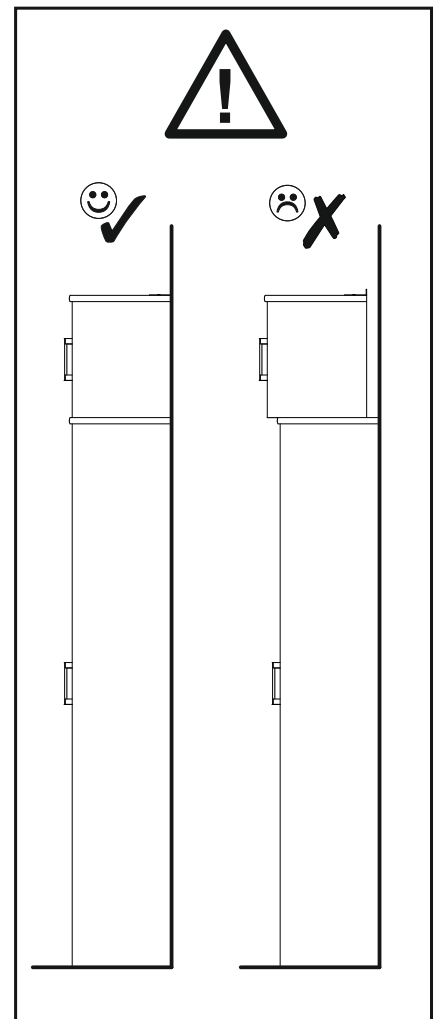
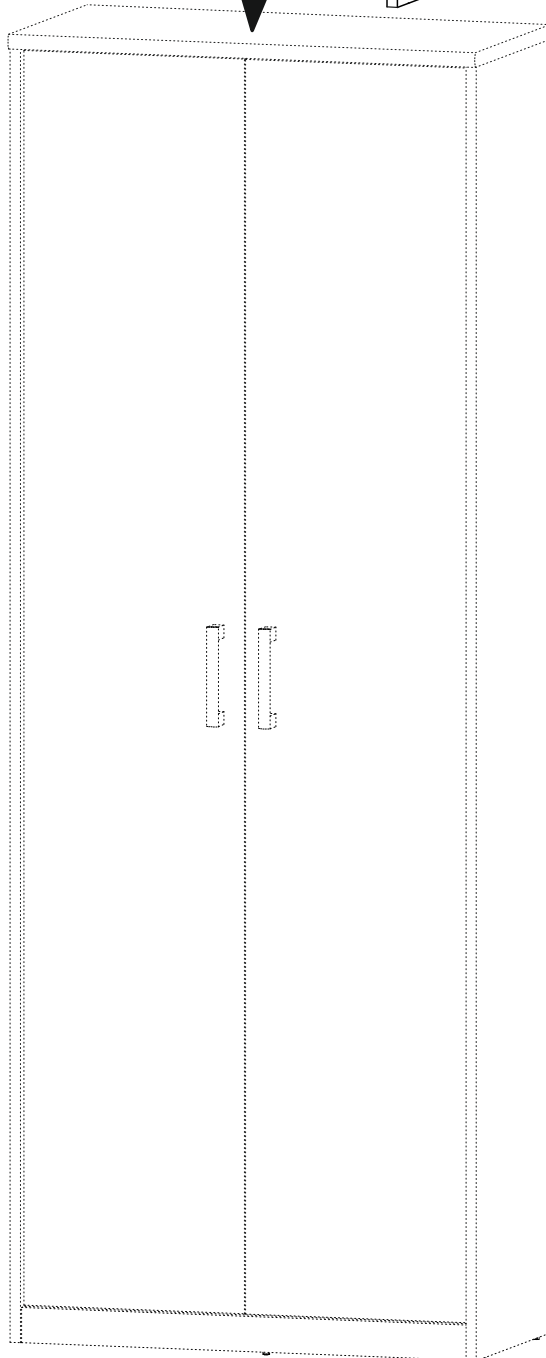
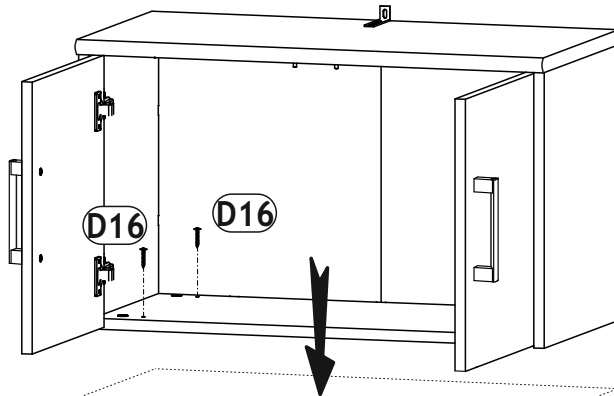
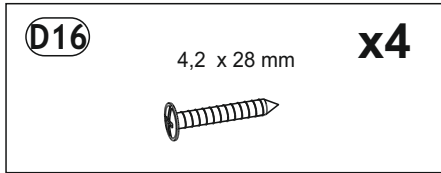

11 ▶

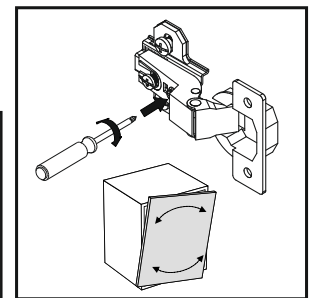
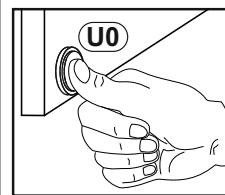
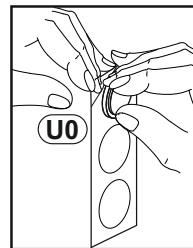
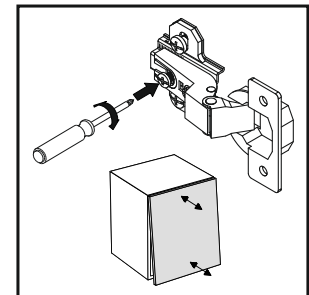
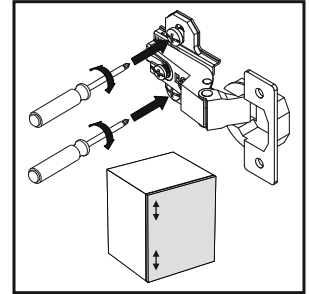
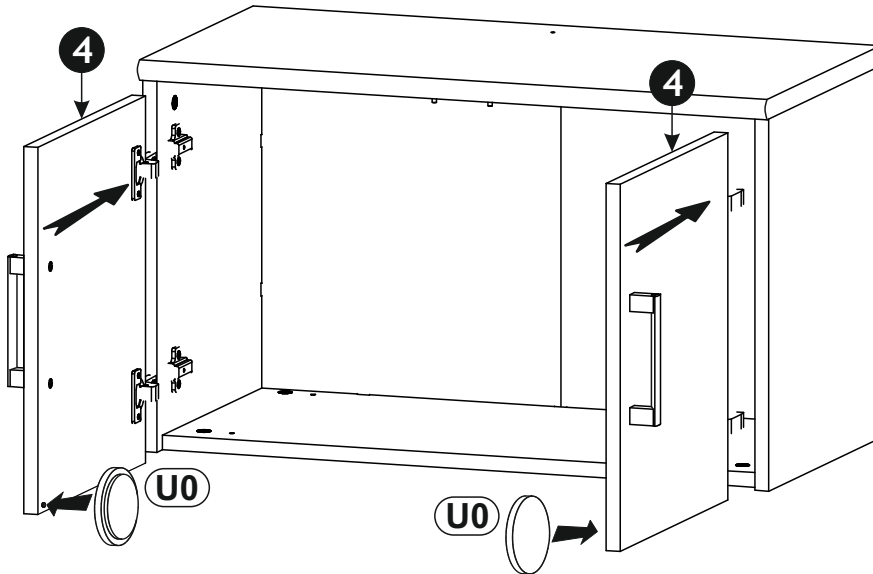
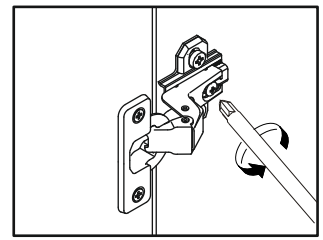
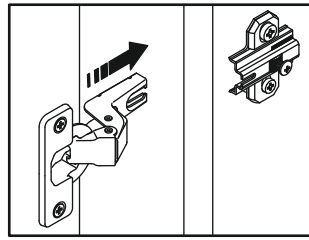
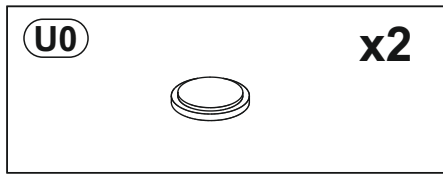

12 ▶

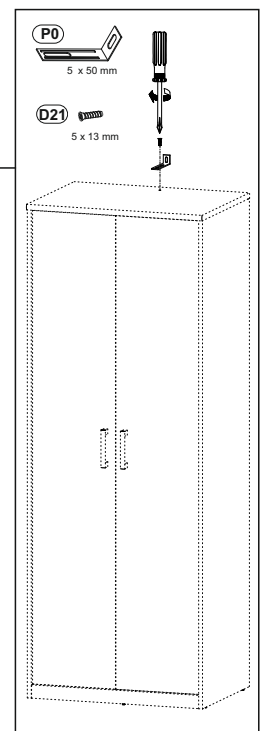
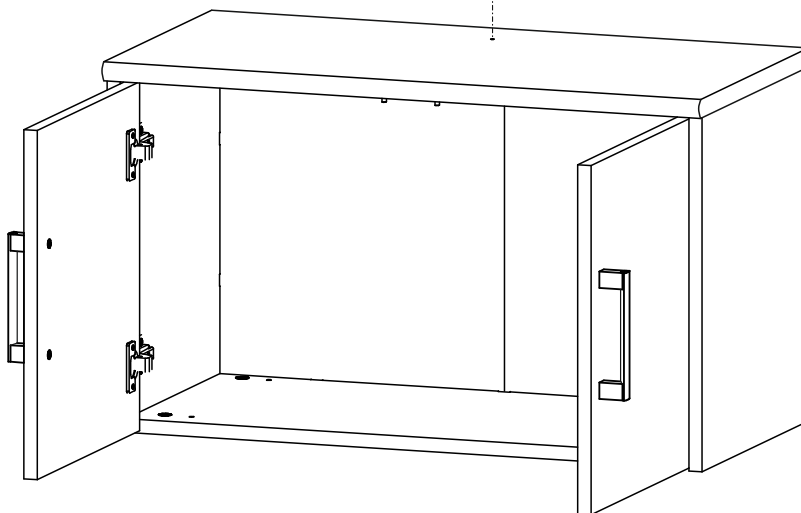
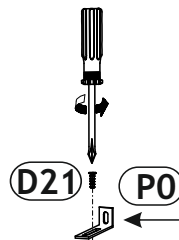

13

E0 5 x 50 mm x1
8 x 50 mm

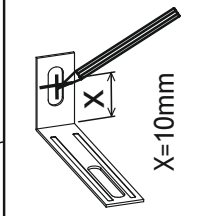
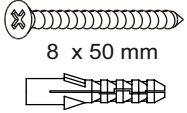

X=10mm

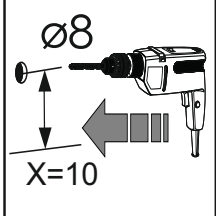

Ø8
X=10

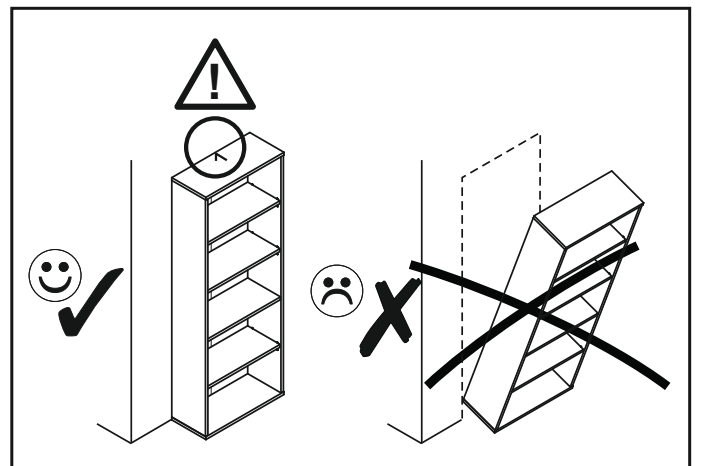
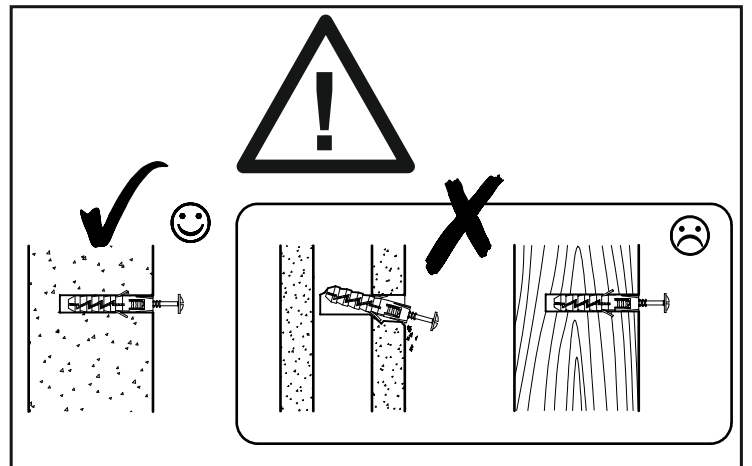
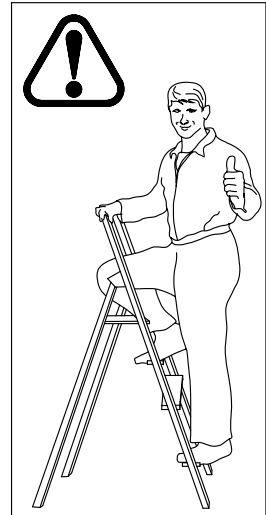
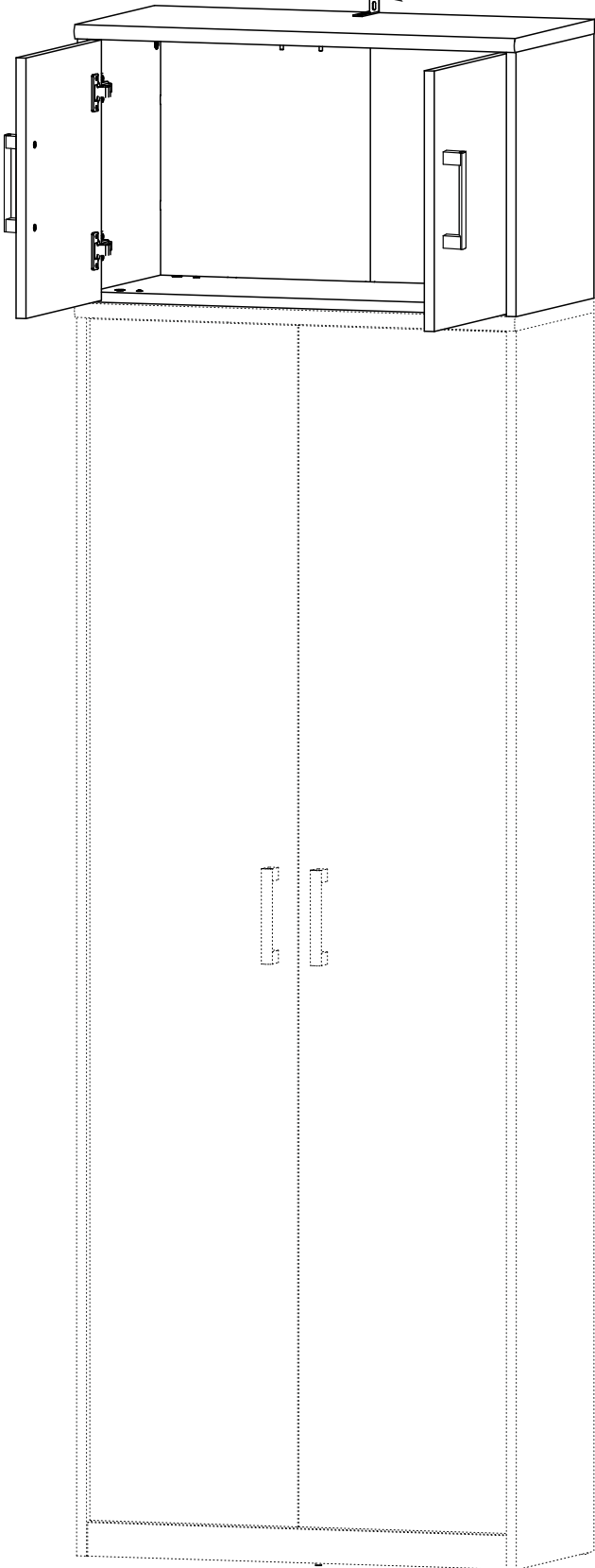
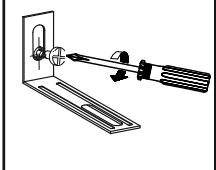
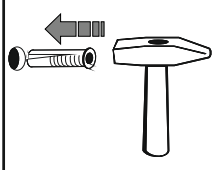

14 ▶

