

VERSION - L

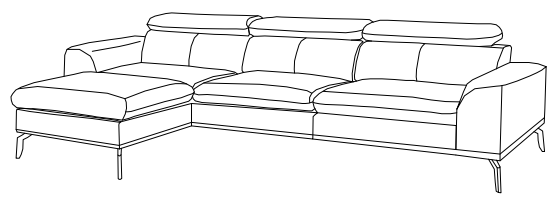

VERSION - R

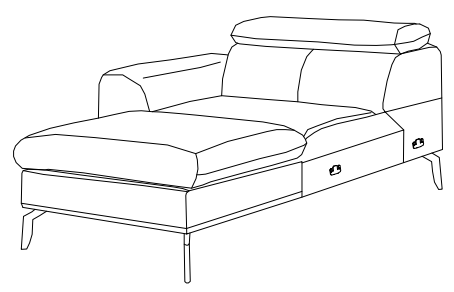
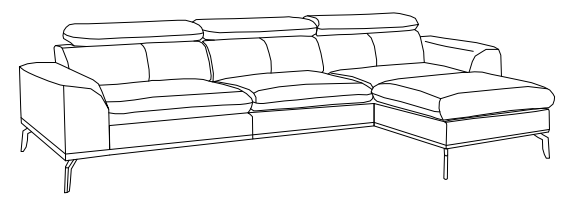

OBL



2 BP

	M6.0x40mm	
A	B	C
6	24	1

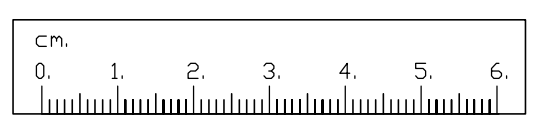

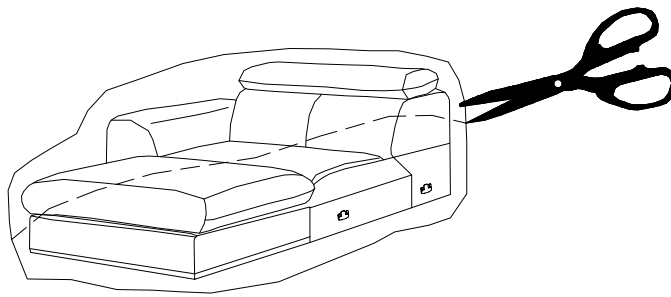

1

OBL



2

	M6.0x40mm		
A		B	C
4		16	1

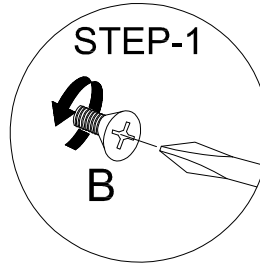
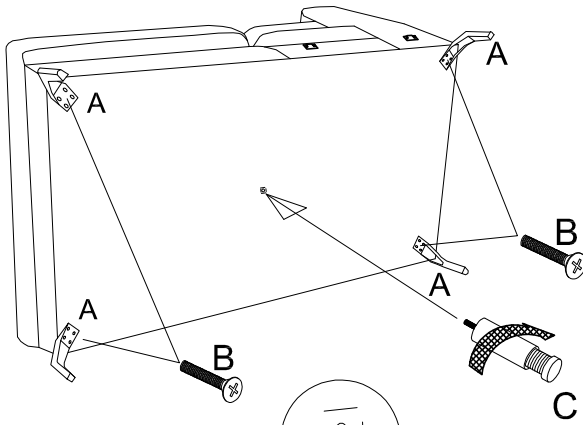
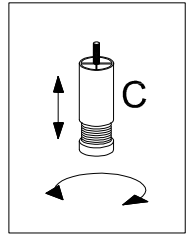
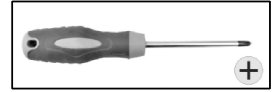

OBL

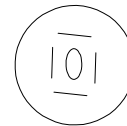
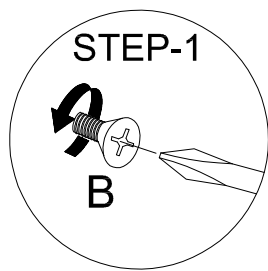
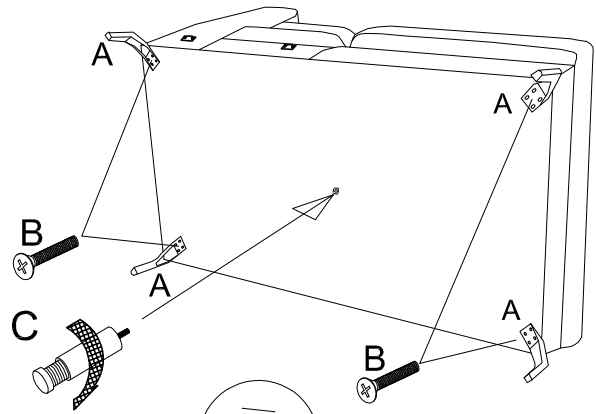
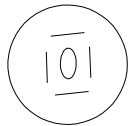

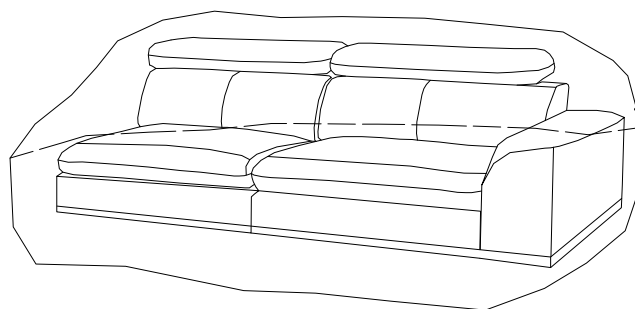

OBP

3

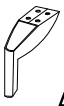

2 BP

4

	M6.0x40mm
A	
2	8

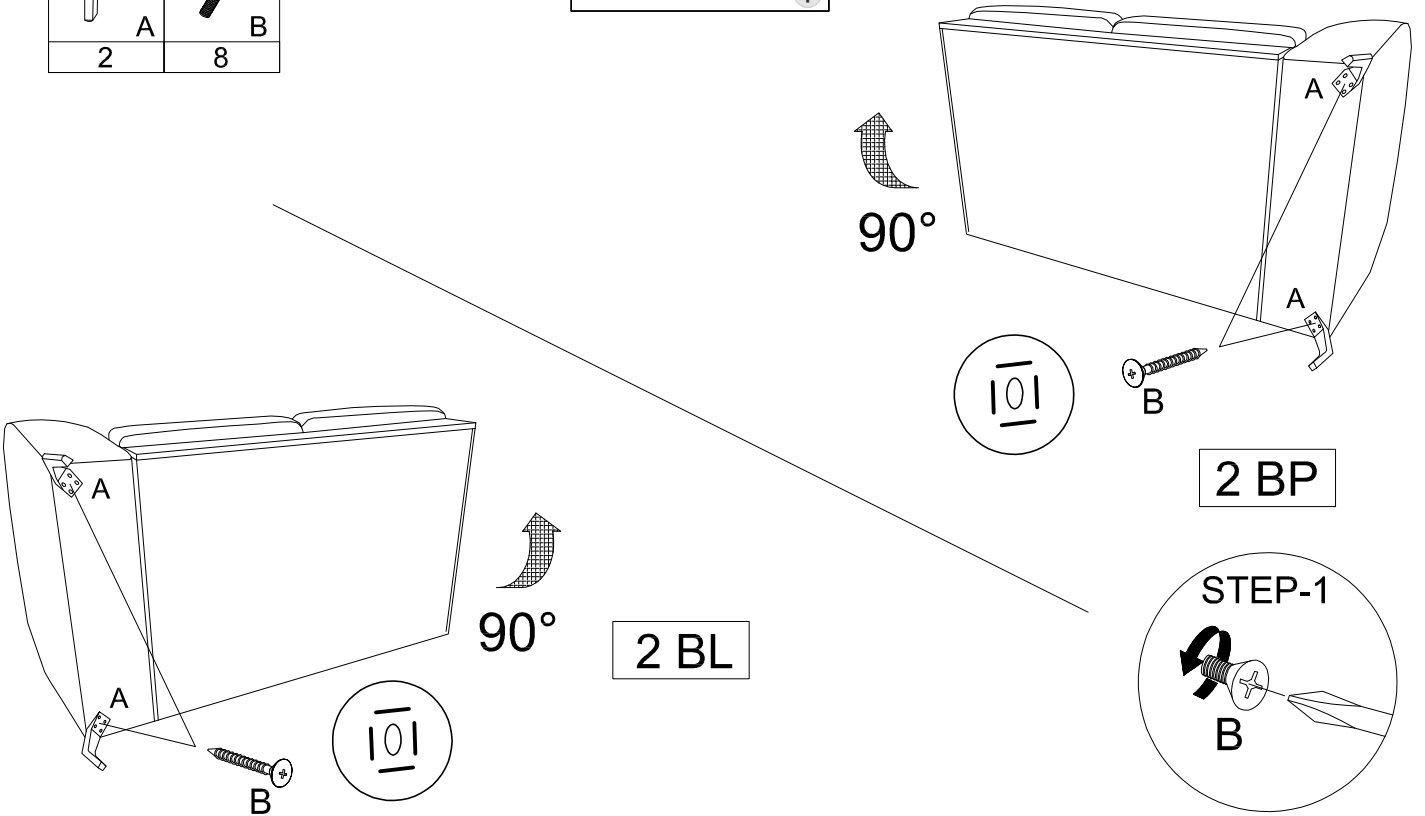
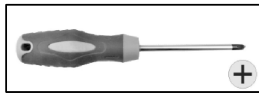

5

