

REDMOND

- | | | | |
|-----------|--|-----------|---|
| D | MONTAGEANLEITUNG
BEDIENUNGSANLEITUNG | GB | ASSEMBLY INSTRUCTIONS
INSTRUCTION MANUAL |
| NL | HANDLEIDING VOOR DE MONTAGE
GEBRUIKSAANWIJZING | PL | INSTRUKCJA MONTAŻU
INSTRUKCJA OBSŁUGI |
| TR | MONTAJ TALIMATI
KULLANIM KLAVUZU | RU | ИНСТРУКЦИЯ ПО МОНТАЖУ
ИНСТРУКЦИЯ ПО ЭКСПЛУАТАЦИИ |
| RO | INSTRUCȚIUNI DE INSTALARE
INSTRUCȚIUNI DE UTILIZARE | IT | ISTRUZIONI DI MONTAGGIO
MANUALE DI ISTRUZIONI |
| FR | NOTICE DE MONTAGE
MANUEL INSTRUCTIONS | SK | MONTÁŽNY NÁVOD
NÁVOD NA POUŽITIE |
| HU | KÖZGYŰLÉS UTASÍTÁSOK
KEZELÉSI UTASÍTÁS | CZ | MONTÁŽNÍ NÁVOD
NÁVOD K POUŽITÍ |
| SI | NAVODILA ZA MONTAŽO
NAVODILA ZA UPORABO | PT | INSTRUÇÕES DE MONTAGEM
MANUAL DO USUÁRIO |
| ES | INSTRUCCIONES DE MONTAJE
MANUAL DEL USUARIO | HR | UPUTE ZA MONTAŽU
UPUTE ZA UPOTREBU |

Service · Dienstverlening · Serwis · Servis · Сервисная служба · Serviciu · Services · Servizio · Servisný list · Szolgáltatás · Servisní list

Name · Naam · Nazwa · İsim · Название · Nume · Nome ·
Názov · Názov · Název · Neve

REDMOND

Typ · Type · Тип · Тип · Tipo · Típus

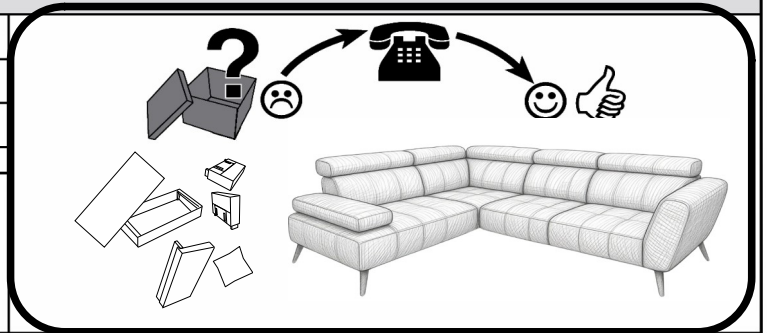
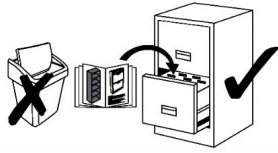









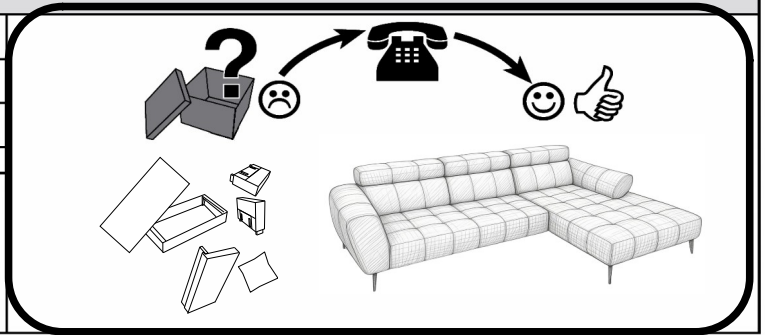
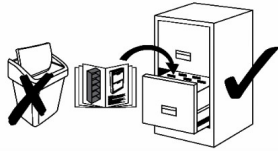

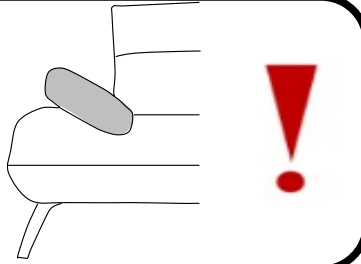
✓			A	B	C	D	E	B
	 2er		/	/	1 x C	1 x D	/	/
	 2er		2 x A	6 x B	1 x C		/	/
	 3er		/	/	2 x C		/	/
	 3er		2 x A	6 x B	2 x C		/	/
	 Abschlussel.		2 x A	8 x B	1 x C		/	/
			1 x A	4 x B	/		3 x E	12 x B

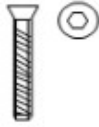
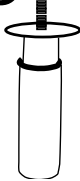
Name · Naam · Nazwa · İsim · Название · Nume · Nome ·
Názov · Názov · Název · Neve

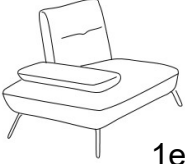
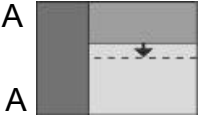
REDMOND

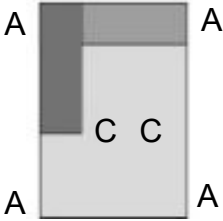
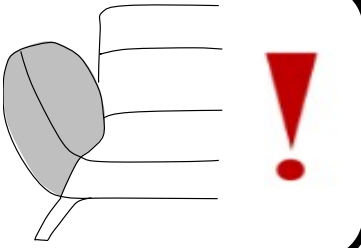
Тур · Type · Tip · Тип · Típo · Típus

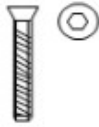
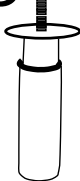

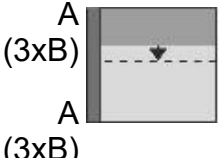
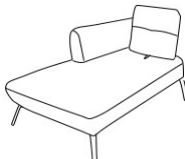
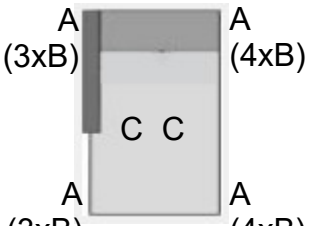
✓	Var. A 	A 	B  M6x25	C 	D  4L
 1er		2 x A	8 x B	/	
		4 x A	16 x B	2 x C	1 x D
✓	Var. B 	A 	B  M6x25	C 	D  4L
 1er		2 x A	6 x B	/	
		4 x A	14 x B	2 x C	1 x D

Service · Dienstverlening · Serwis · Servis · Сервисная служба · Serviciu · Services · Servizio · Servisný list · Szolgáltatás · Servisní list

Name · Naam · Nazwa · İsim · Название · Nume · Nome ·
Názov · Názov · Název · Neve

REDMOND

Тур · Type · Tip · Тип · Típo · Típus

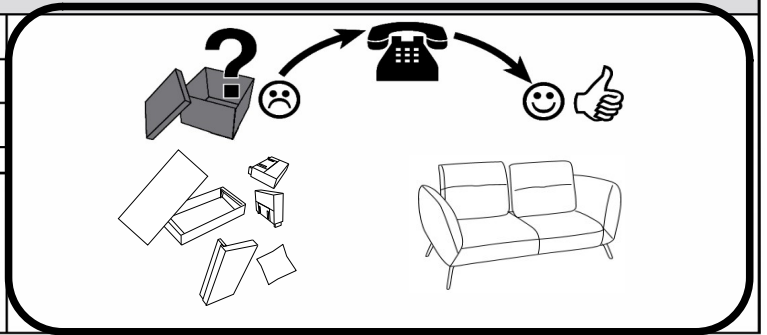
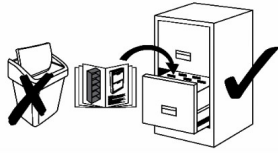

✓		<p>A</p>	<p>B</p> <p>M6x25</p>	<p>C</p>	<p>D</p> <p>4L</p>
		<p>4 x A</p>	<p>16 x B</p>	<p>/</p>	
	<p>LOVESEAT</p>	<p>4 x A</p>	<p>12 x B</p>	<p>2 x C</p>	<p>1 x D</p>
	<p>MEGASOFA</p>	<p>4 x A</p>	<p>12 x B</p>	<p>2 x C</p>	

1

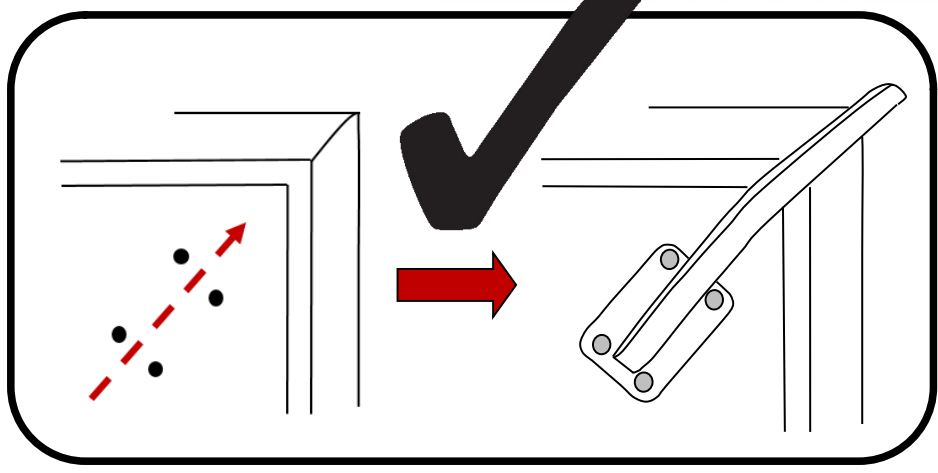
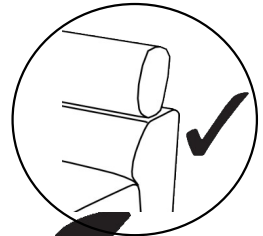
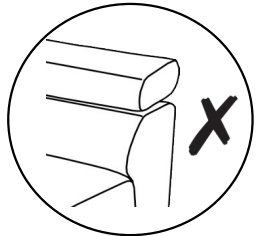
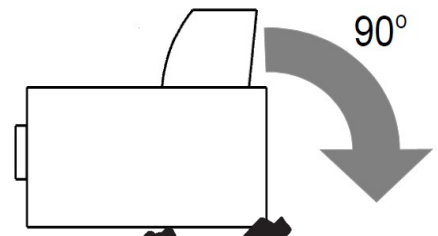

2

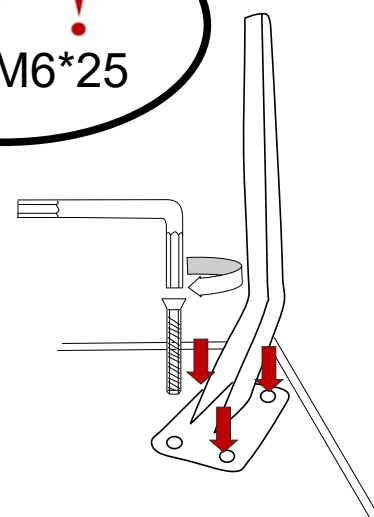
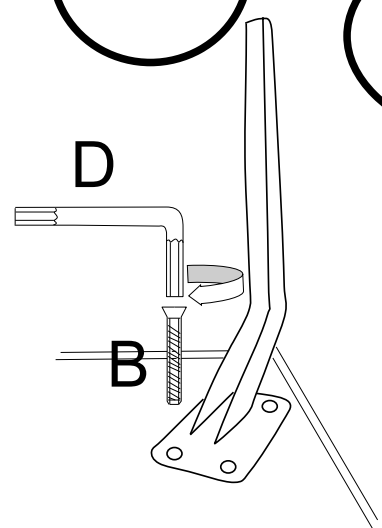
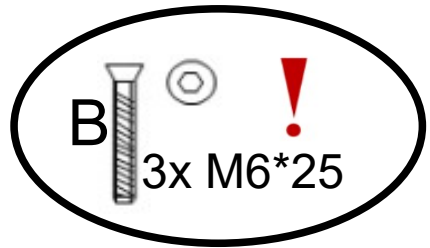
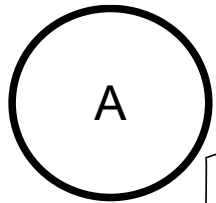
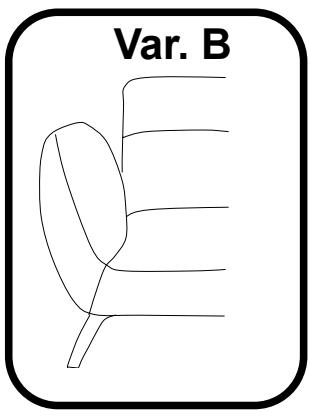
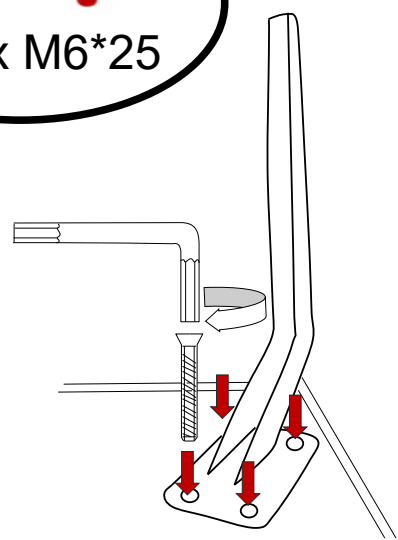
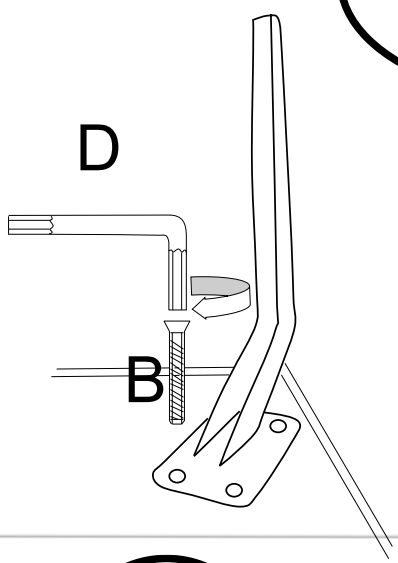
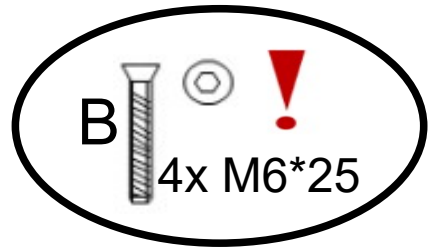
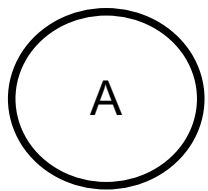
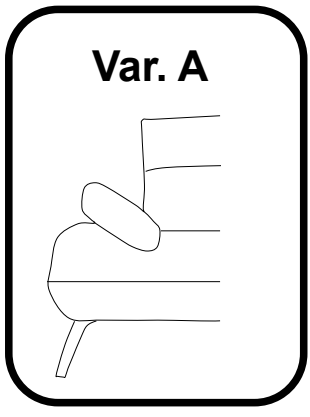

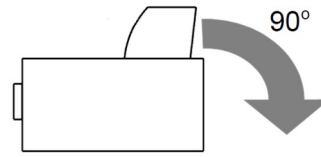
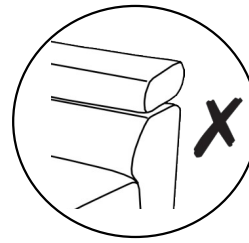
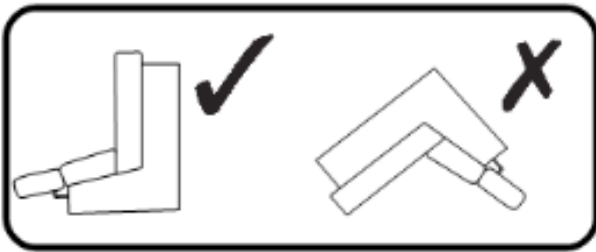

STÜTZFÜßE sind regulierbar !
Es muss unbedingt darauf geachtet werden, dass die Stützfüße auf die Höhe der Originalfüße angepasst werden!

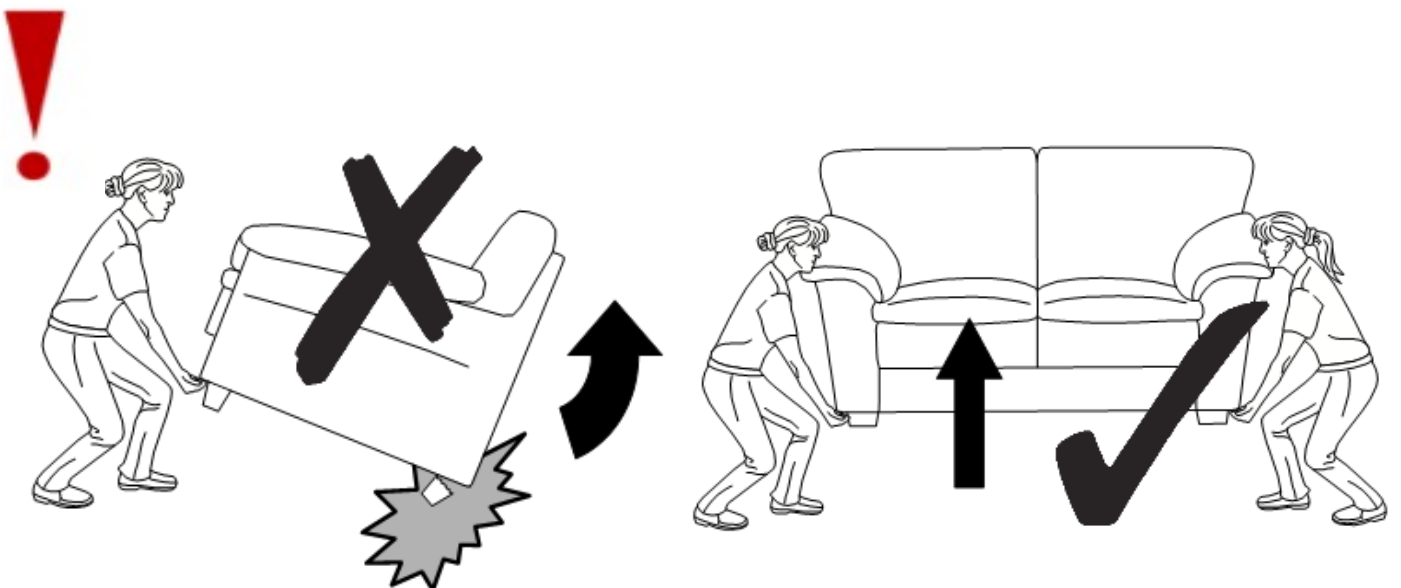
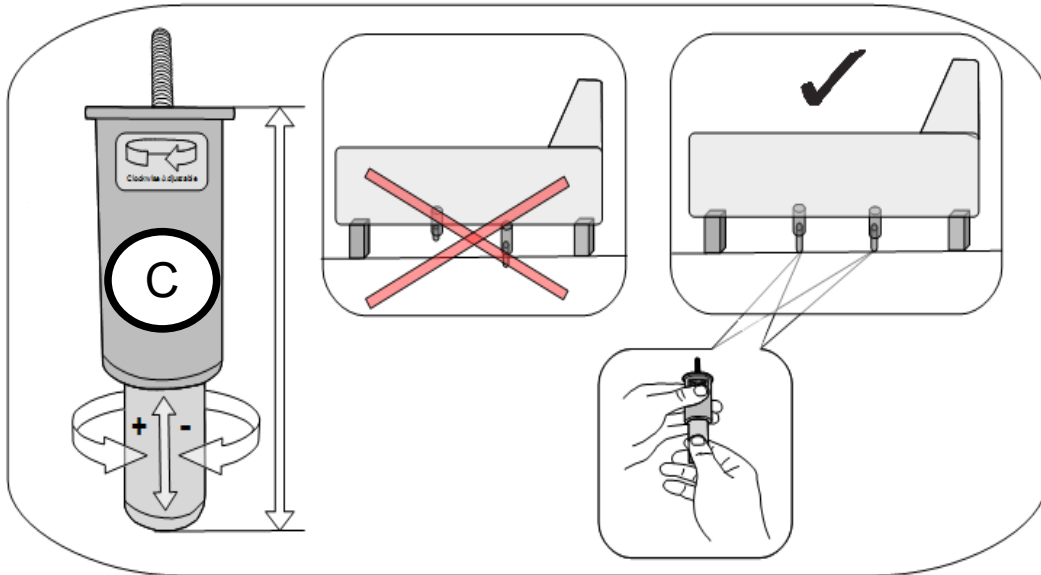

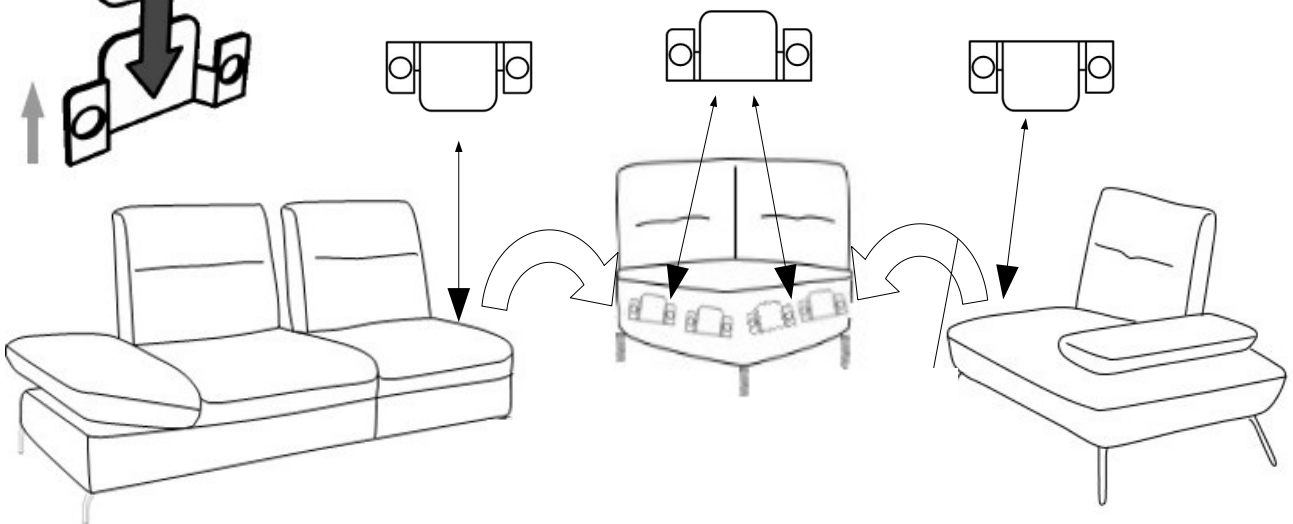
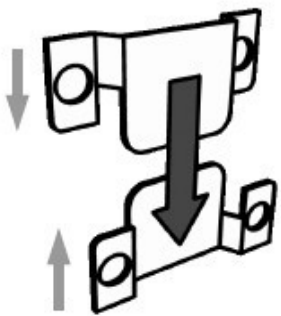
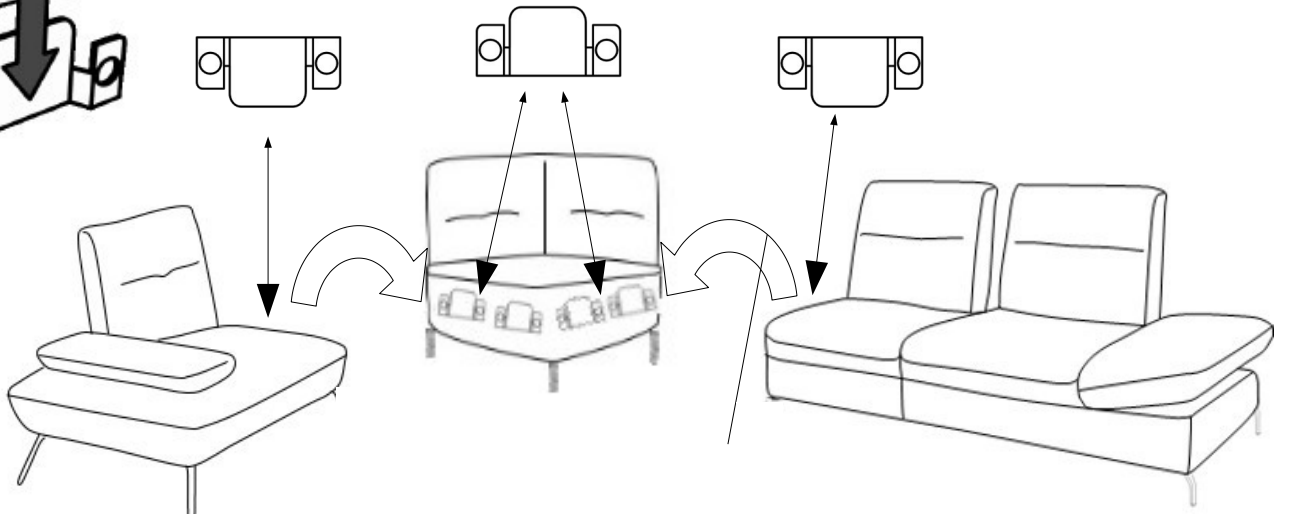
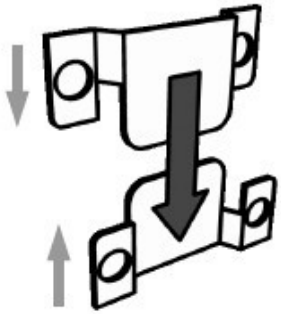

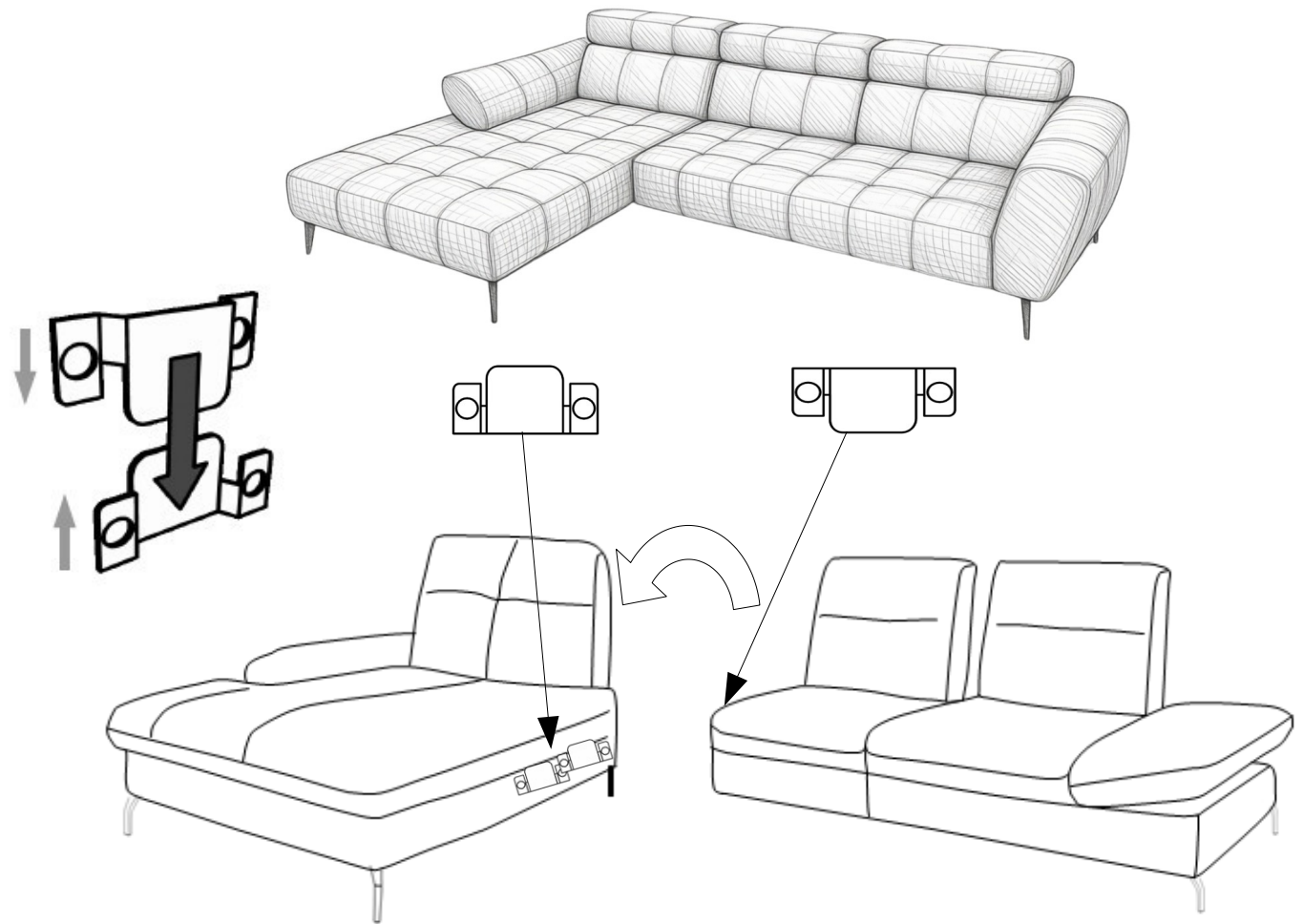
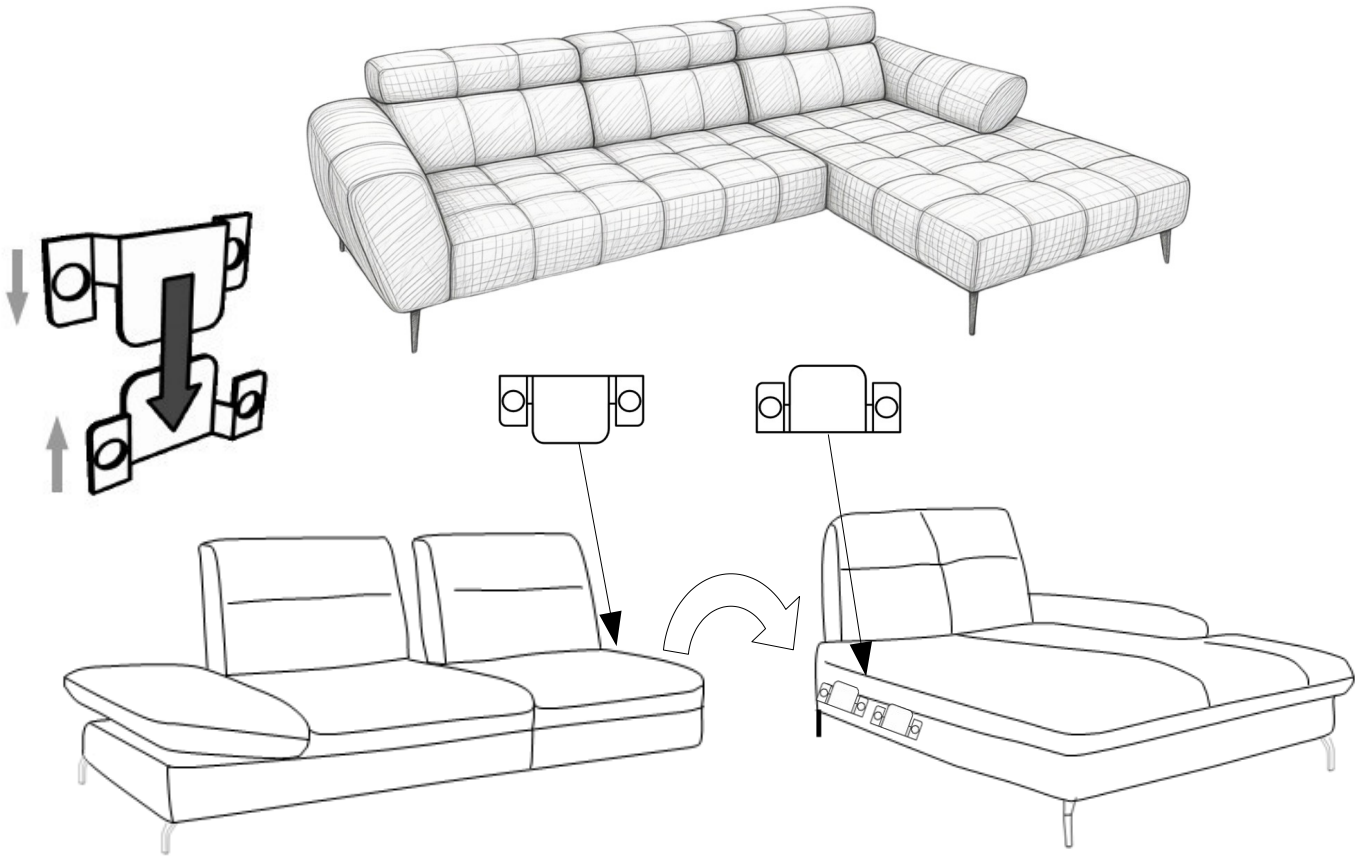

Montageanleitung der Rücken mit dem Click&Seat Beschlag -
1-Sitzer oder Abschlusselement mit Schwenkrücken (1/2)

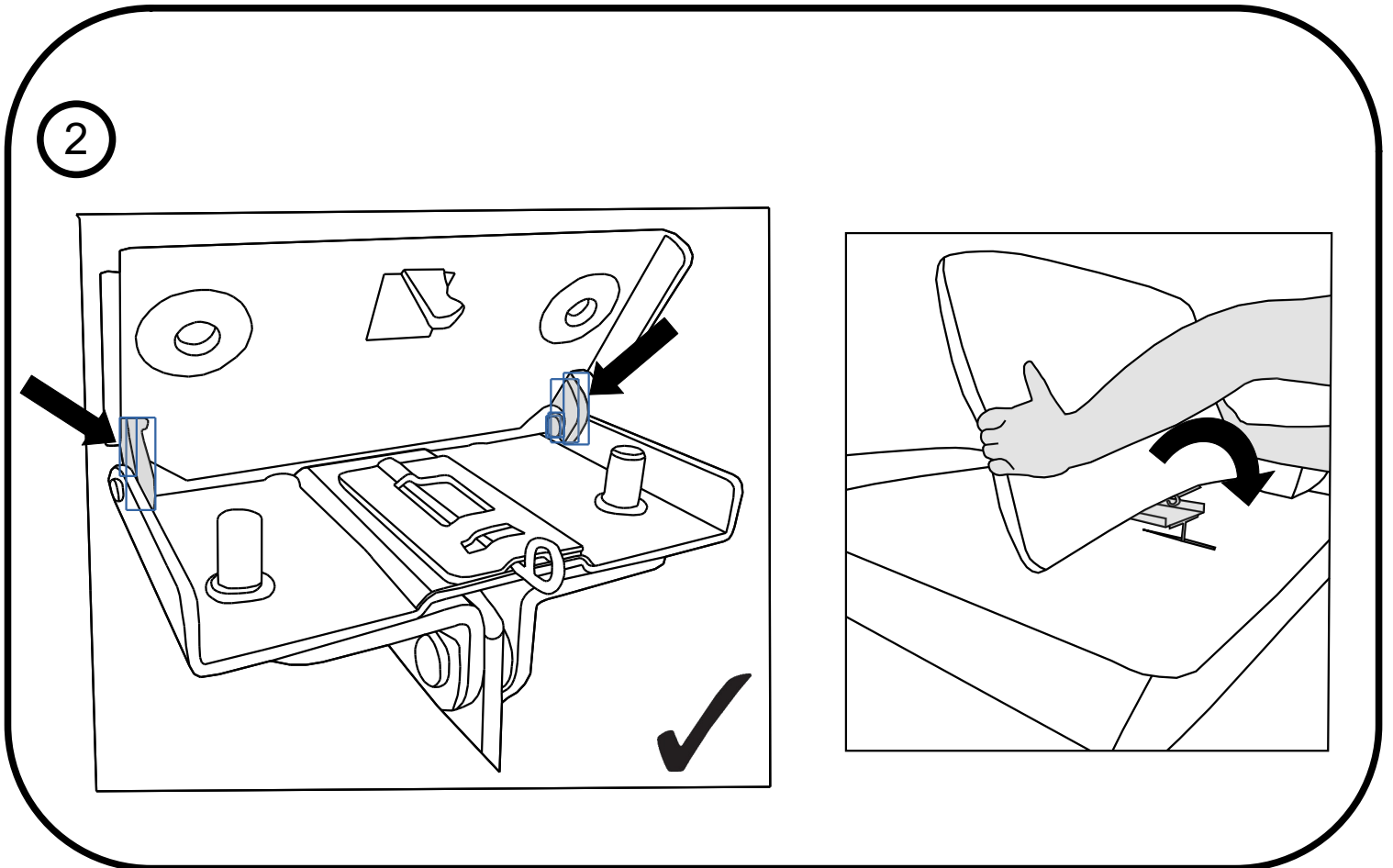
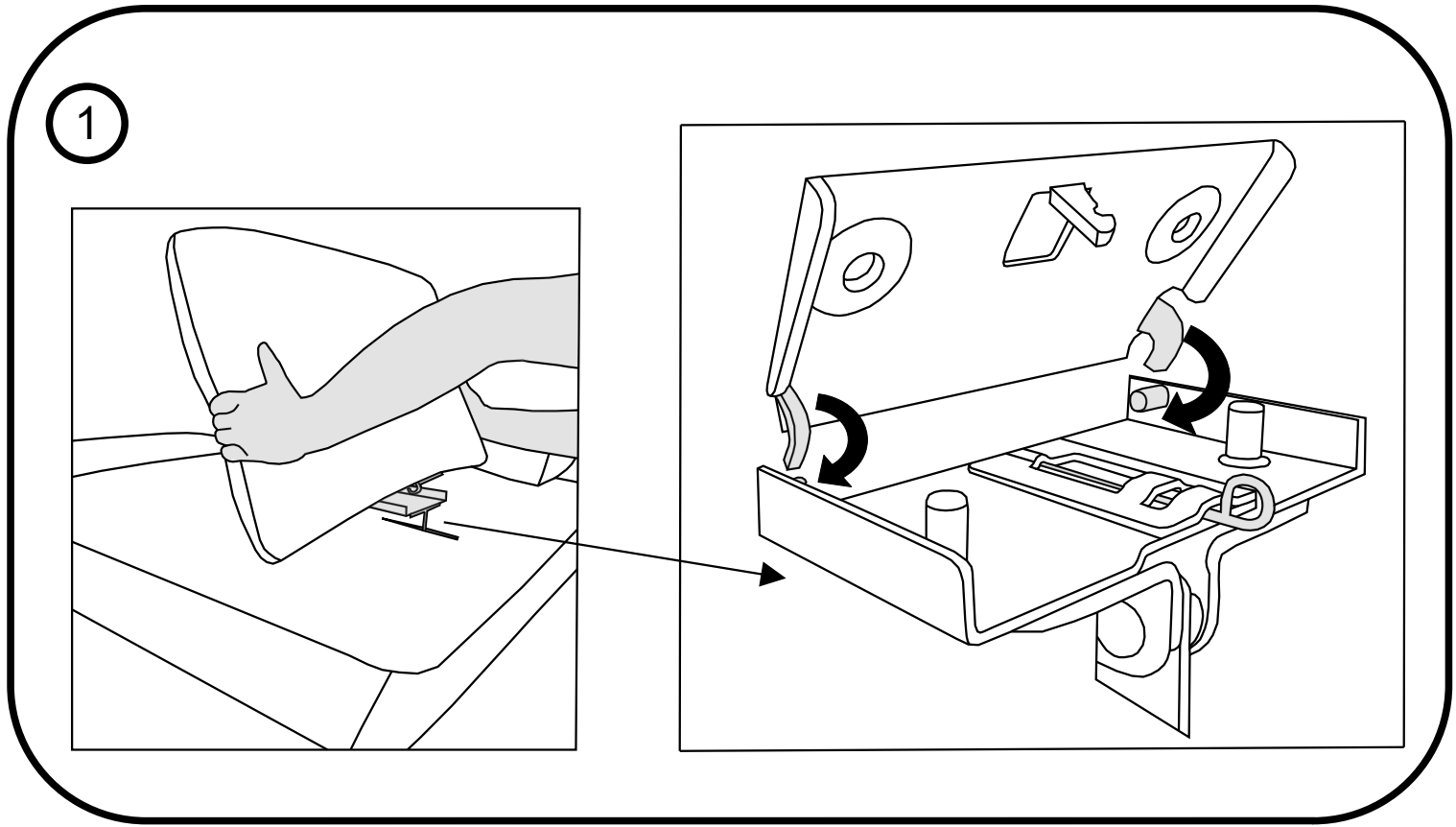

Montageanleitung der Rücken mit dem Click&Seat Beschlag -
1-Sitzer oder Abschlusselement mit Schwenkrücken (2/2)

3

