



Farbtemperatur anpassen

Bewegen Sie Ihre Hand vor der Leuchte, um diese ein- oder auszuschalten und die Farbtemperatur anzupassen.



Helligkeit anpassen

Halten Sie Ihre Hand vor die Leuchte, um die Helligkeit stufenlos anzupassen.

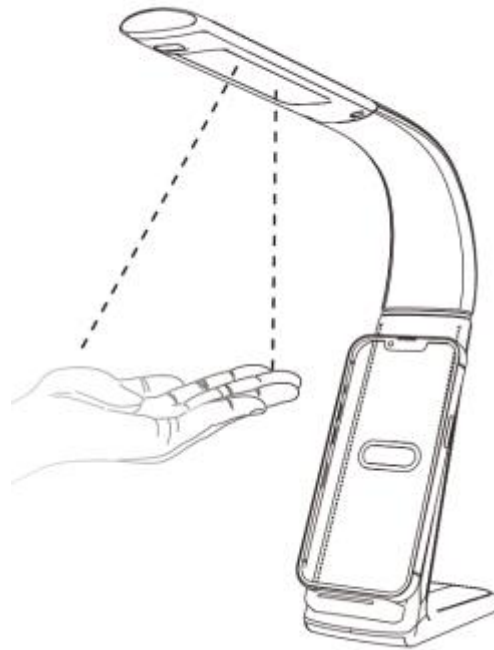
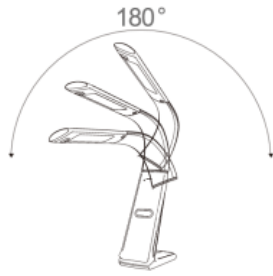

Flächenlichtquelle

flexibler Leuchtenarm

kabelloses Laden

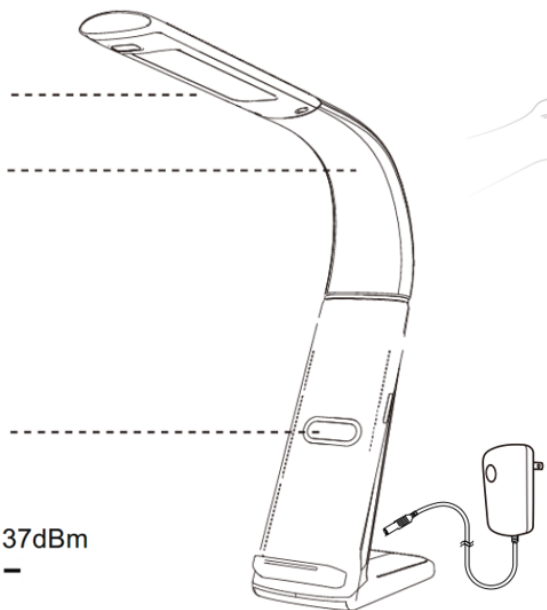

110 - 205KHz 37dBm



kabelloses Schnellladen (10 W)



Adaptor for small phones

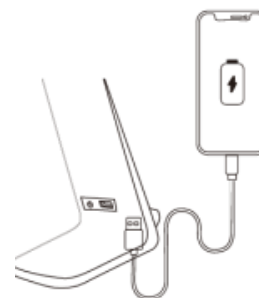

Laden über USB (2,1 A)

DE: Dieses Produkt enthält eine Lichtquelle der Energieeffizienzklasse E.

Austausch des Betriebsgeräts durch den Endkunden.

LED-Lichtquelle nicht austauschbar

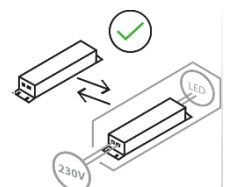

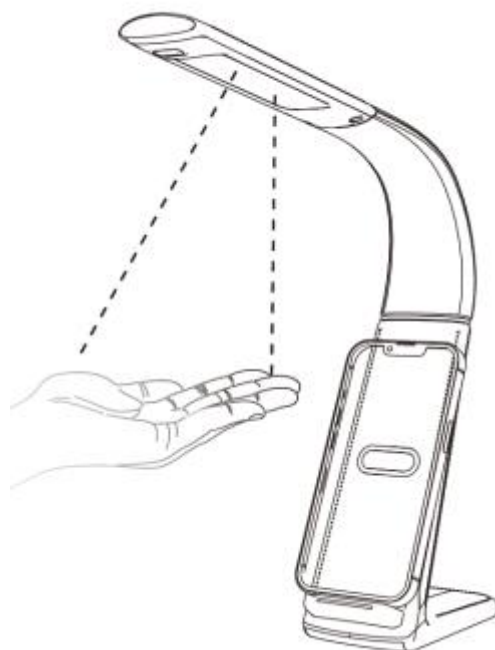
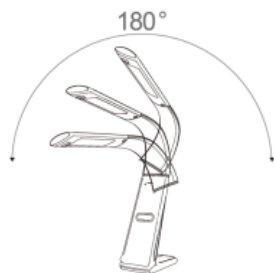

Nastavení barevné teploty

Pohybem ruky před svítidlem jej můžete zapnout nebo vypnout a nastavit barevnou teplotu.



Nastavení jasu

Pro plynulé nastavení jasu držte ruku před svítidlem.

plošná žárovka

flexibilní rameno svítidla

bezdrátové nabíjení

110 - 205KHz 37dBm

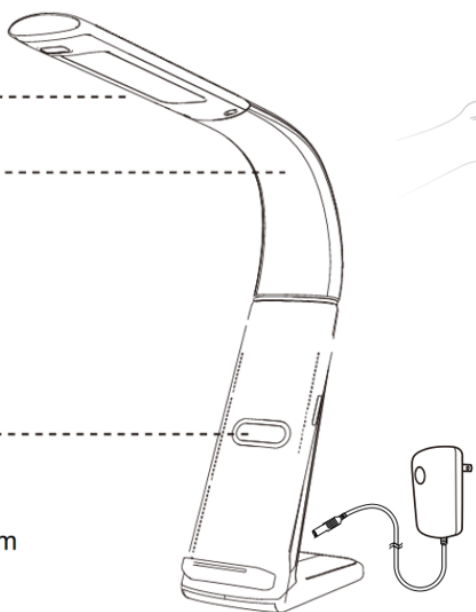

bezdrátové rychlé nabíjení (10 W)



Adaptor for small phones

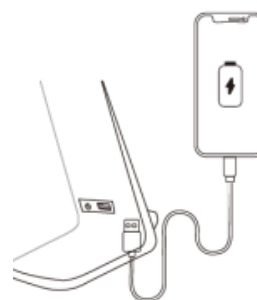

nabíjení pomocí USB (2,1 A)

CZ: Tento výrobek obsahuje žárovku třídy energetické účinnosti E.

Výměna provozního zařízení koncovým zákazníkem.

LED žárovku nelze vyměnit.

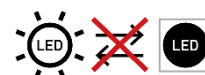
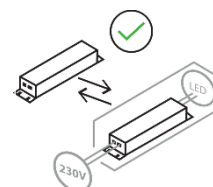

1 X LED 7W + 1 X Wireless Charging 10W
AC 220-240V ~50/60Hz

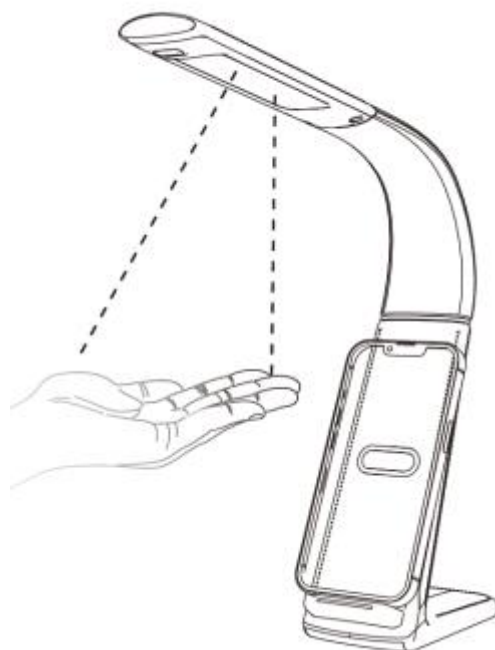
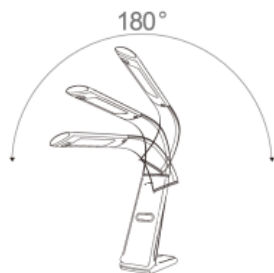

**Justera färgtemperatur**

Rör med handen framför lampen för att tända och släcka lampen samt för att justera färgtemperaturen.

**Justera ljusstyrkan**

Håll handen framför lampen för att steglöst justera ljusstyrkan.

Ytljuskälla

Flexibel lamparm

Kabelfri laddning

110 - 205KHz 37dBm

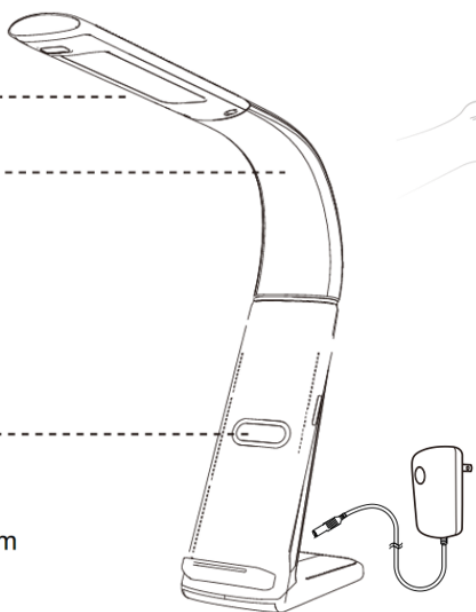

Kabelfri
snabbladdning
(10 W)



Adaptor for
small phones

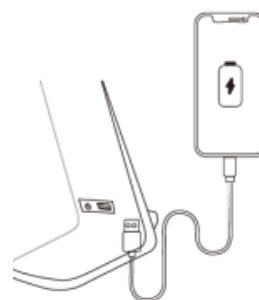

Ladda via
USB (2,1 A)

SE: Denna produkt innehåller en ljuskälla med energiklass E.

Apparaten byts ut av kunden.

Ljuskällan är inte utbytbar.

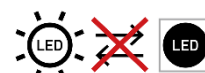
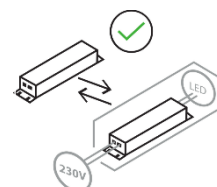

1 X LED 7W + 1 X Wireless Charging 10W
AC 220-240V ~50/60Hz



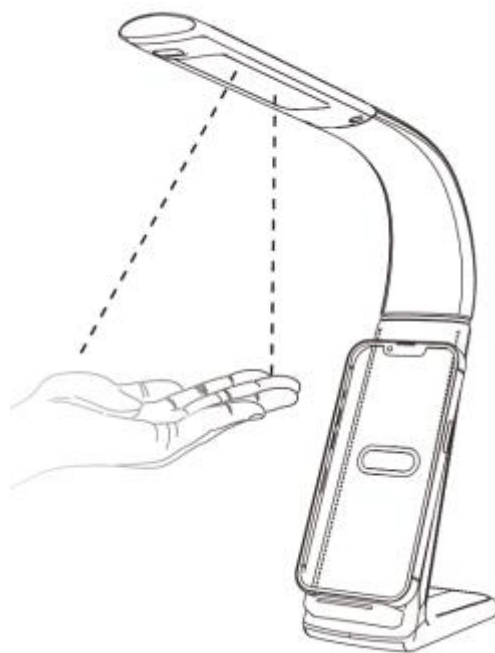
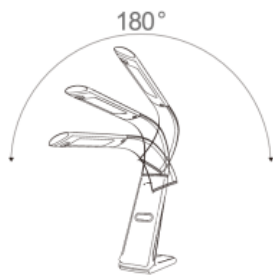

Nastavenie farebnej teploty

Pohybovaním rukou pred lampou zapnete alebo vypnete svetlo, prípadne nastavíte farebnú teplotu.



Nastavenie jasu

Podržaním ruky pred lampou nastavíte plynule jas.

plošný svetelný zdroj

flexibilné rameno lampy

bezdrôtové nabíjanie

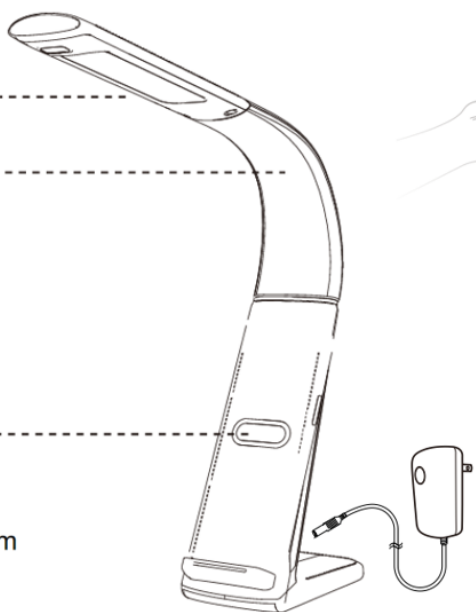

110 - 205KHz 37dBm
+ -



rýchle bezdrôtové nabíjanie (10 W)



Adaptor for small phones

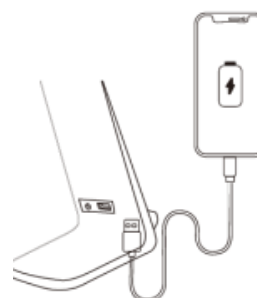

nabíjanie prostredníctvom USB vstupu (2,1 A)

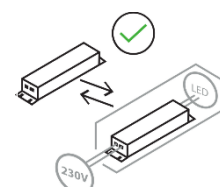

SK: Tento výrobok obsahuje svetelný zdroj triedy energetickej účinnosti E.

Napájací zdroj smie vymeniť konečný zákazník.

LED svetelný zdroj nie je možné vymeniť.



1 X LED 7W + 1 X Wireless Charging 10W
AC 220-240V ~50/60Hz



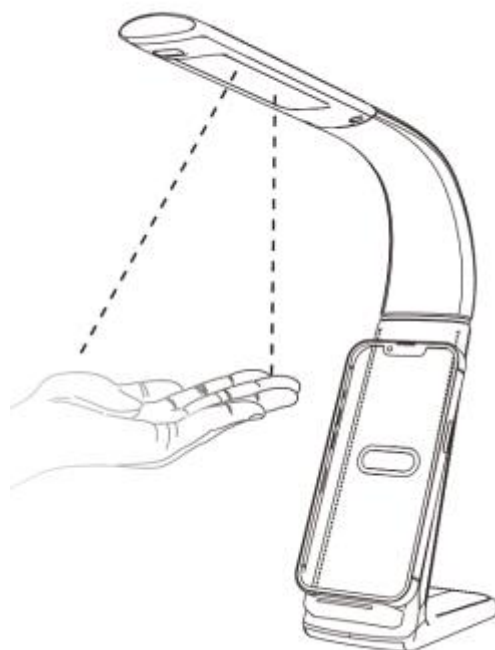
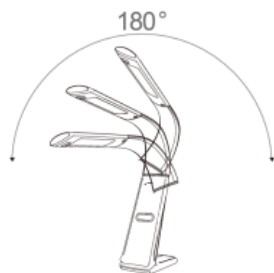

Prilaganje barvne temperature

Pomaknite svojo roko pred svetilko, če jo želite vklopiti ali izklopiti ter če želite prilagoditi barvno temperaturo.



Prilaganje svetlosti

Podržite svojo roko pred svetilko, če želite brezstopenjsko nastaviti svetlost.

Ploskovni svetlobni vir

Fleksibilen zgib svetilke

Brezžično polnjenje

110 - 205KHz 37dBm

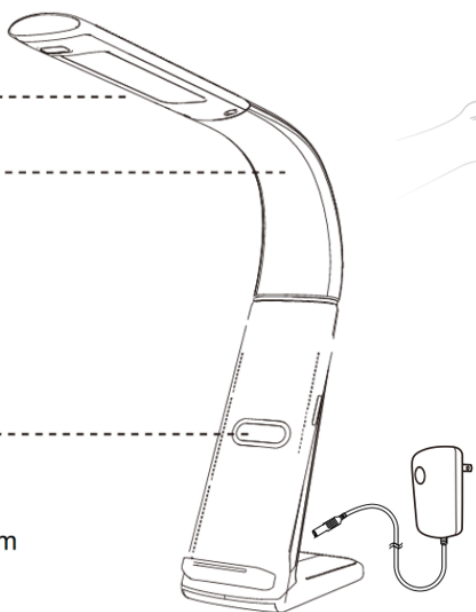

Hitro brezžično polnjenje (10 W)



Adaptor for small phones

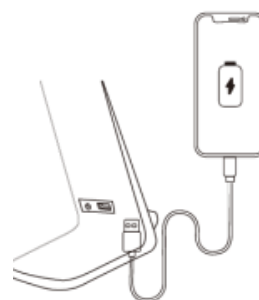

Polnjenje prek USB (2,1 A)

SI: Ta izdelek vsebuje svetlobni vir razreda energijske učinkovitosti E.

Zamenjava krmilne naprave s strani končnega kupca.

LED-svetlobnega vira ni mogoče zamenjati.

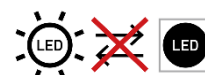
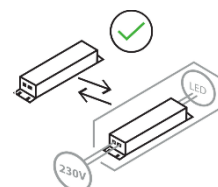

1 X LED 7W + 1 X Wireless Charging 10W
AC 220-240V ~50/60Hz



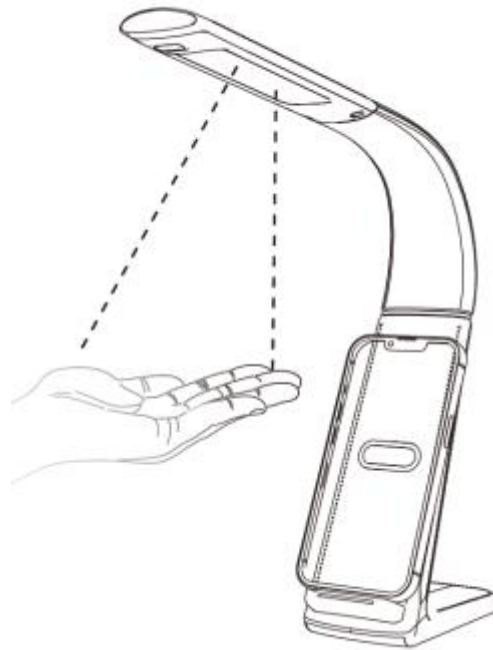
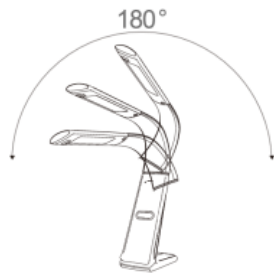

Színhőmérséklet beállítása

A lámpa be-/kikapcsolásához,
ill. a színhőmérséklet
beállításához mozgassa a kezét
a lámpa alatt.



Fényerő beállítása

Tartsa a kezét a lámpa alá a
fényerő fokozatmentes
beállításához.

izzó

rugalmas lámpakar

vezeték nélküli töltés

110 - 205KHz 37dBm

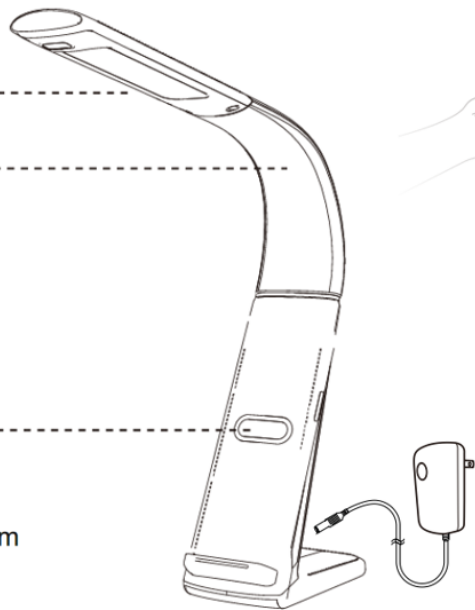

vezeték nélküli
gyorstöltés (10 W)

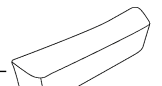

Adaptor for
small phones

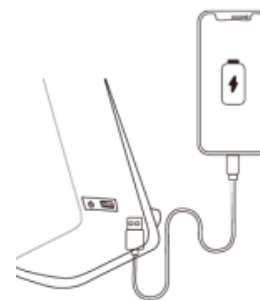

töltés USB-ről
(2,1 A)

HU: A termék az E energiasztályba tartozó fényforrást tartalmaz.

Működtető eszköz cseréje felhasználó által.

A LED izzó nem cserélhető.

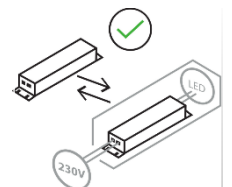

1 X LED 7W + 1 X Wireless Charging 10W
AC 220-240V ~50/60Hz



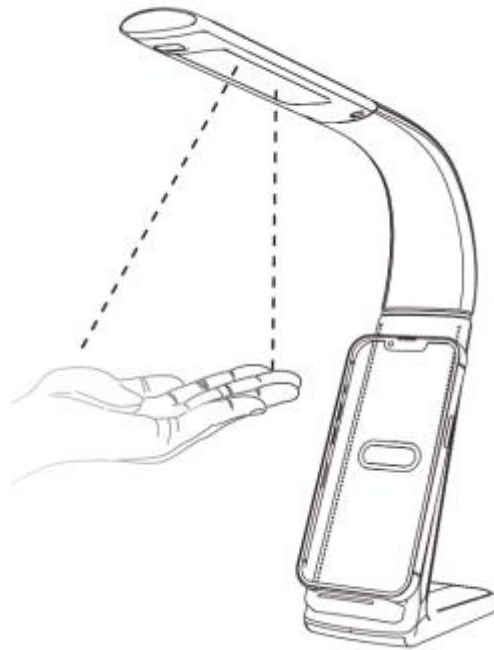
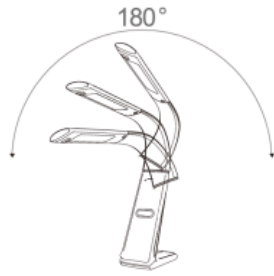

Podešavanje temperature boje

Pomičite ruku ispred ispred svjetiljke kako biste ju uključili ili isključili te prilagodili temperaturu boje.



Podešavanje svjetline

Držite ruku ispred svjetiljke kako biste nestupnjevito prilagodili svjetlinu.

LED izvor svjetlosti

Fleksibilni zglob svjetiljke

Bežično punjenje

110 - 205KHz 37dBm

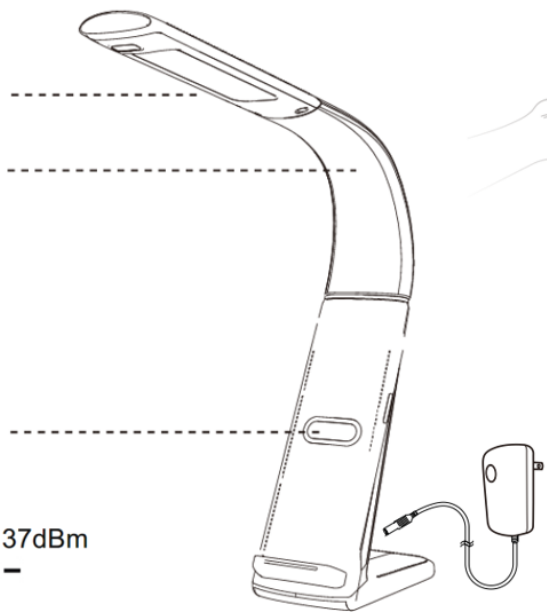

Bežično brzo punjenje (10 W)



Adaptor for small phones

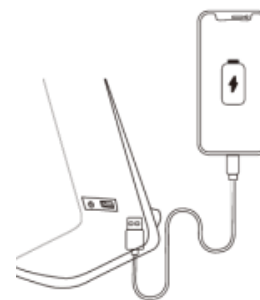

Punjenje preko USB-a (2,1 A)

HR: Ovaj proizvod sadržava izvor svjetlosti klase energetske učinkovitosti E.

Zamjena upravljačkog uređaja od strane krajnjeg kupca.

LED izvor svjetlosti nije zamjenjiv

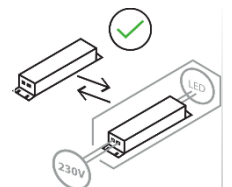

1 X LED 7W + 1 X Wireless Charging 10W
AC 220-240V ~50/60Hz



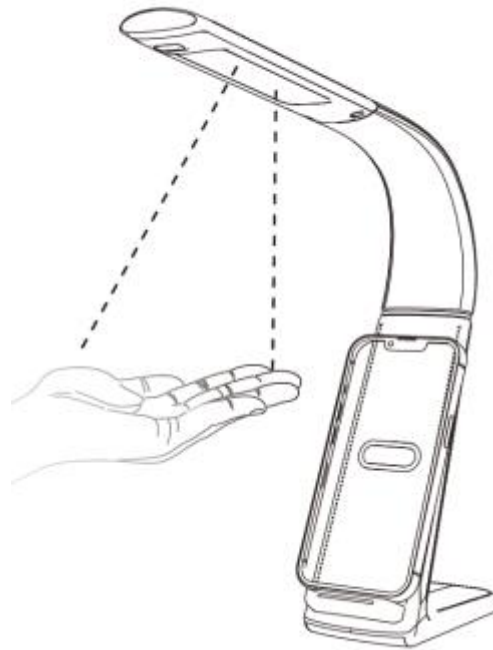
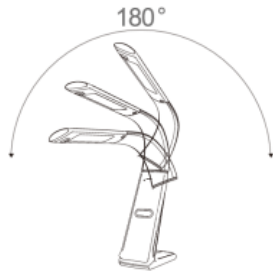

**Регулиране на
цветната температура**

Движете ръката си пред лампата, за да я включите или изключите и да регулирате цветната температура.



**Регулиране на
яркостта**

Дръжте ръката си пред лампата, за да регулирате плавно яркостта.

зонален източник на светлина

гъвкаво рамо на лампата

безкабелно зареждане 10 - 205KHz 37dBm

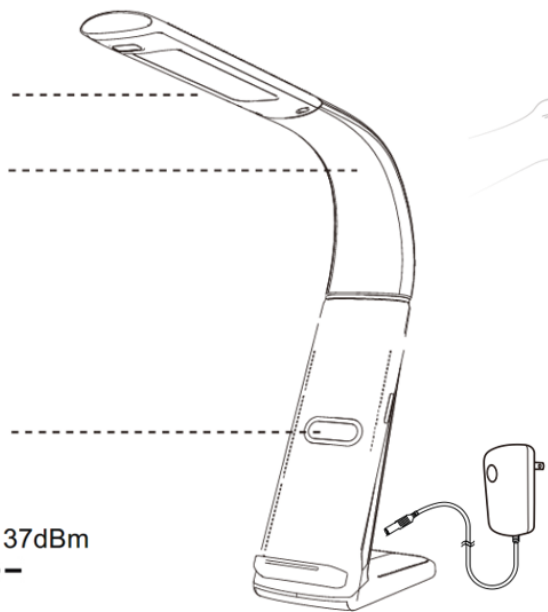

безкабелно бързо зареждане (10 W)



Adaptor for small phones

зареждане чрез USB (2,1 A)

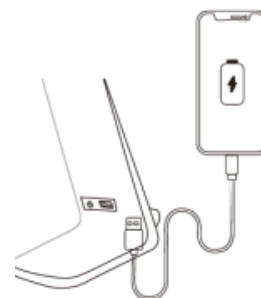

ВГ: Този продукт съдържа източник на светлина с клас на енергийна ефективност **Е**.

Смяна на пусково-регулиращата апаратура от крайния клиент.

LED светлинният източник не може да се сменя.

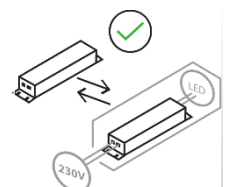

1 X LED 7W + 1 X Wireless Charging 10W
AC 220-240V ~50/60Hz



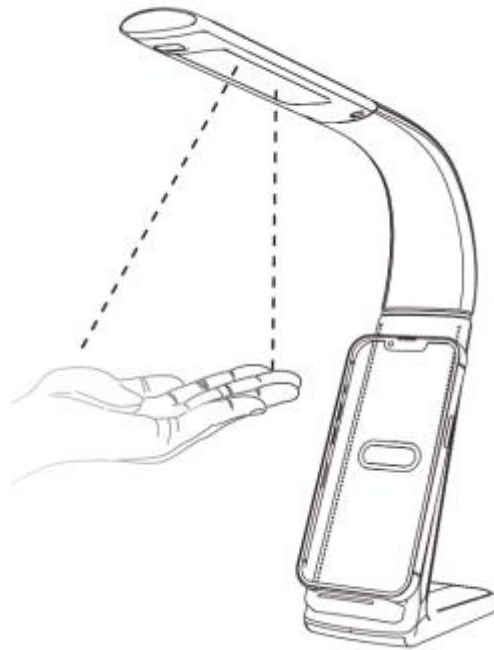
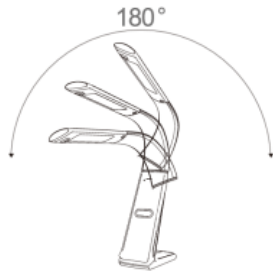

Reglarea temperaturii de culoare

Mișcați mâna în fața lămpii pentru a o aprinde sau a o stinge și pentru a regla temperatura de culoare.



Reglarea luminozității

Țineți mâna în fața lămpii pentru a regla continuu luminozitatea.

Sursă de lumină uniformă

Braț flexibil

Încărcare wireless

110 - 205KHz 37dBm

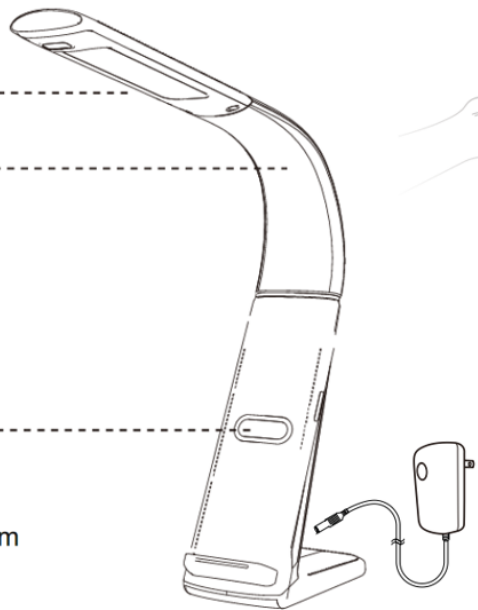

Încărcare rapidă wireless (10 W)



Adaptor for small phones

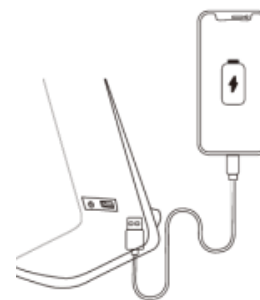

Încărcare prin USB (2,1 A)

RO: Acest produs conține o sursă de lumină din clasa de eficiență energetică E.

Înlocuirea dispozitivului de comandă de către clientul final

Sursa de lumină LED nu se înlocuiește

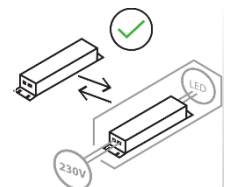

1 X LED 7W + 1 X Wireless Charging 10W
AC 220-240V ~50/60Hz



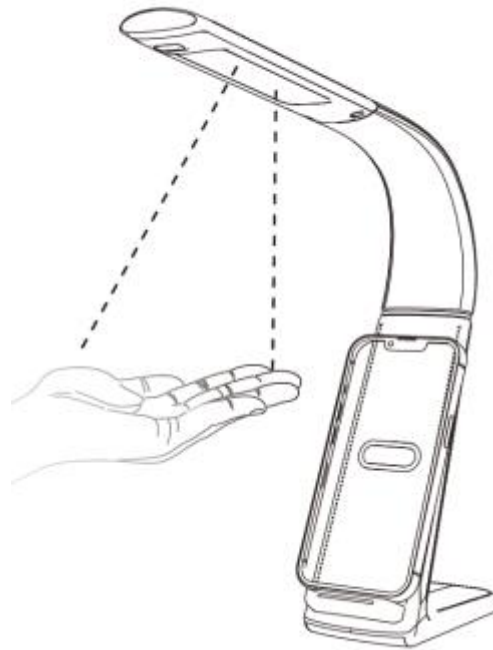
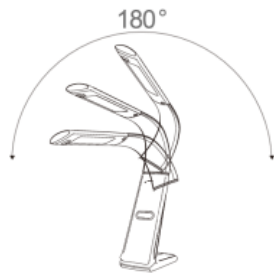

podešavanje temperature boje

Pomerajte ruku ispred lampe kako biste je uključili ili isključili i podesili temperaturu boje.



podešavanje jačine svetlosti

Držite ruku ispred lampe kako biste bestepeno podesili jačinu svetlosti.

ravan izvor svetla

fleksibilan zglob lampe

bežično punjenje

110 - 205KHz 37dBm

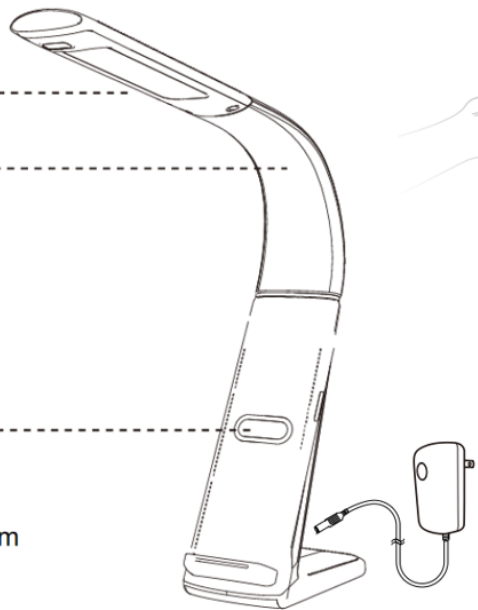

bežično brzo
punjenje (10 W)



Adaptor for
small phones

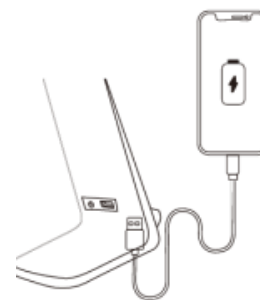

punjenje
preko USB-a
(2,1 A)

SR: Ovaj proizvod sadrži izvor svetla klase energetske efikasnosti E.

Zamena upravljačkog uređaja od strane krajnjeg kupca.

Izvor LED svetla se ne može menjati.

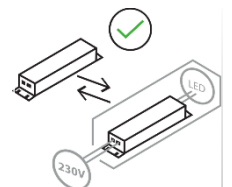

1 X LED 7W + 1 X Wireless Charging 10W
AC 220-240V ~50/60Hz



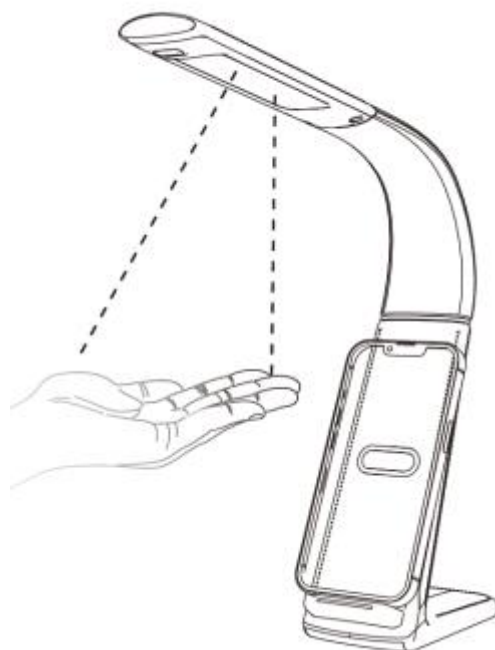
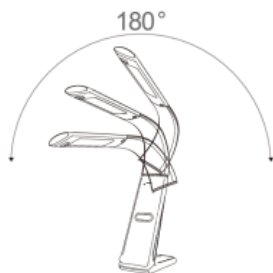

Régler la température de couleur

Mettez votre main devant la lampe pour l'allumer ou l'éteindre et régler la température de couleur.



Régler la luminosité

Tenez votre main devant la lampe pour régler progressivement la luminosité.

Source d'éclairage de surface

Bras de lampe flexible

Recharge sans fil

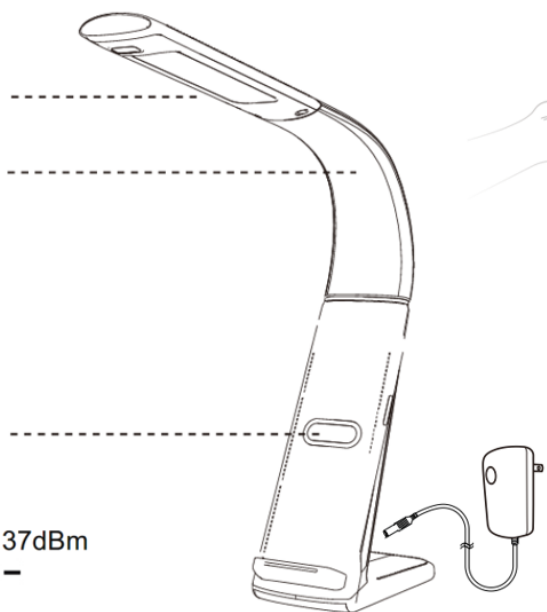

110 - 205KHz 37dBm
+ -



Recharge rapide sans fil (10 W)



Adaptor for small phones

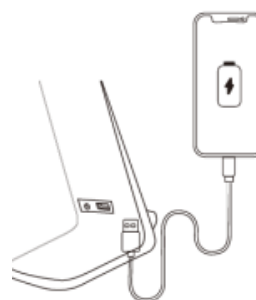

Recharger par USB (2,1 A)

FR: Ce produit contient une source lumineuse de classe d'efficacité énergétique E.

Remplacement de l'appareillage de commande par l'utilisateur final.

Ampoule à LED non remplaçable.

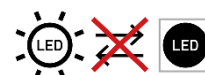
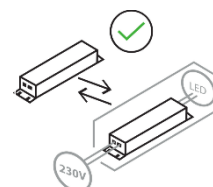

1 X LED 7W + 1 X Wireless Charging 10W
AC 220-240V ~50/60Hz

