

Service

Name

NILO

Typ

T 86- KOMMODE

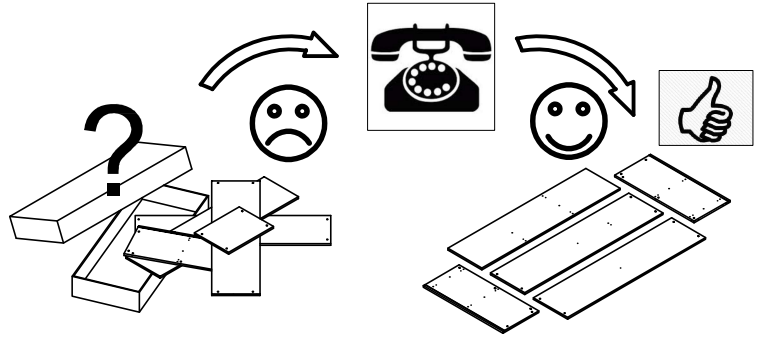
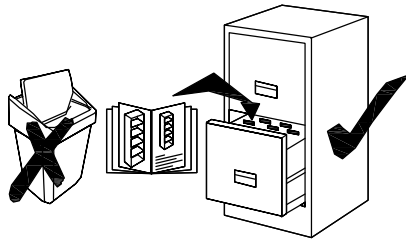

- ① 649×374×19
- ② 649×374×19
- ③ 962×352×19
- ④ 962×352×19
- ⑤ 609×60×18
- ⑥ 607×290×18
- ⑦ 594×300×120
- ⑧ 796×320×20
- ⑨ 796×320×20
- ⑩ 644×156×20
- ⑪ 60×60×15
- ⑫ 978×625×3,2

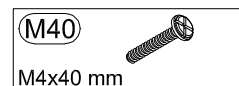
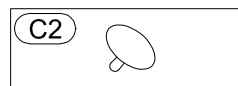
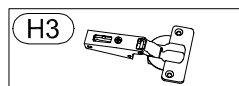
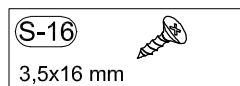
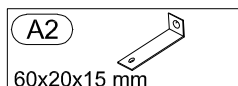
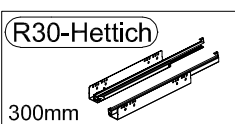
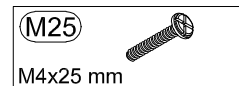
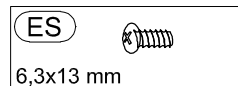
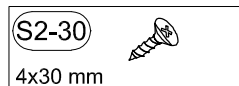
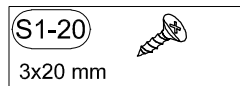
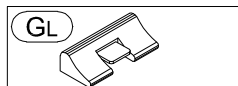
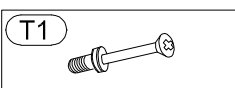
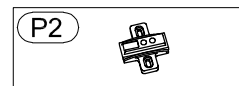
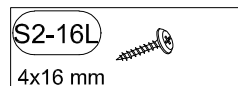
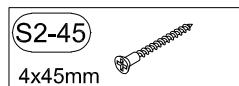
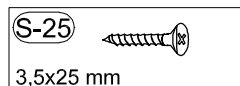
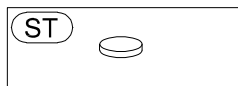
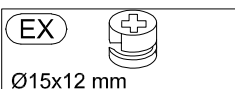
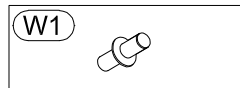
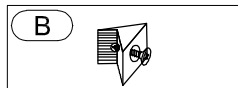
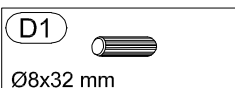
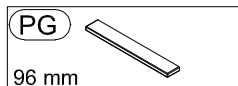
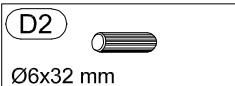
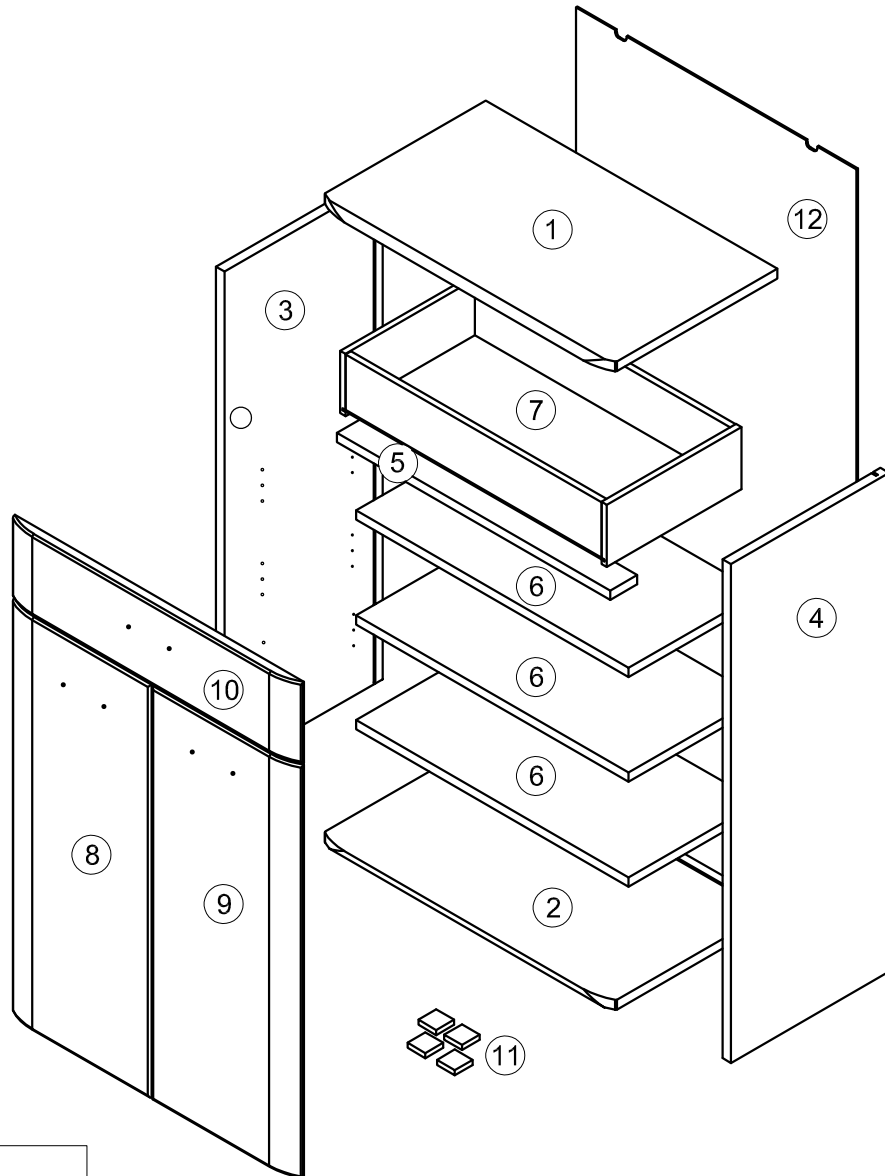

Modellname:

NILO

MONTAGEANLEITUNG

TYPE T86 - KOMMODE

1/1



1 Person

10
Min.

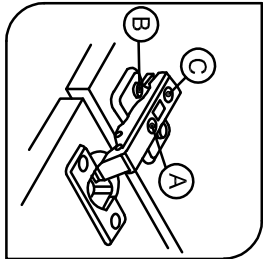
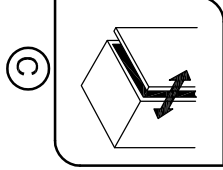
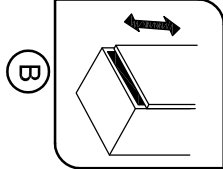
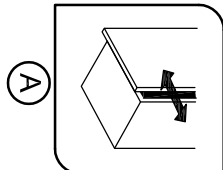
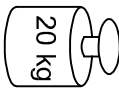
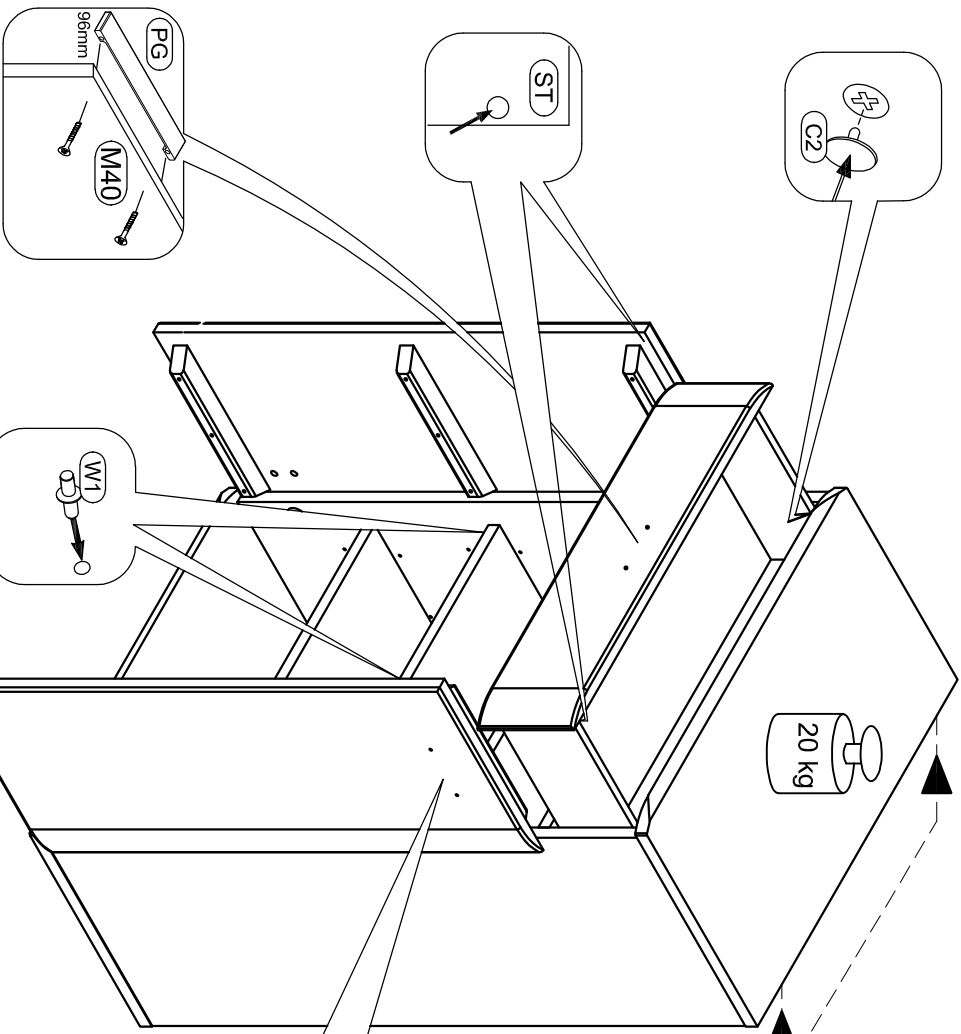
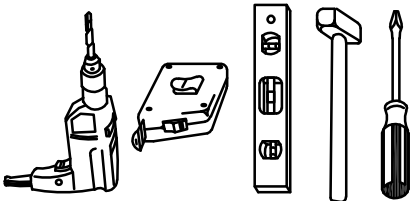

Schubblade mit 3x20mm schrauben an die Unterführungsschleife befestigt

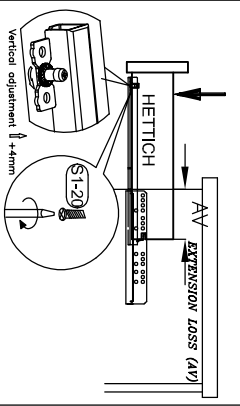

| | | | |
|------------------------------|--------------------------|--------------------------------|------------------------------|
| M25 M4x25 mm x4 | W1 x12 | S2-16L 4x16 mm x2 | M40 M4x40 mm x2 |
| C2 x10 | PG 96 mm x3 | A2 60x20x15 mm x2 | ST x4 |

