

24270025/08
24270025/17
1391788
1391792

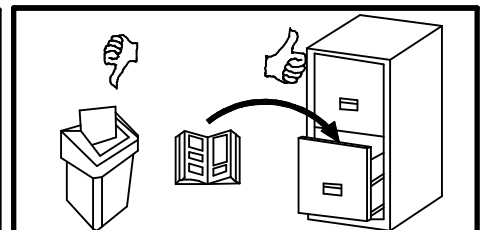

A	B1	B2	C1	C2	C3	D
1	S703-0001	-	551	495	16	3/3
2	S703-1001	-	1132	404	16	3/3
3	S703-1002	-	1132	404	16	3/3
4	S703-1006	-	513,5	384	16	1/3
5	S703-1011	-	570,5	384	16	1/3
6	S703-2001	-	1000	422	22	2/3
7	S703-2002	-	1000	422	22	2/3
8	S703-2003	-	970	404	12	2/3
9	S703-3001	-	966	384	16	1/3
10	S703-3002	-	966	384	16	1/3
11	S703-3003	-	966	384	16	1/3
12	S703-3004	-	475	383	16	1/3
13	S703-5301	-	966	60	32	3/3
14	S703-9001	-	1126	487	2,5	3/3
15	S703-9002	-	1126	487	2,5	3/3

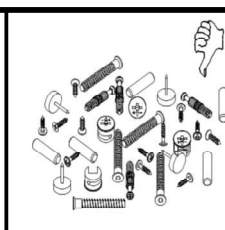

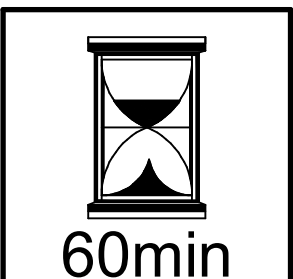
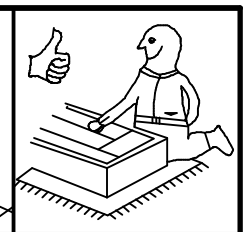
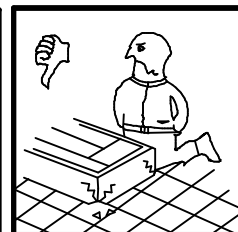
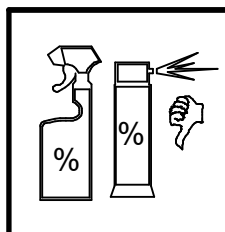
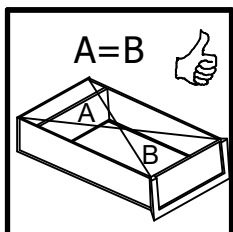
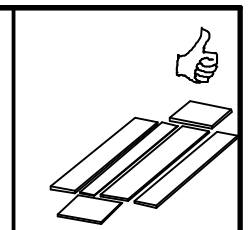
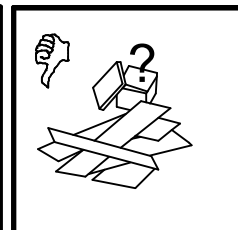
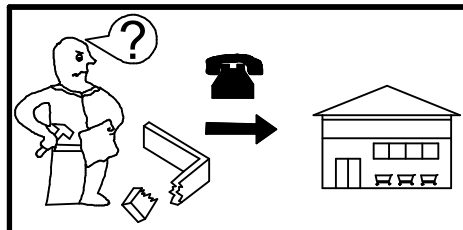
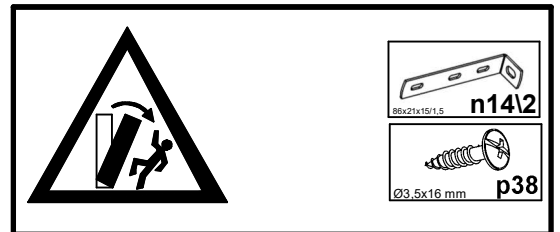
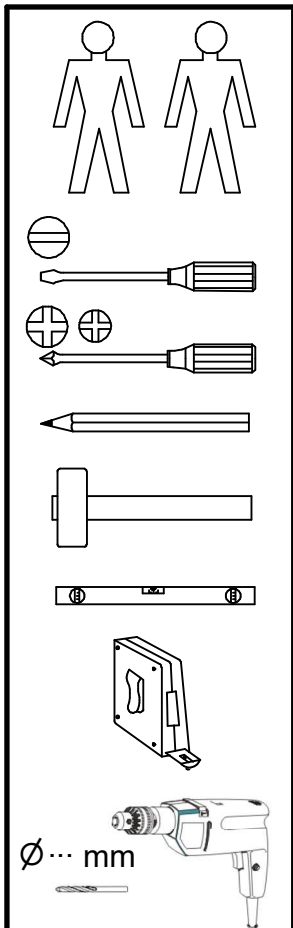
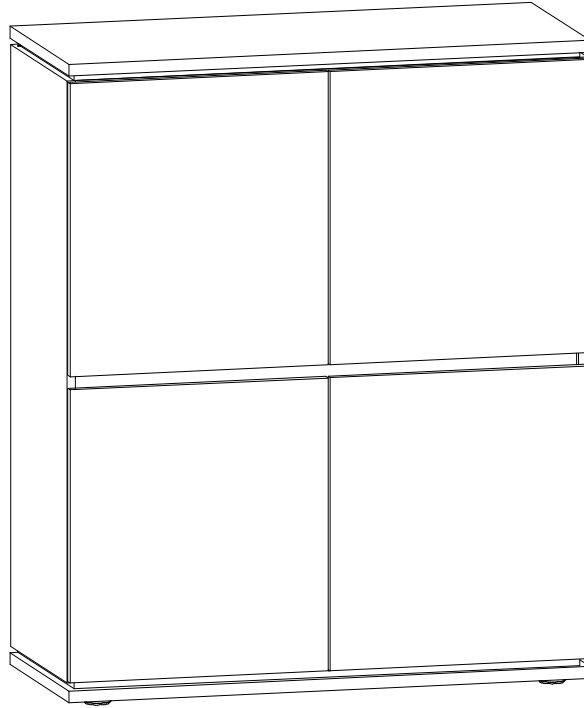
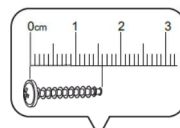
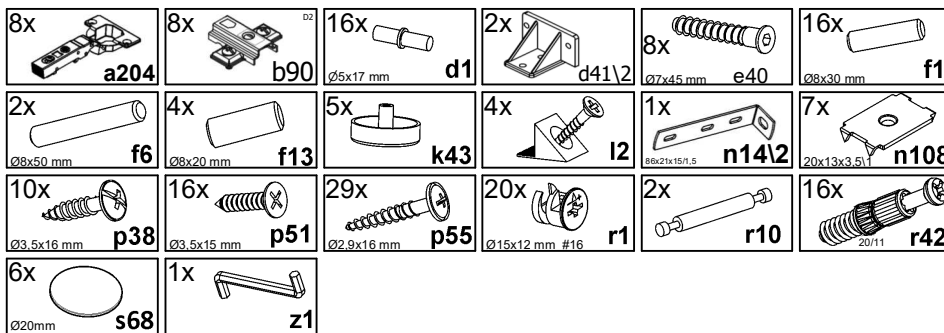
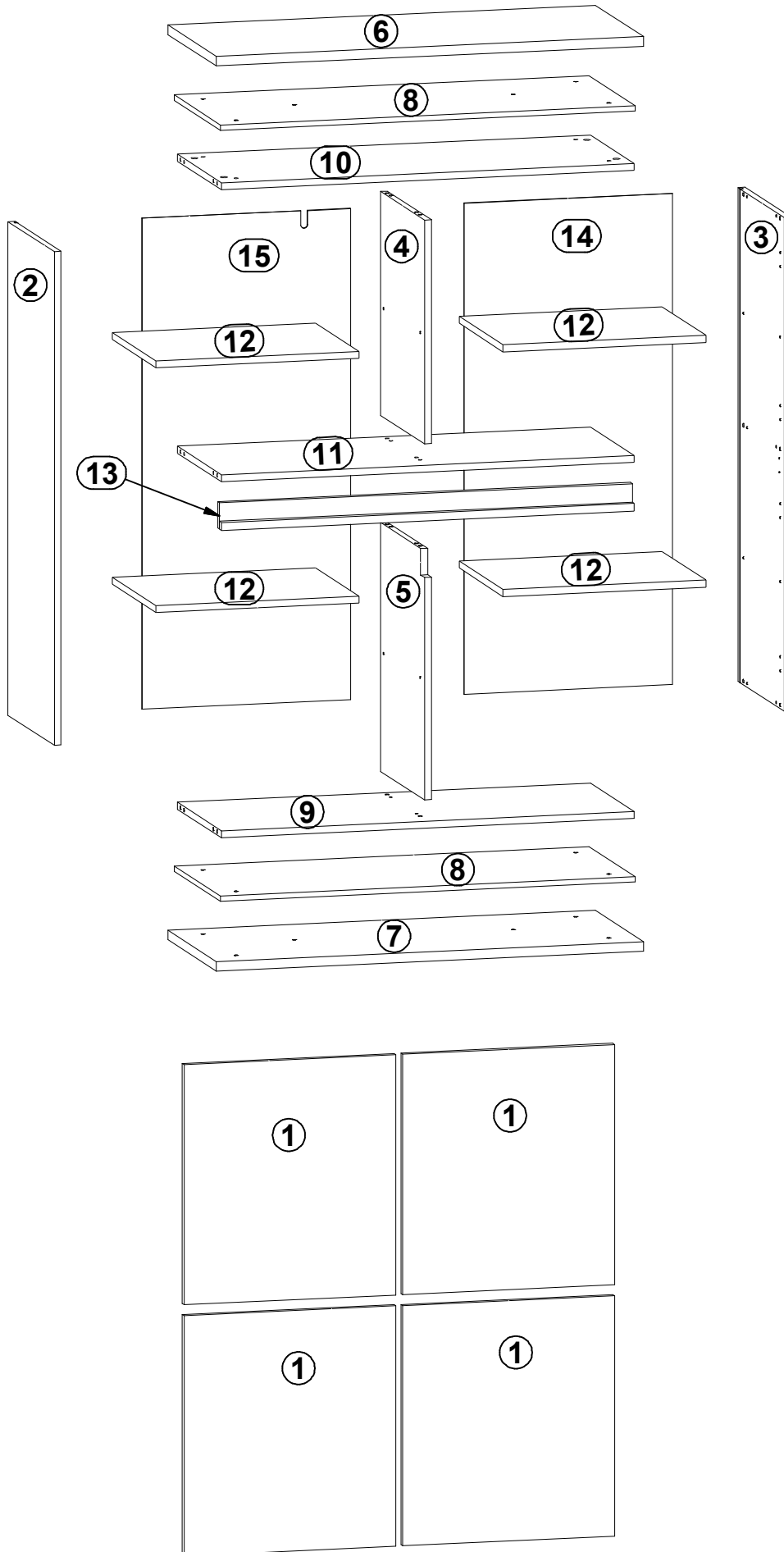

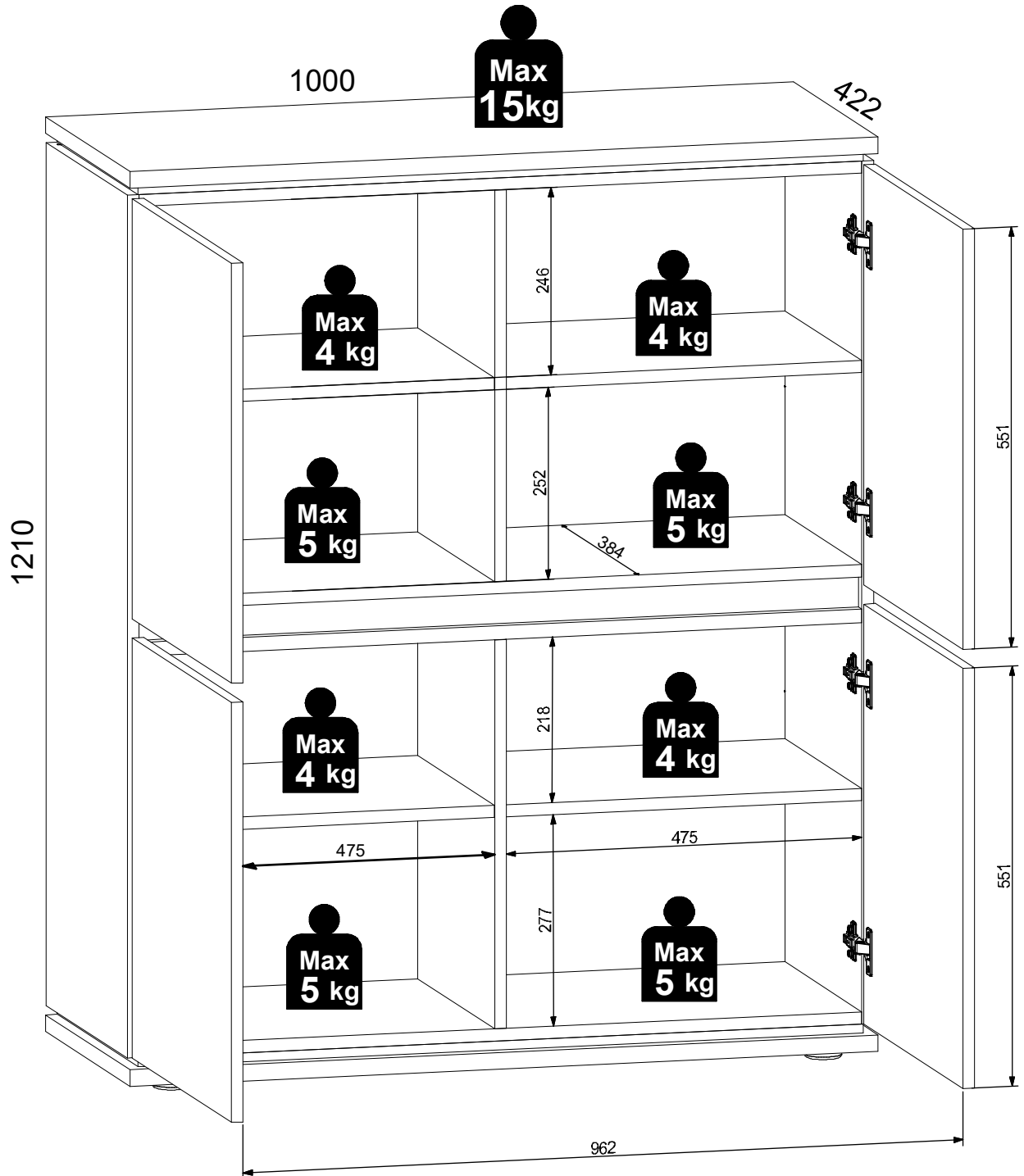

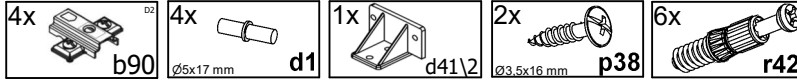

1 ▶

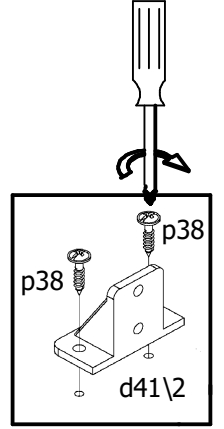
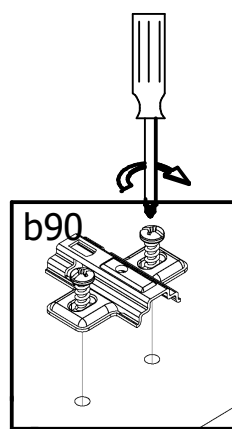
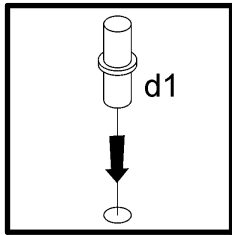
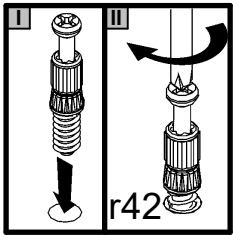
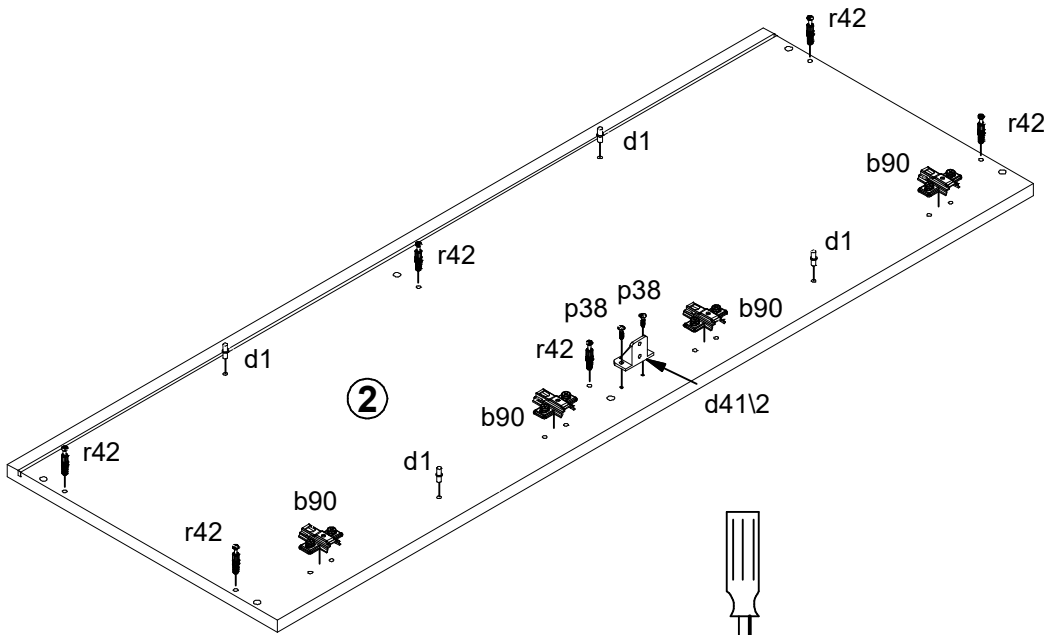

2 ▶

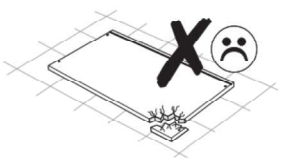
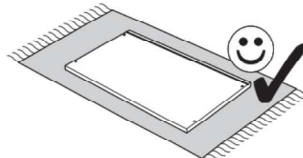
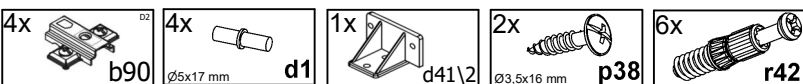
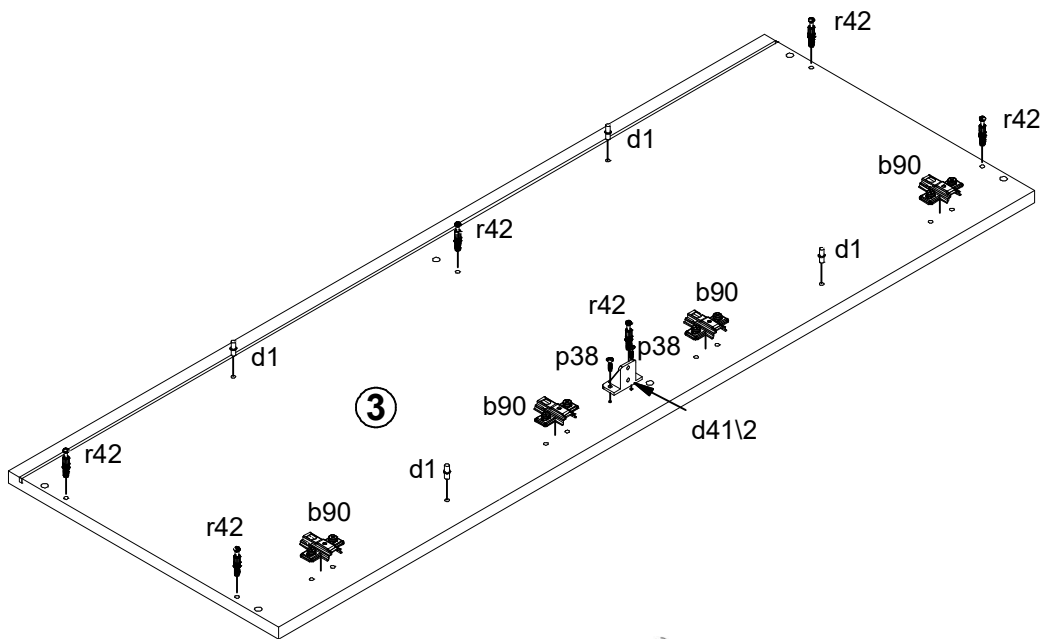



4x Ø5x17 mm d1	2x Ø8x30 mm f1	2x Ø8x50 mm f6	4x Ø15x12 mm #16 r1	2x r10
----------------------	----------------------	----------------------	---------------------------	-----------

3 ▶

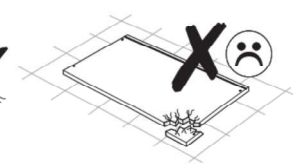
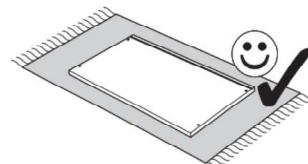
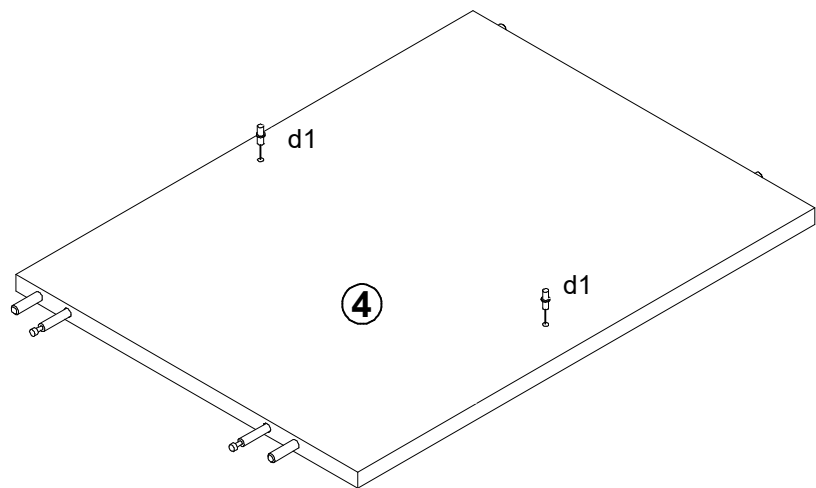
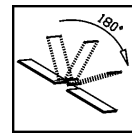
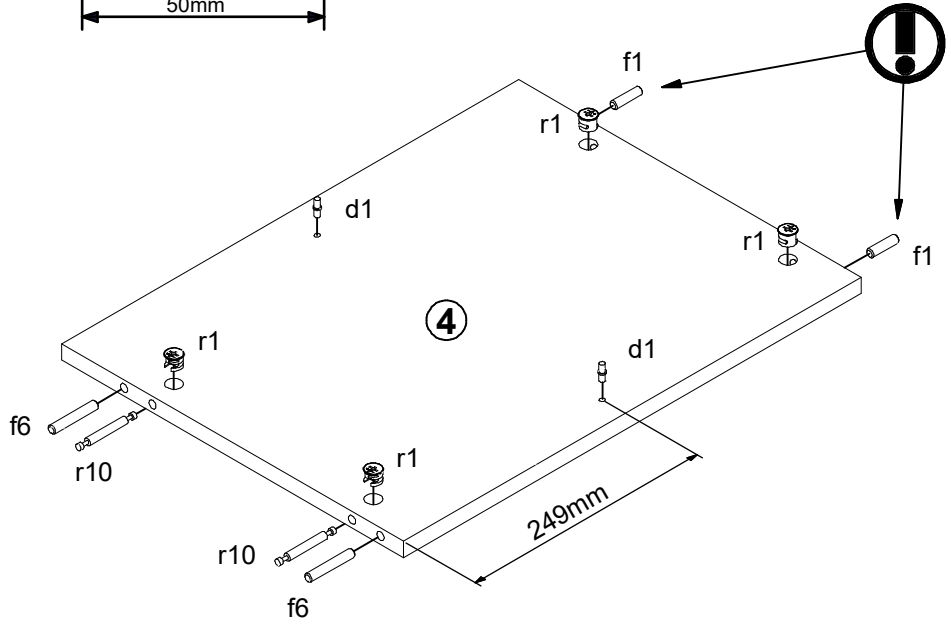
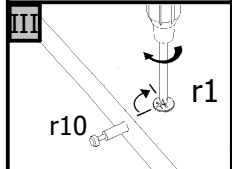
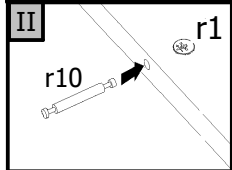
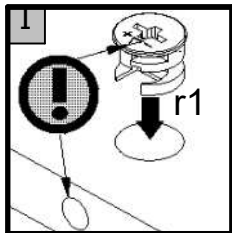
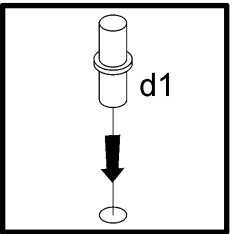
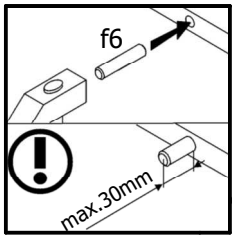
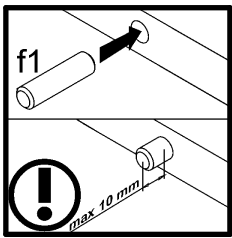
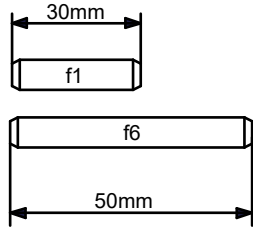

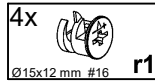
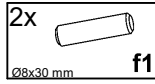
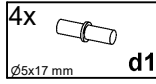

4 ▶

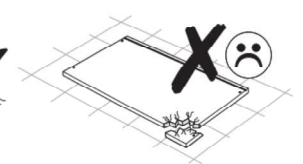
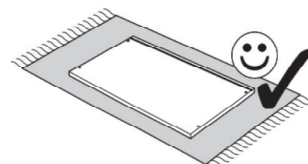
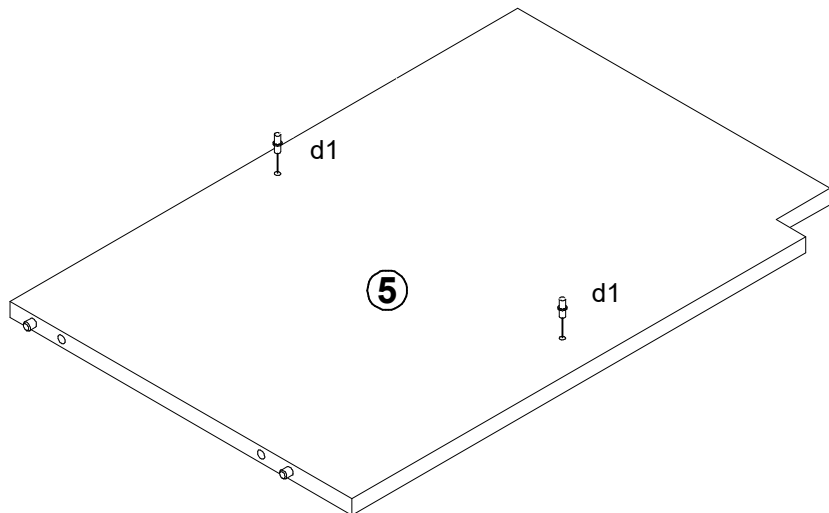
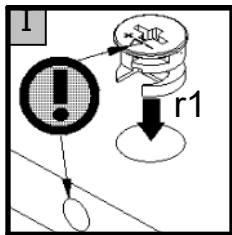
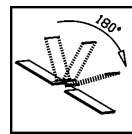
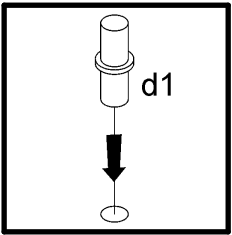
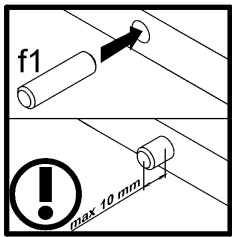
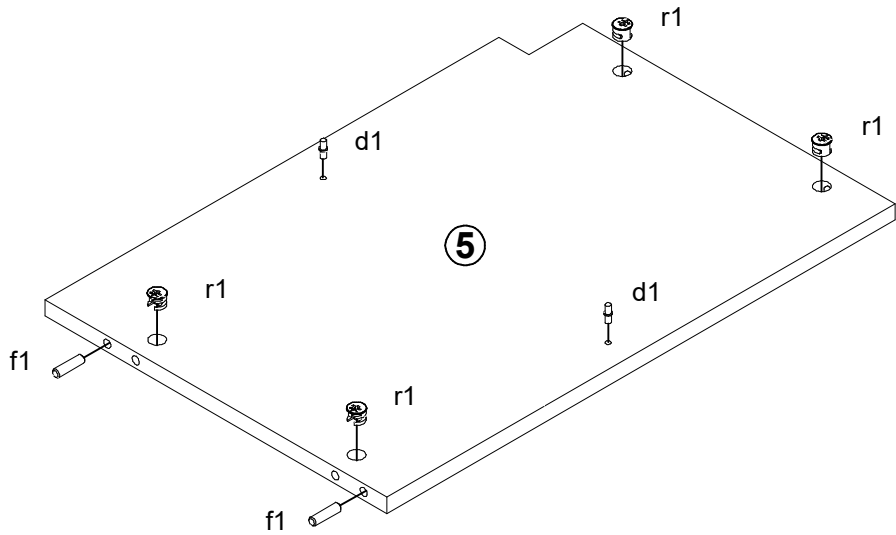

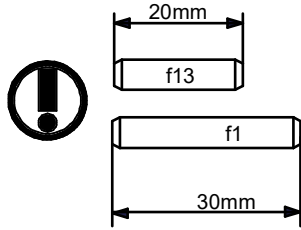
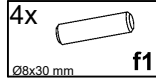

5 ▶

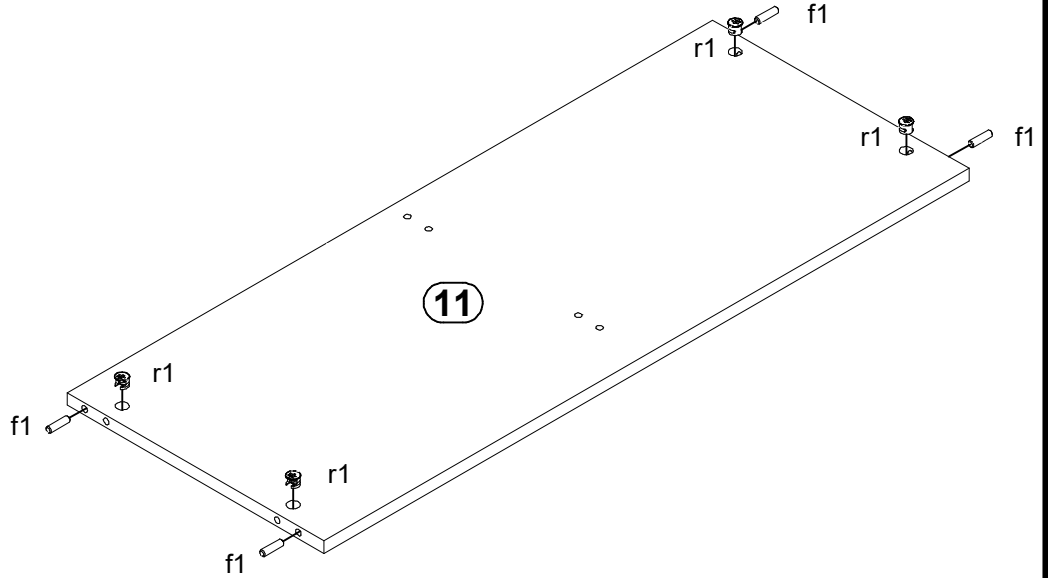
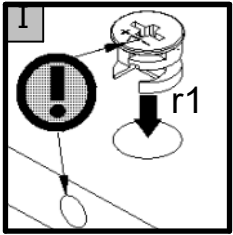
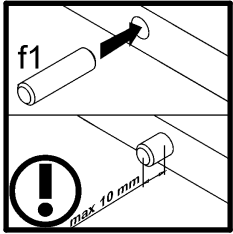

6 ▶

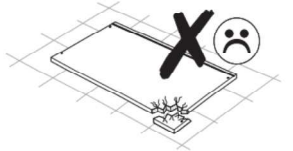
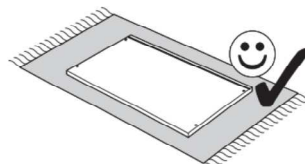
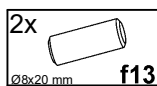
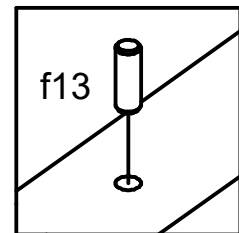
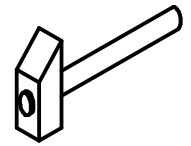
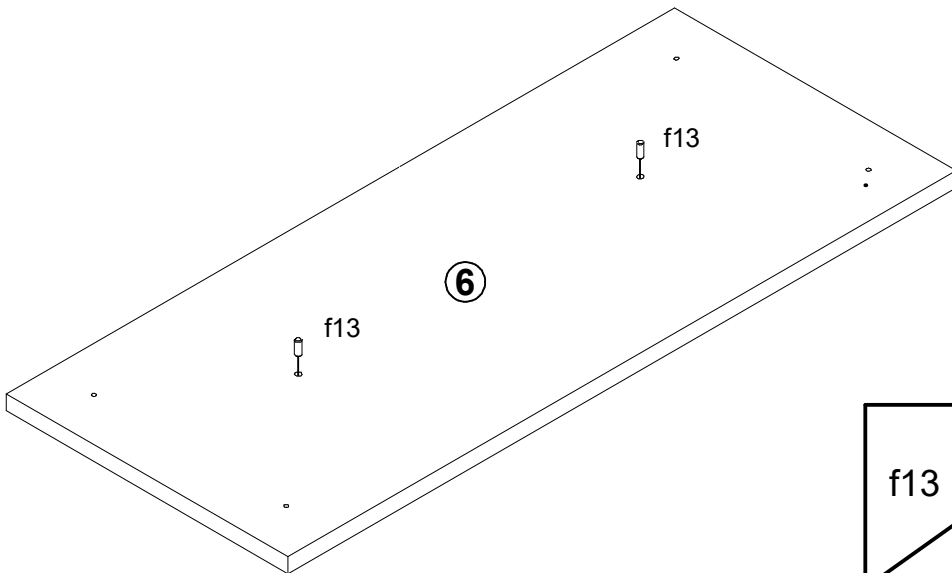

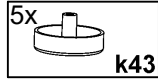
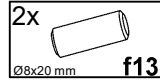

7 ▶

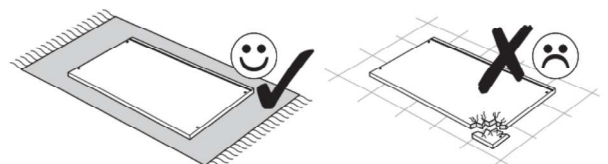
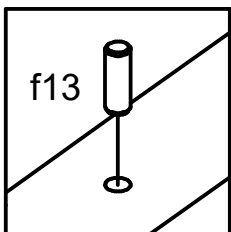
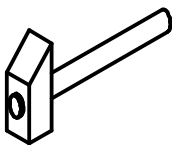
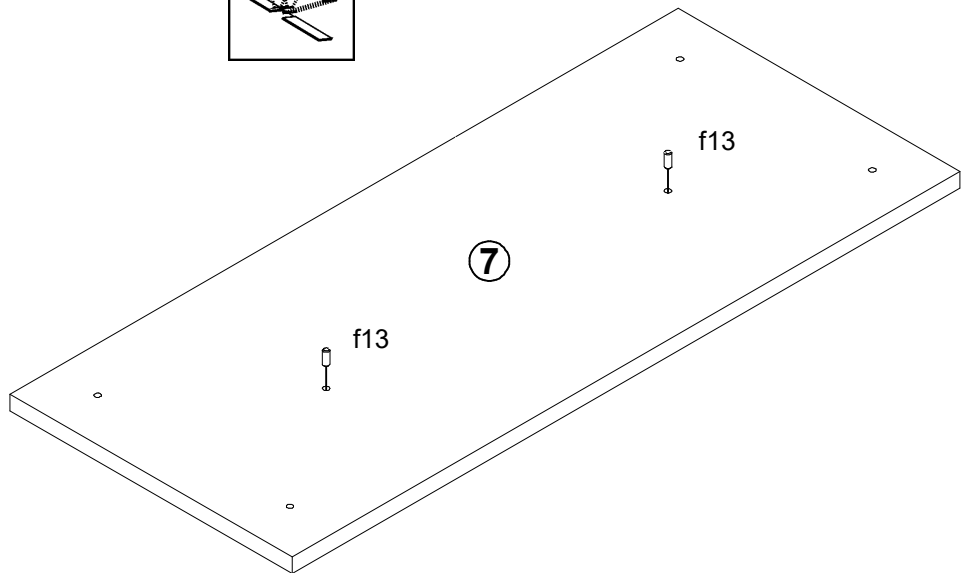
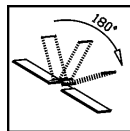
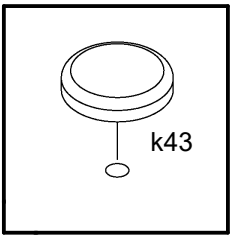
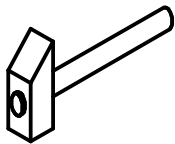
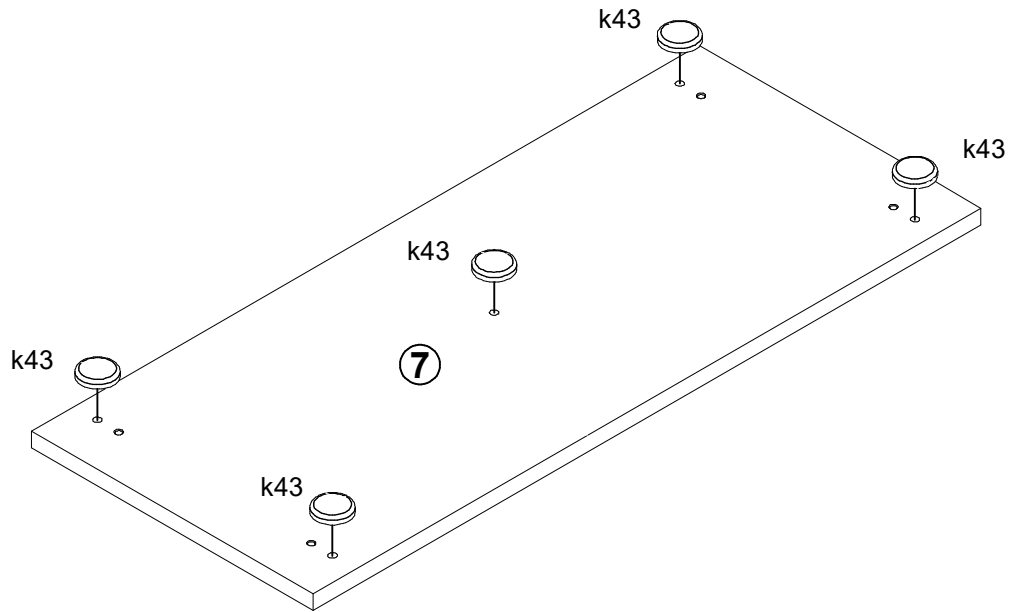

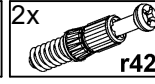
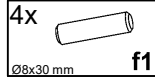

8 ▶

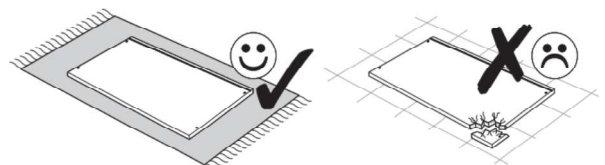
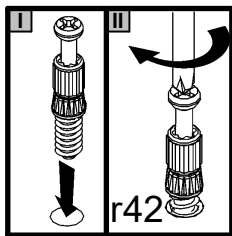
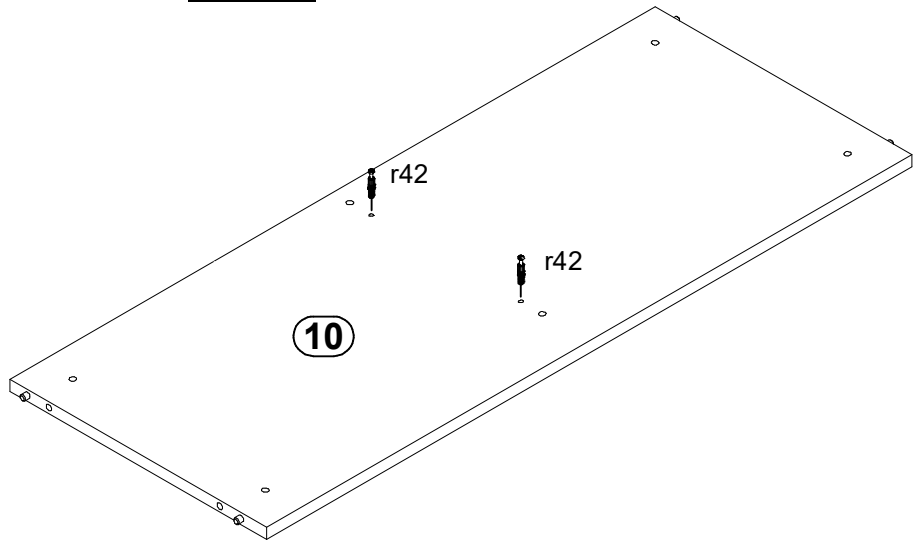
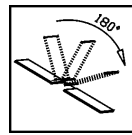
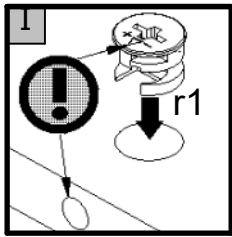
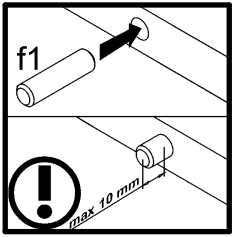
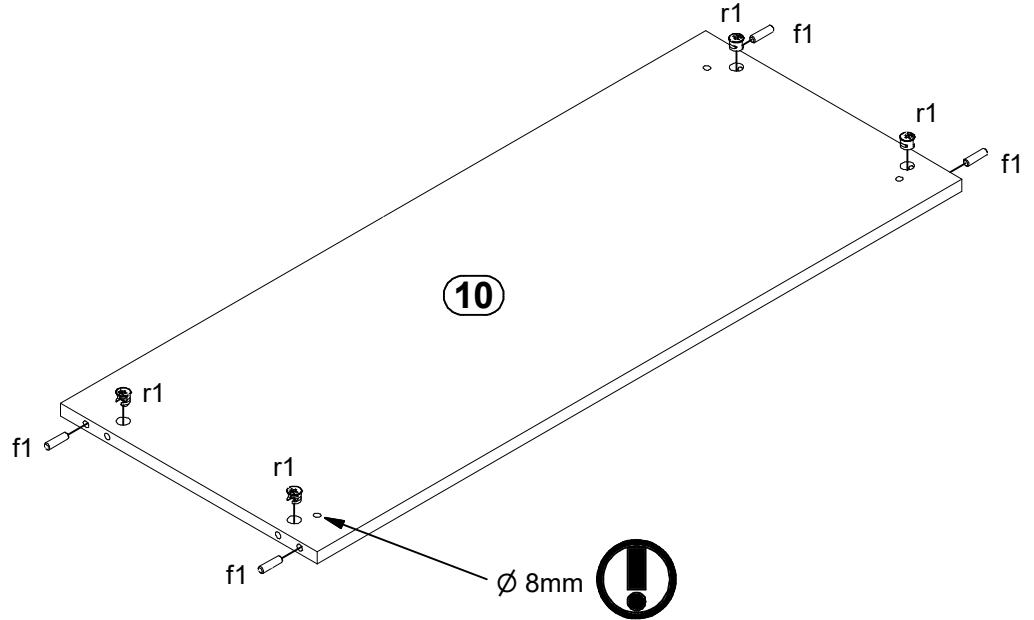

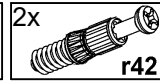
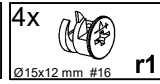
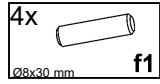

9 ▶

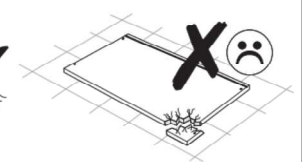
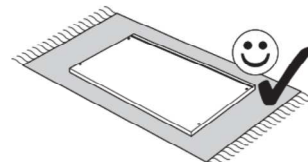
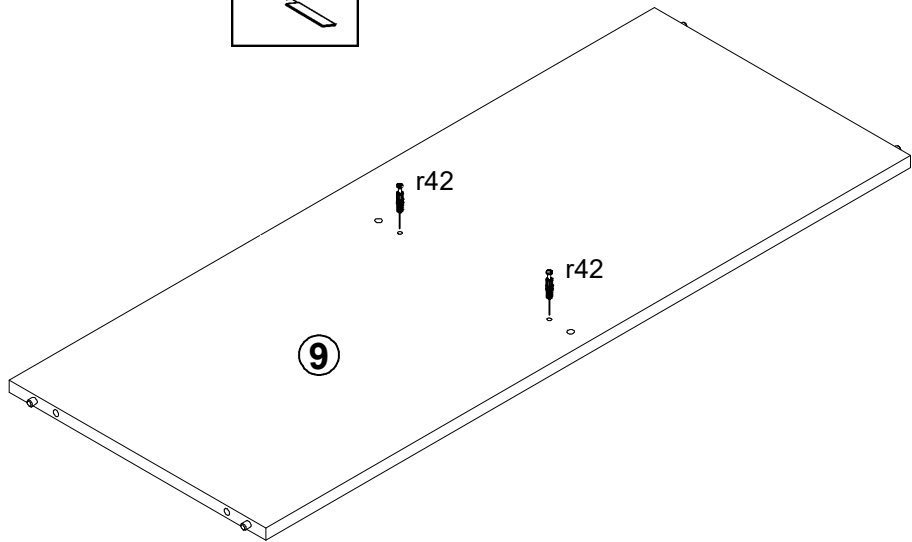
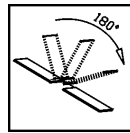
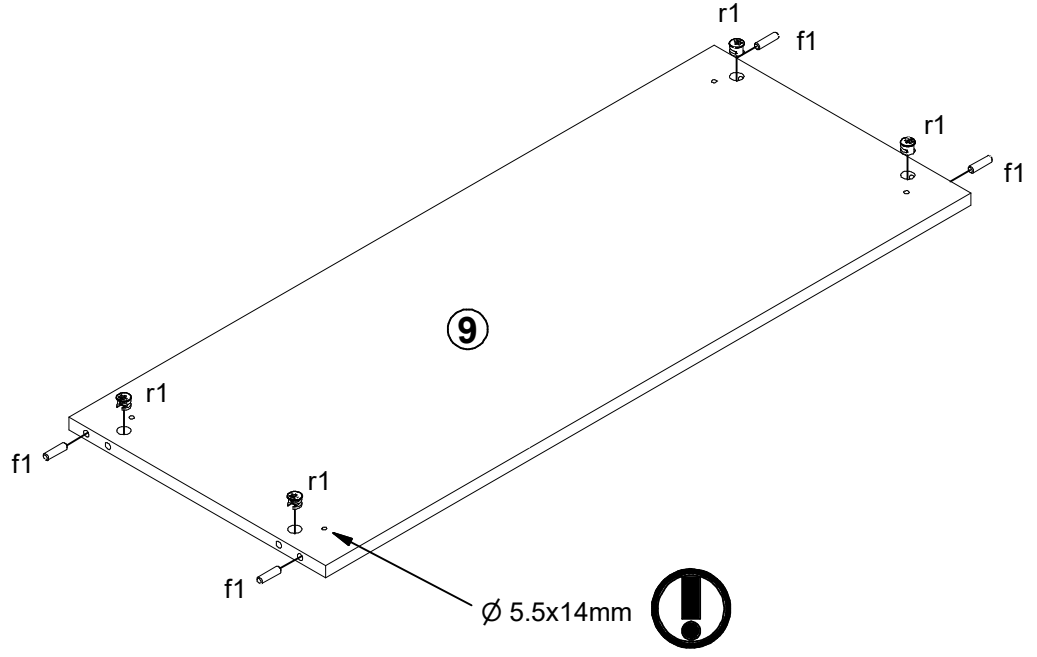
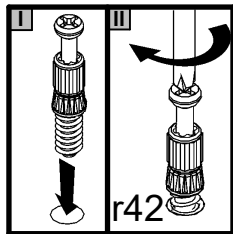
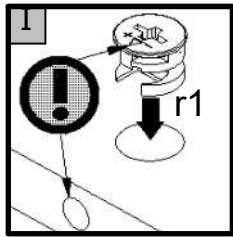
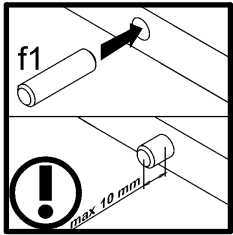



10

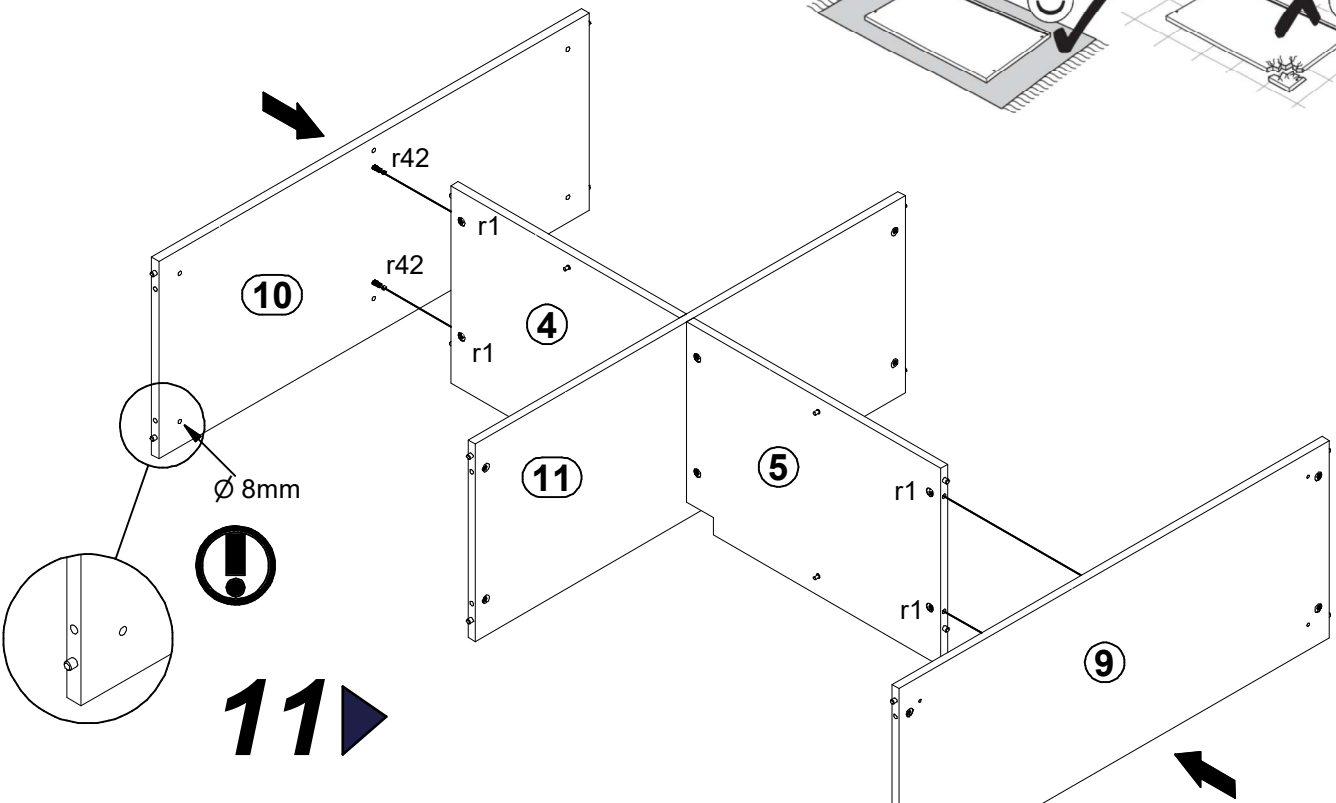
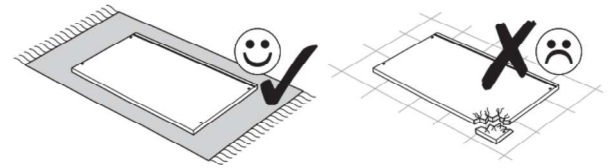
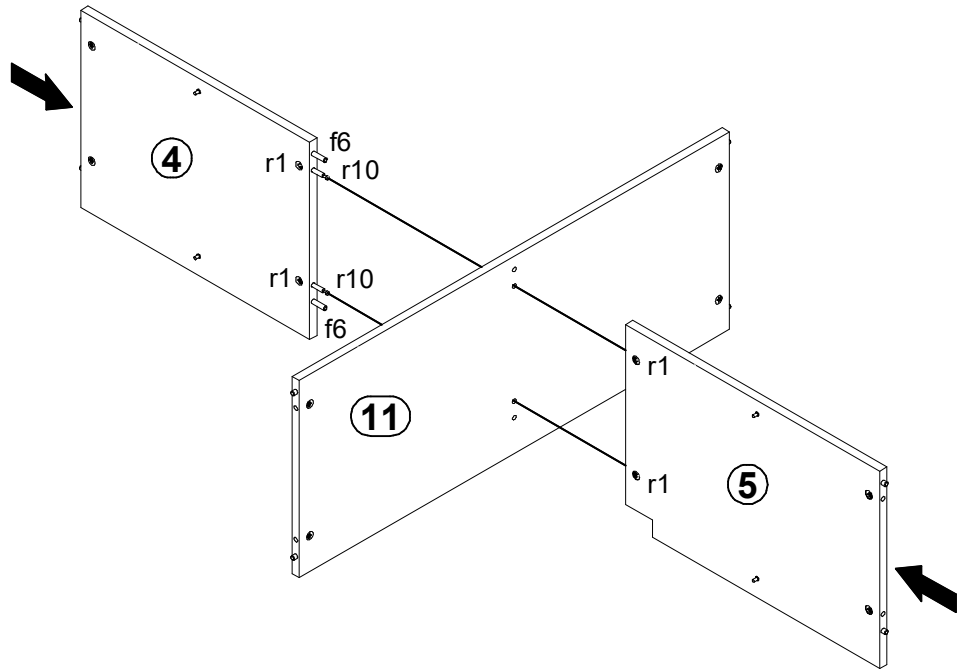
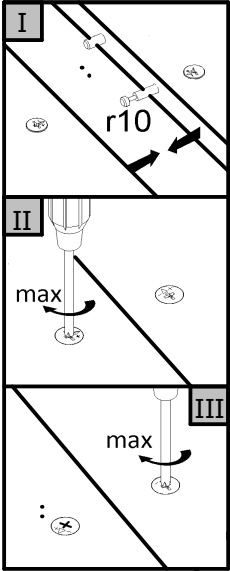

11

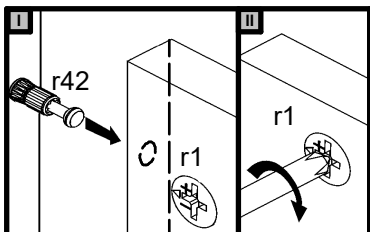



12 ▶

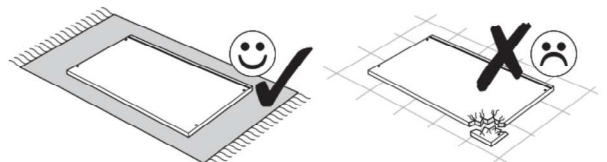
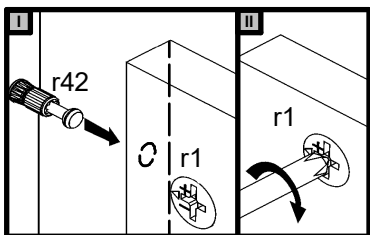
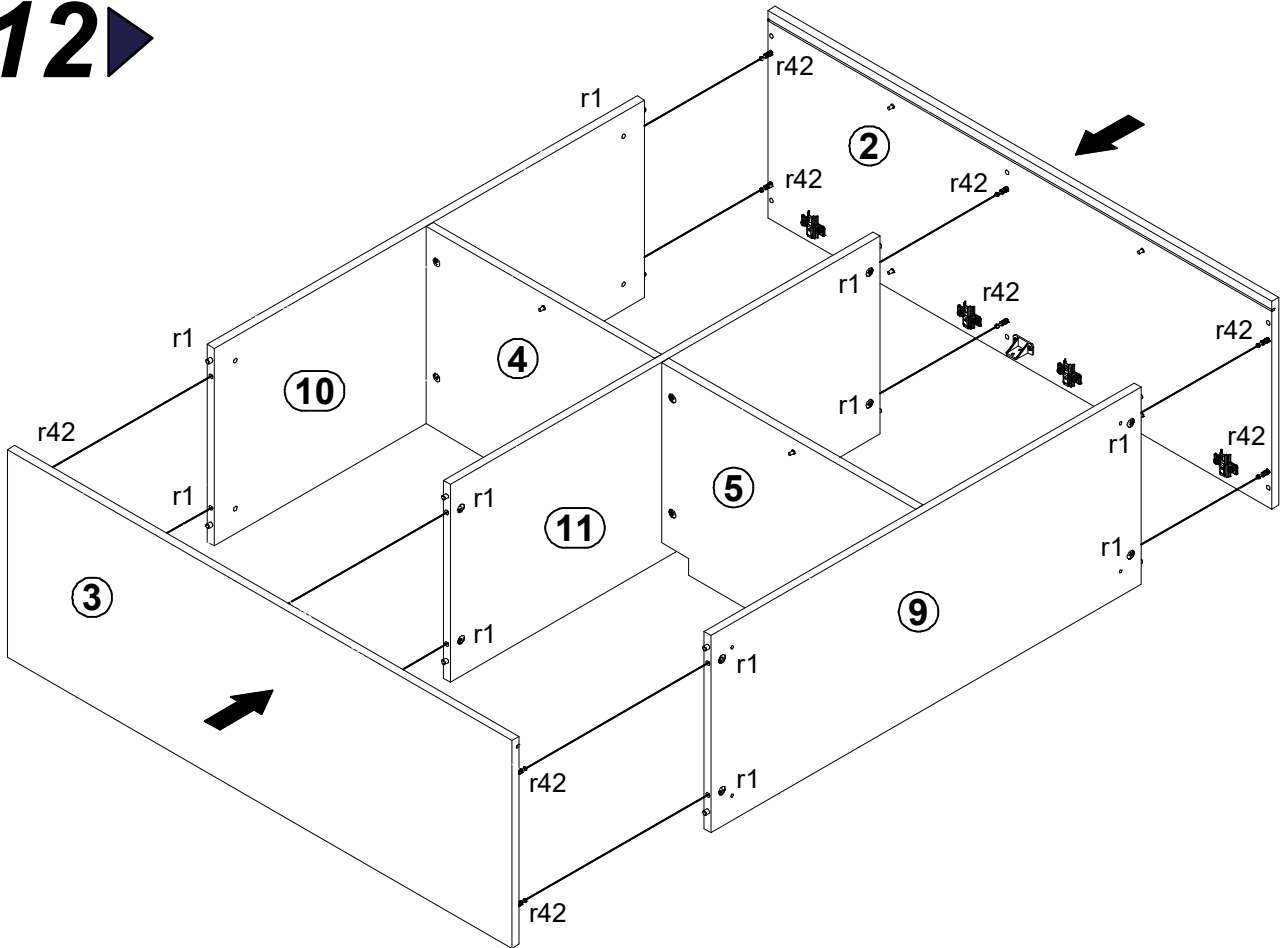



13 ▶

I

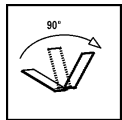
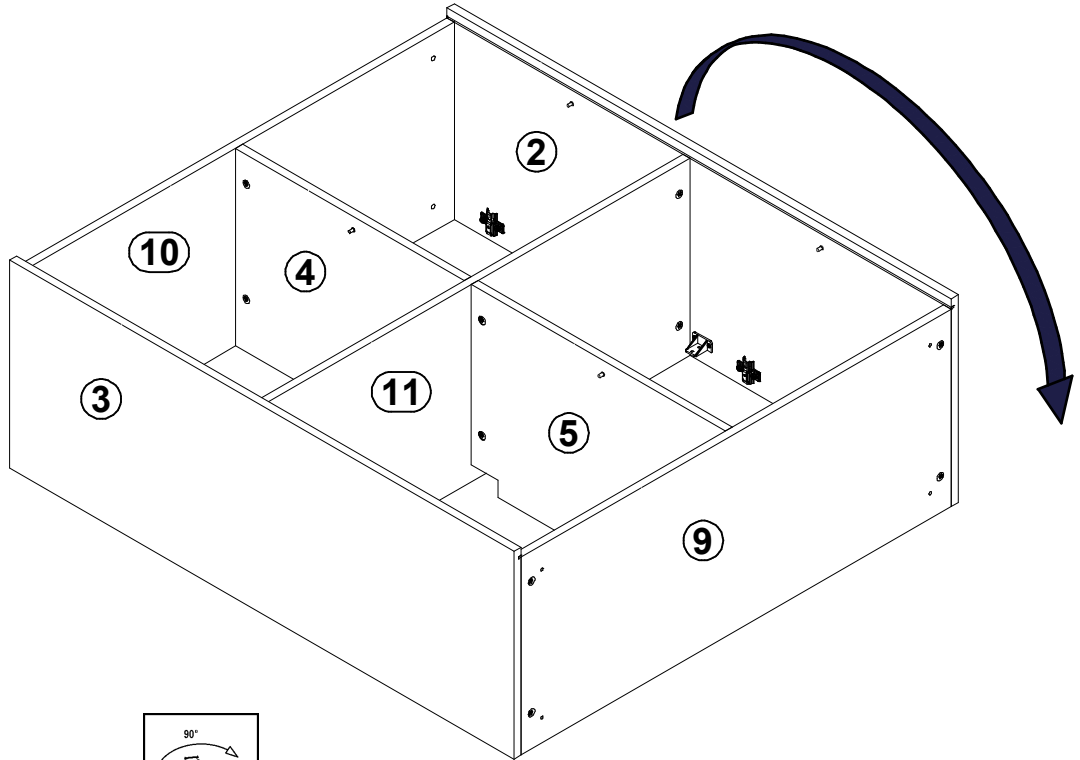

II

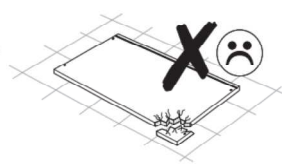
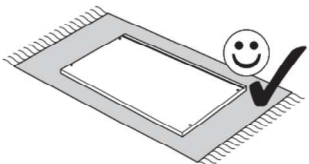
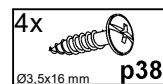
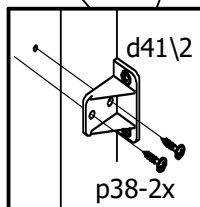
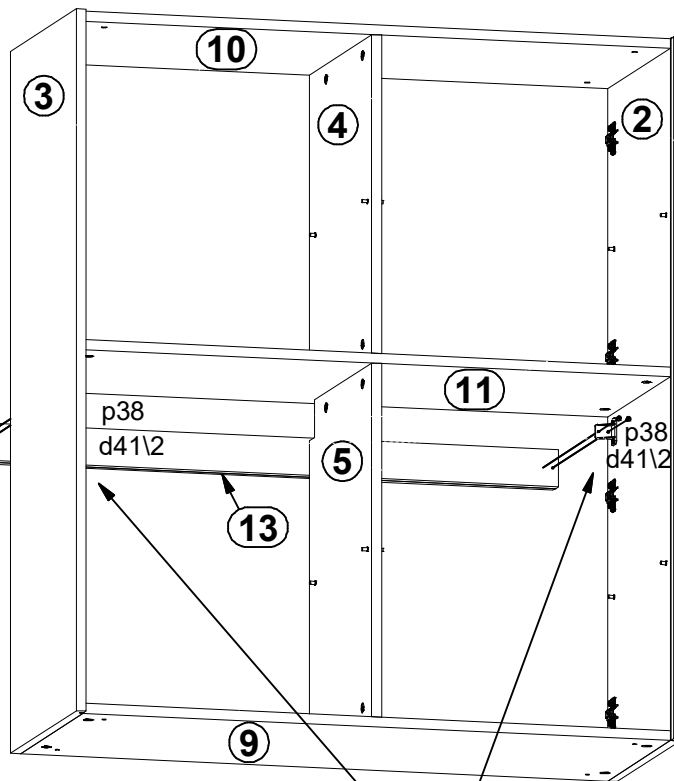
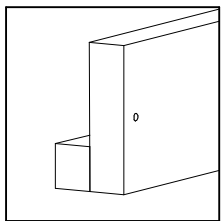

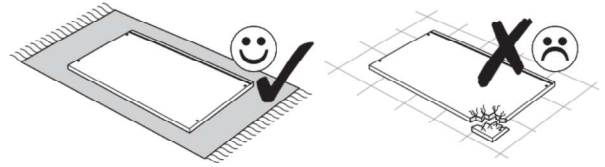

14 ▶

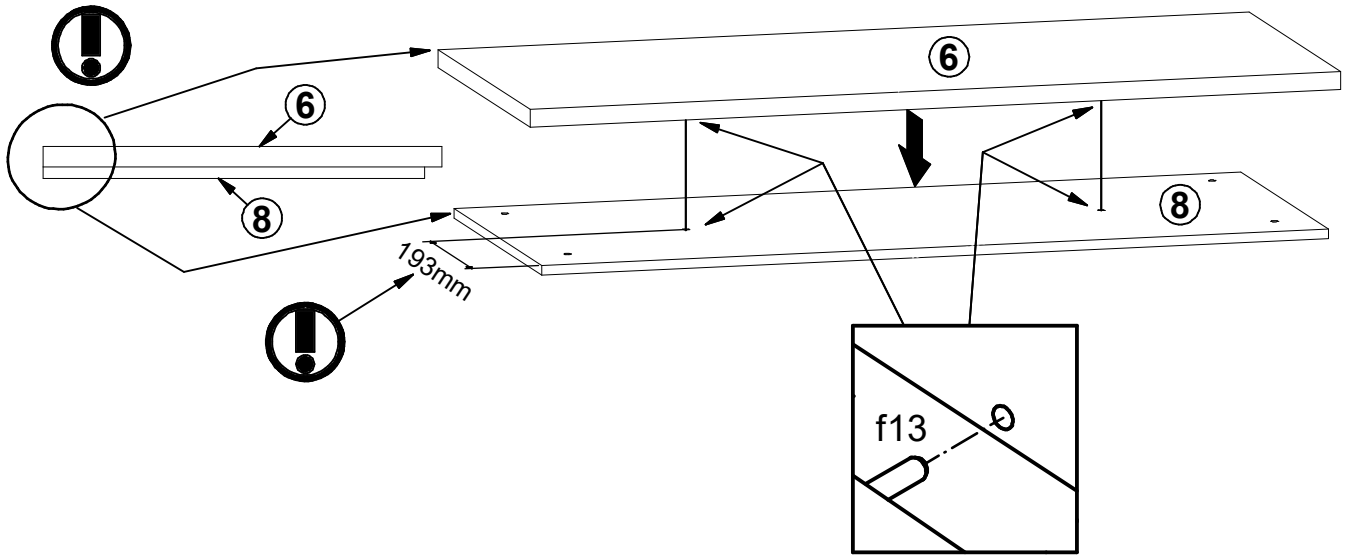

15 ▶

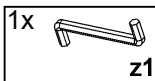
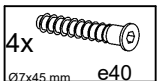
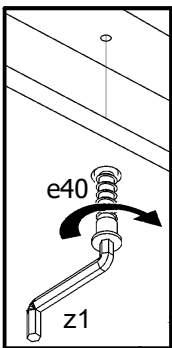
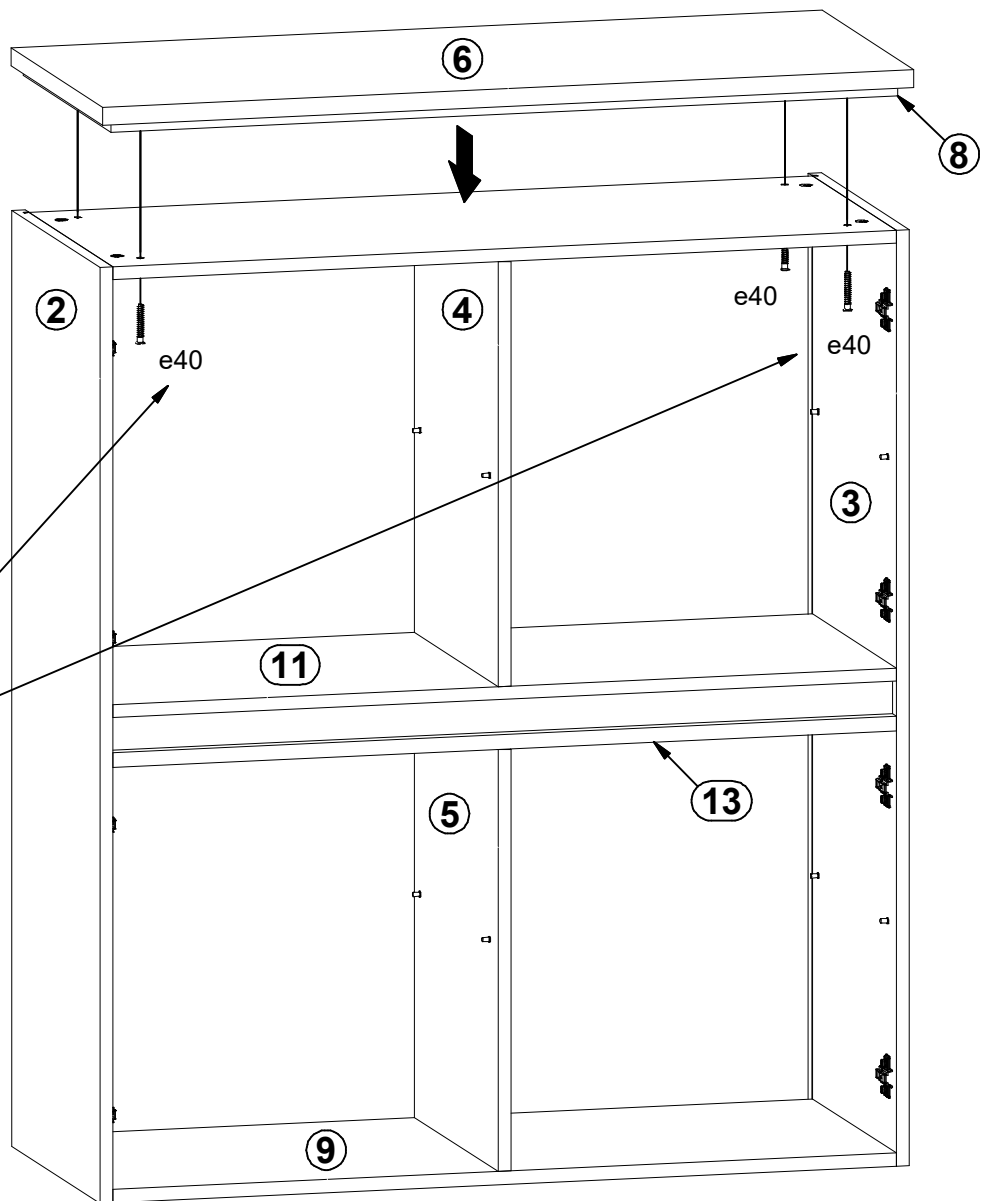

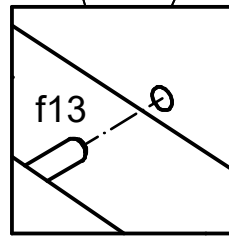
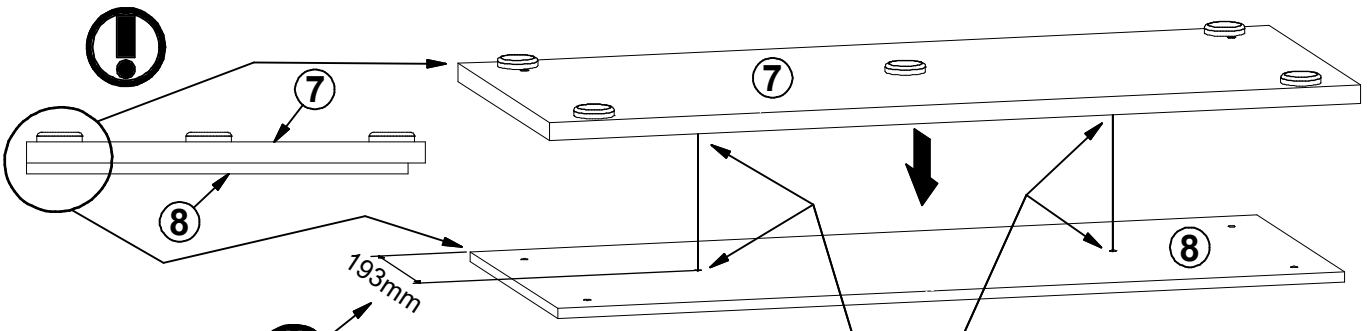

16 ▶

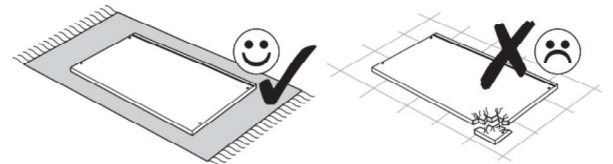

17 ▶

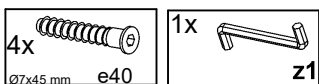
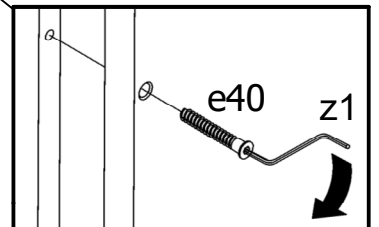
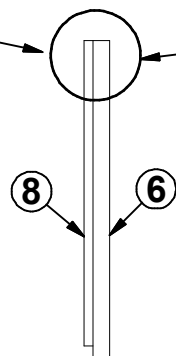
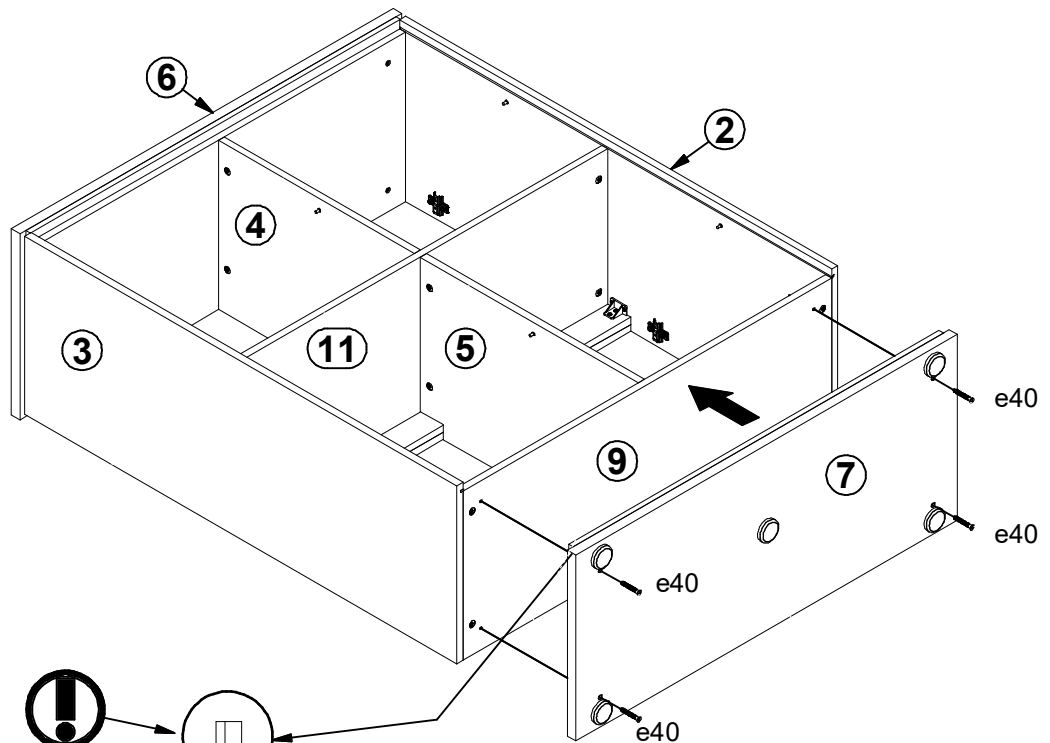

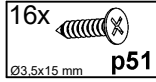
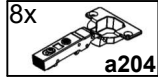

18 ▶

4x !

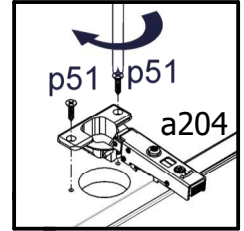
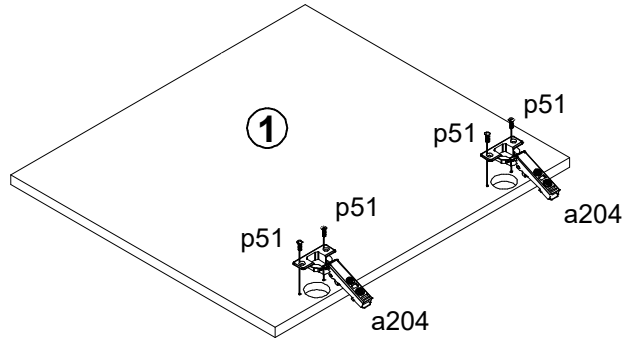

19 ▶

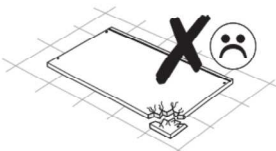
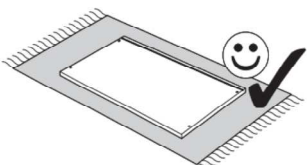
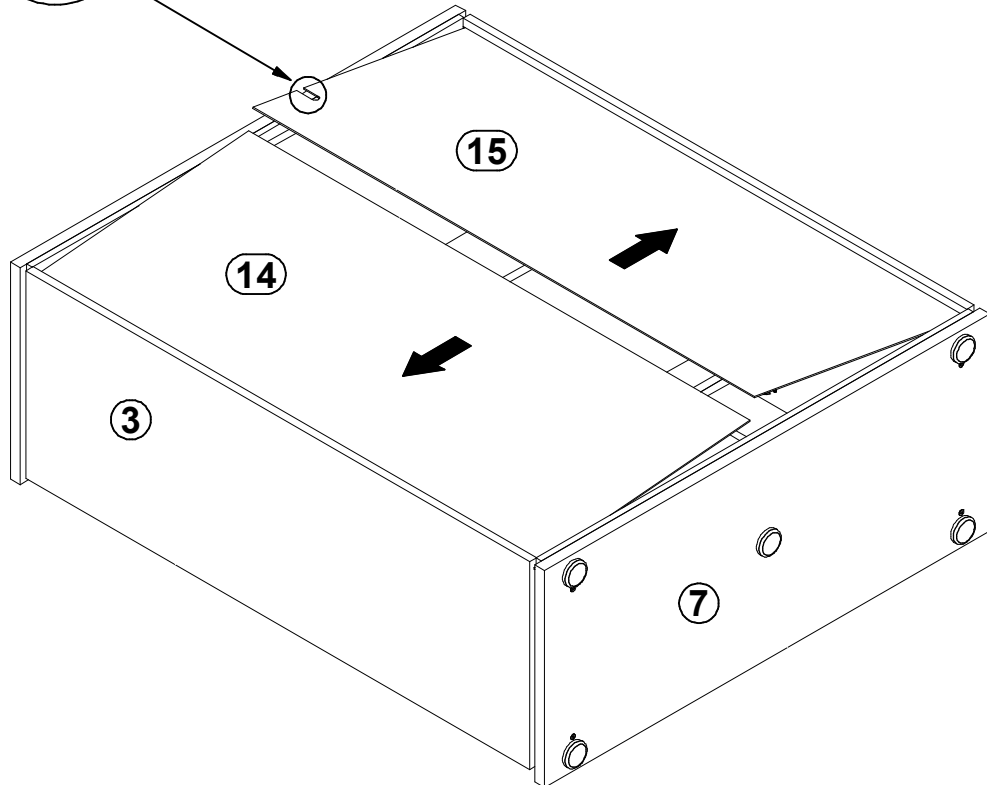
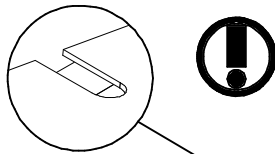

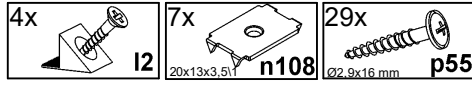

20

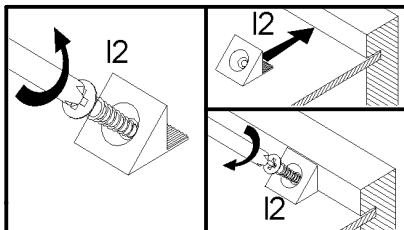
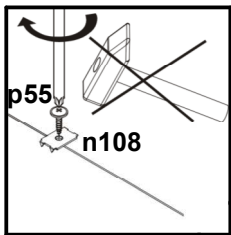
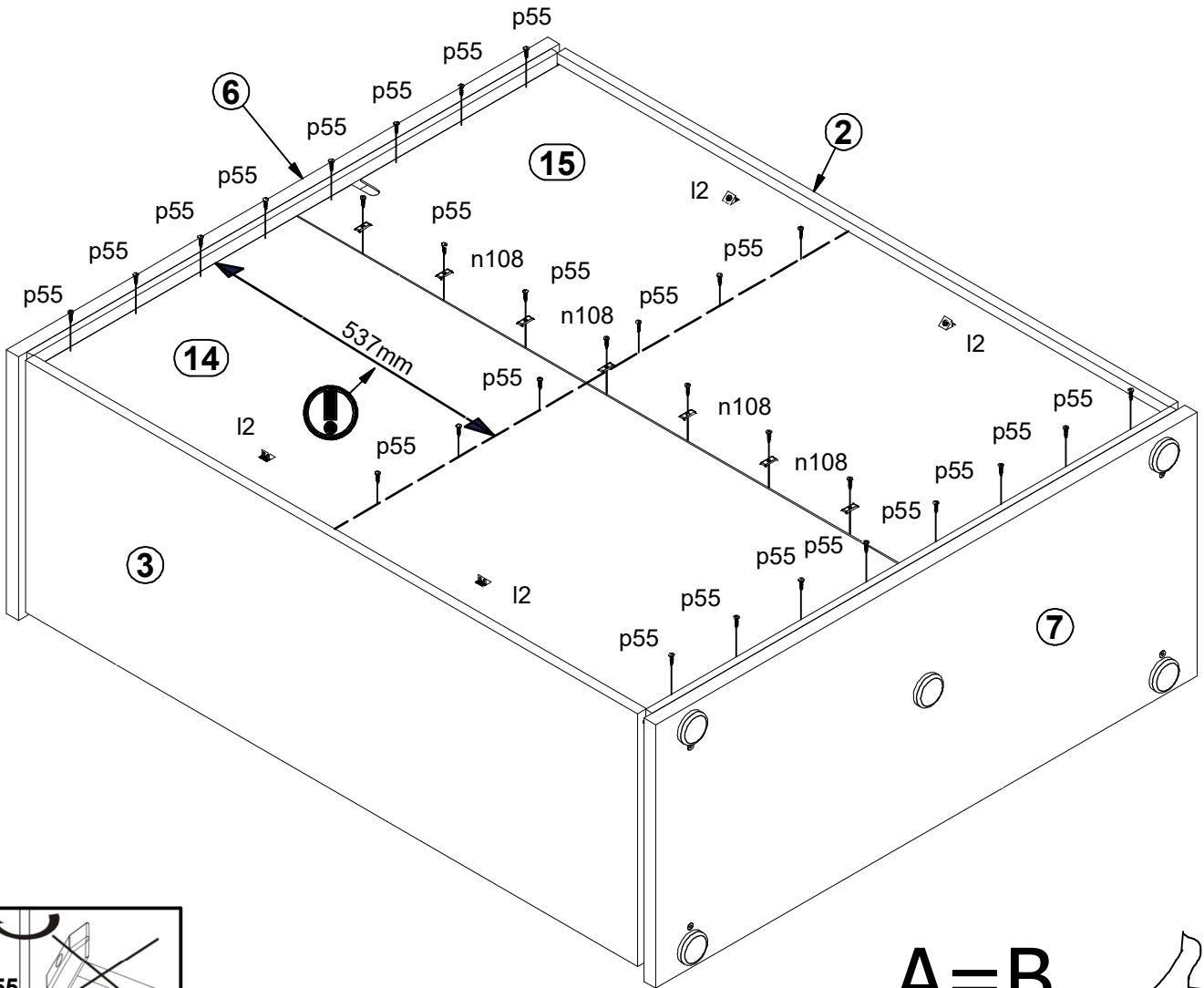
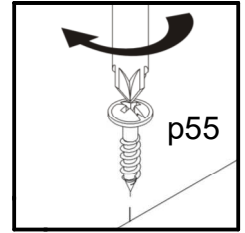

A=B

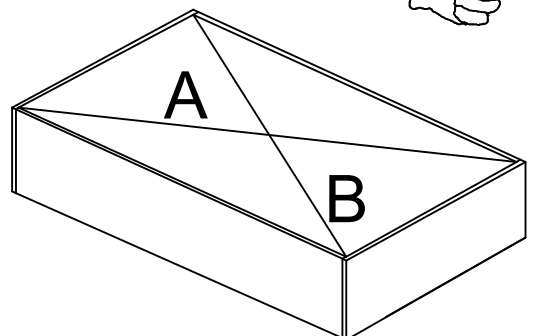

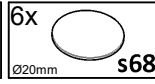
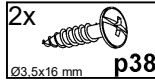
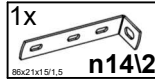

21 ▶

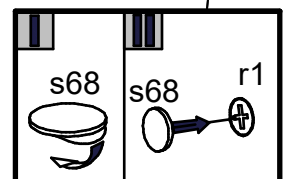
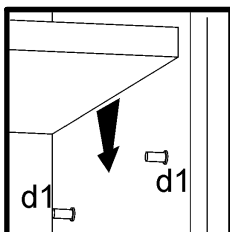
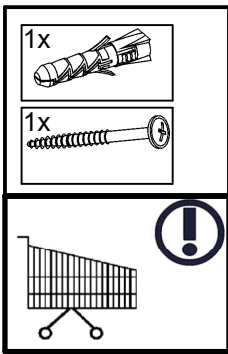
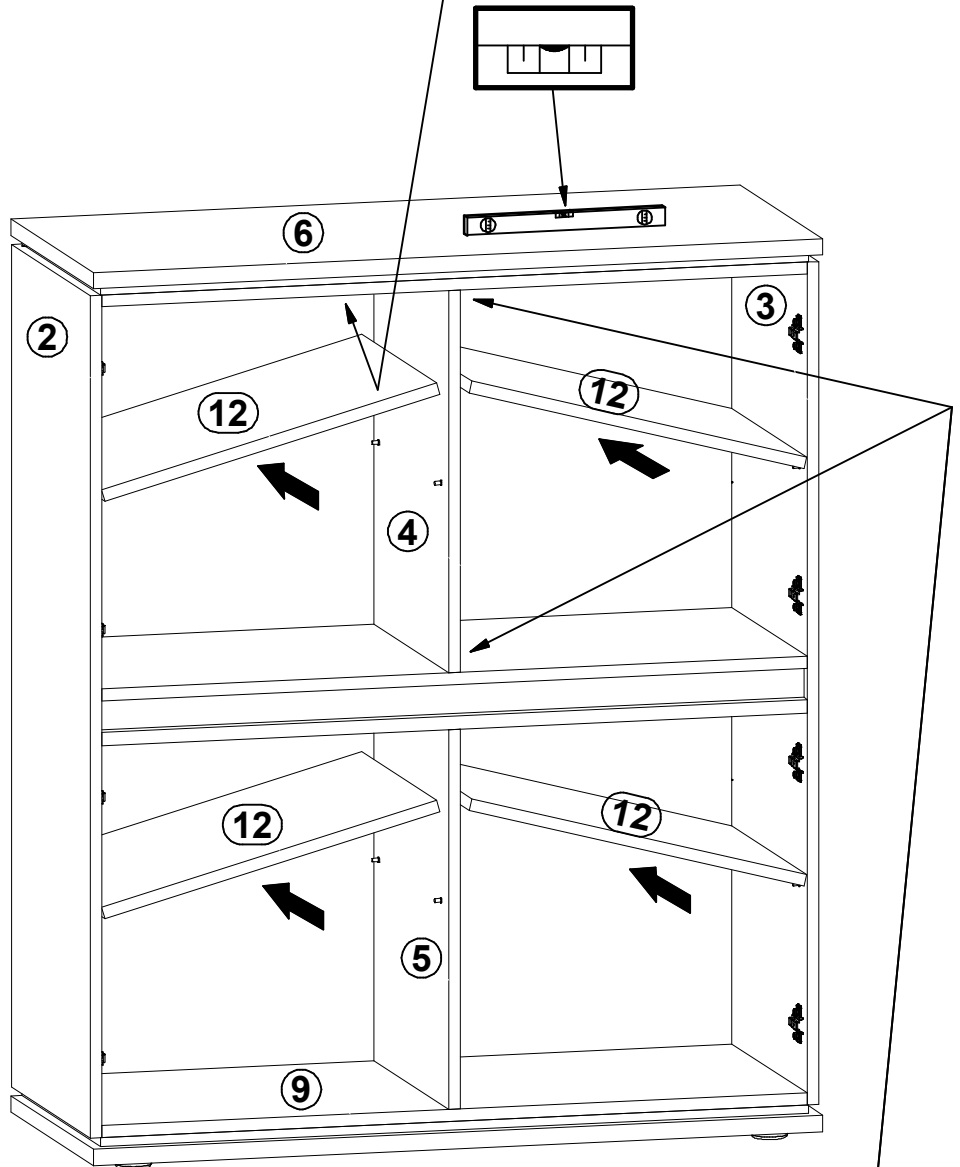
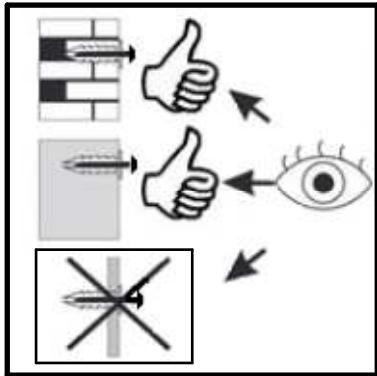
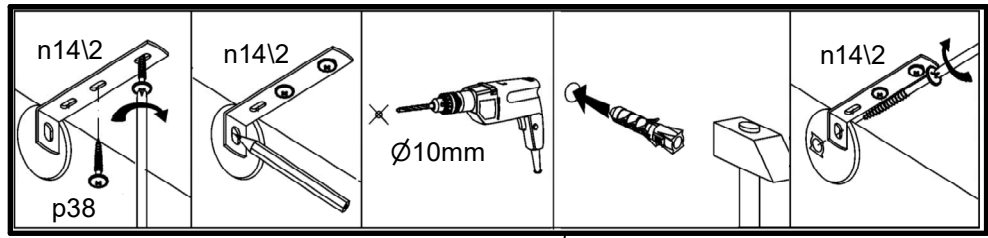



22 ▶

