

A	B	C1	C2	C3	D
1	M262-3008	800	260	22	1/1
2	M262-4501	1508	449	16	1/1
3	M262-4502	1508	449	16	1/1
4	M262-4503	1508	353	19	1/1

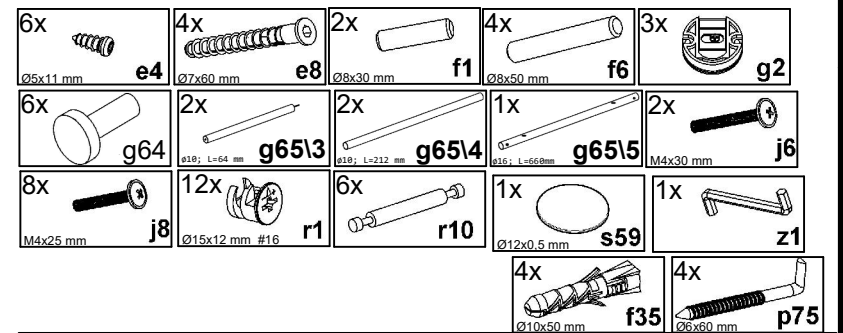

1

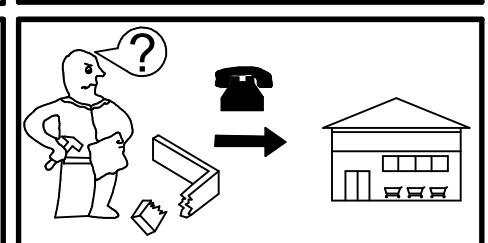
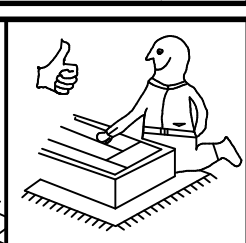
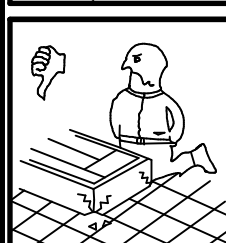
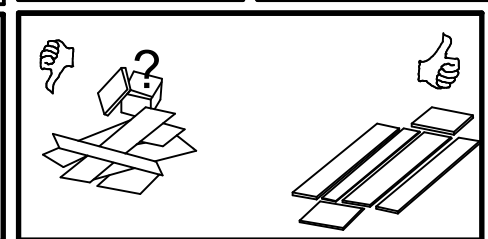
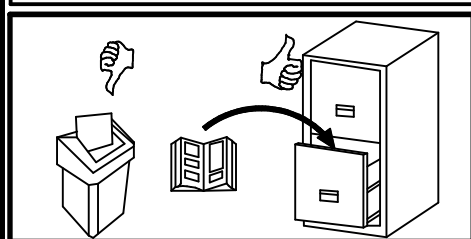
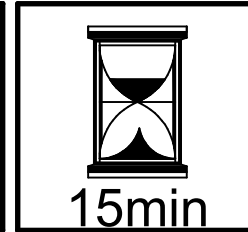
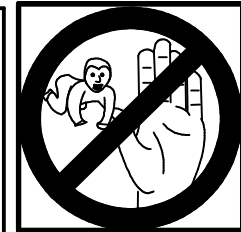
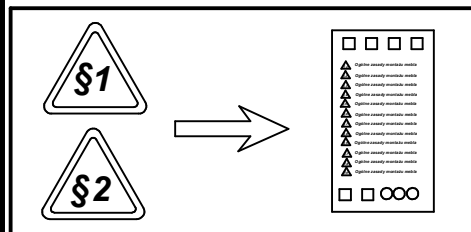
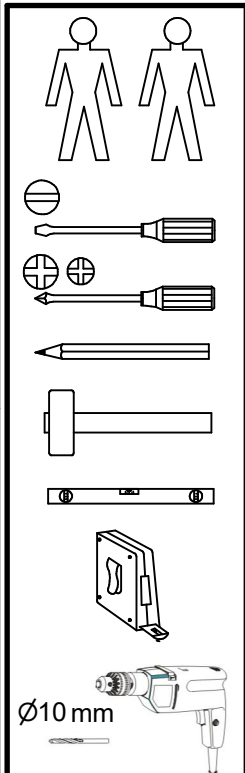
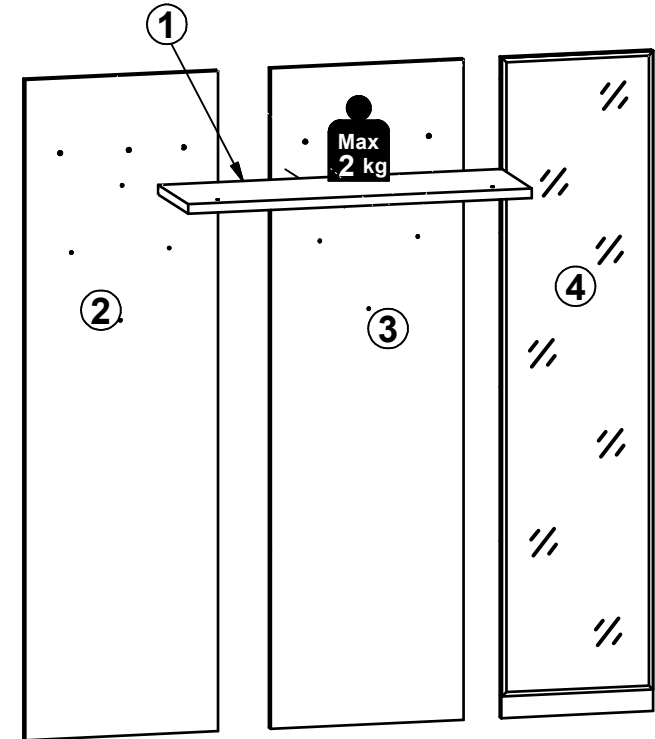
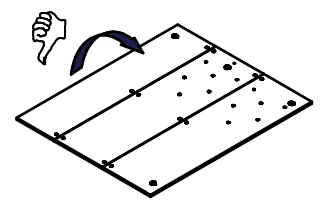
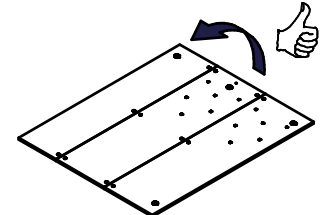
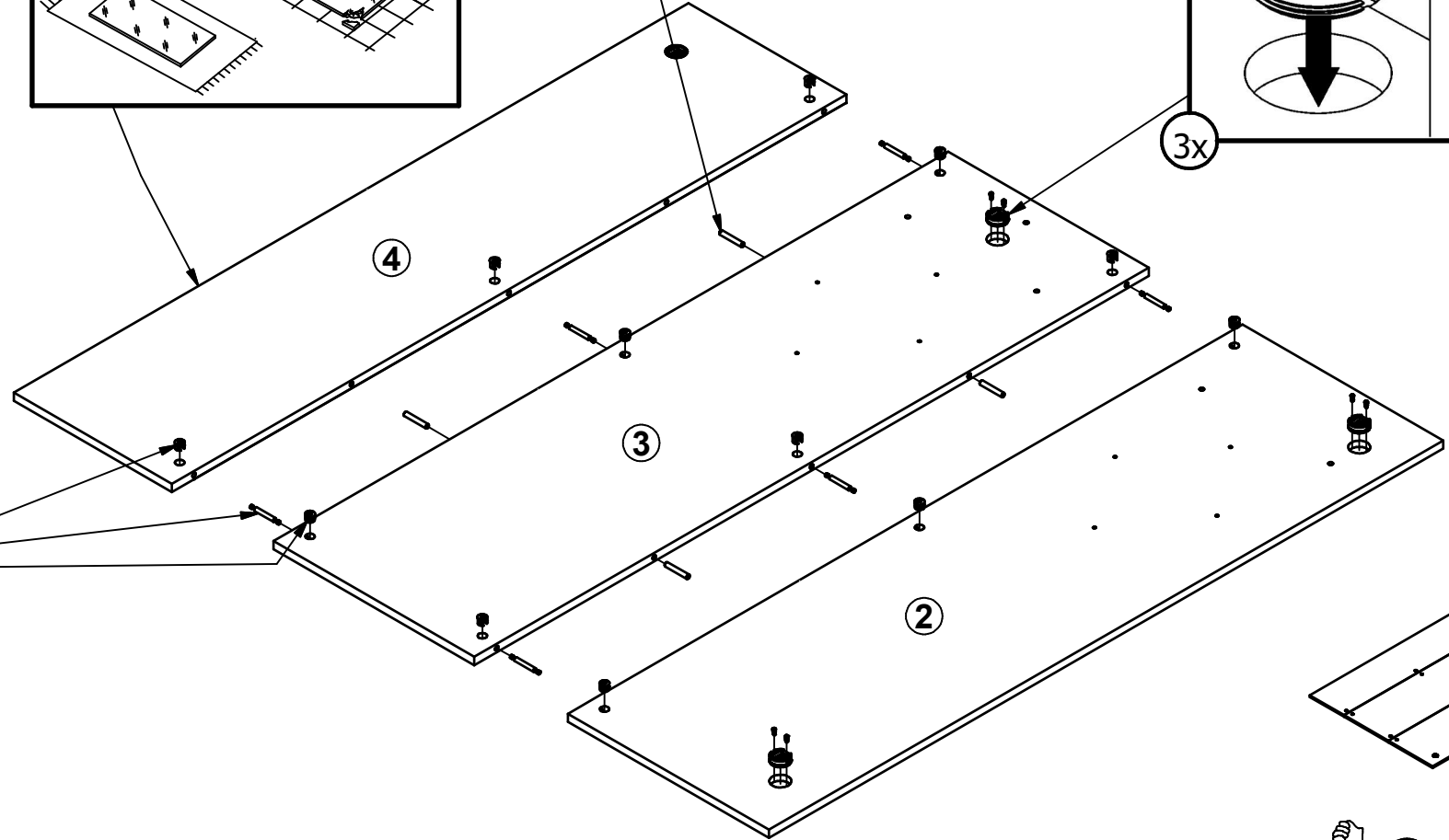
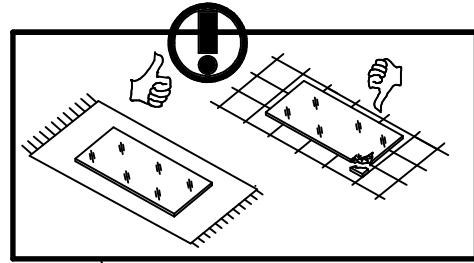
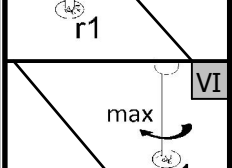
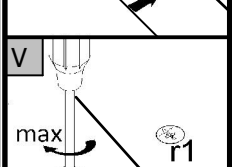
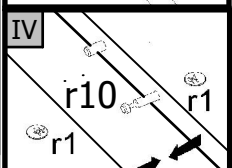
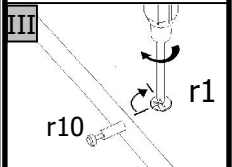
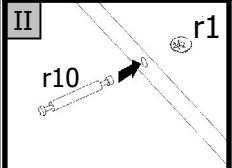
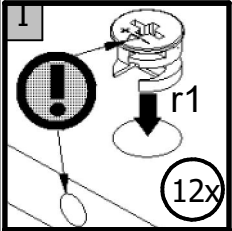
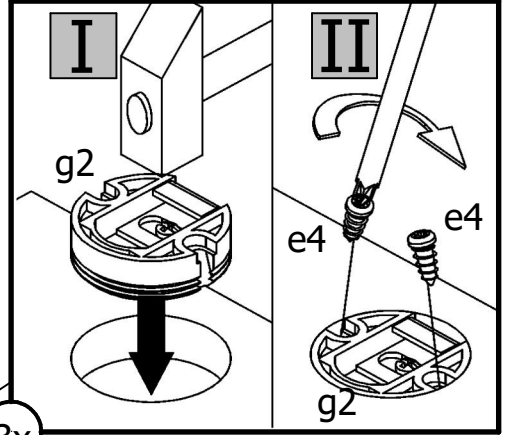
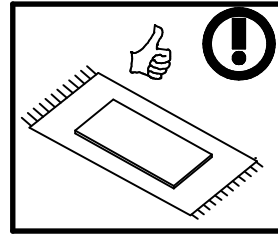
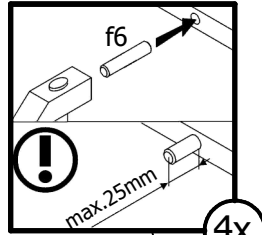

6x

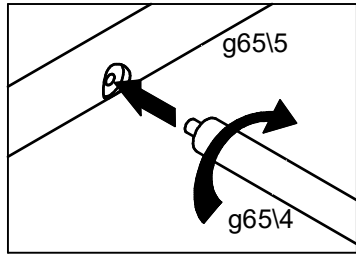
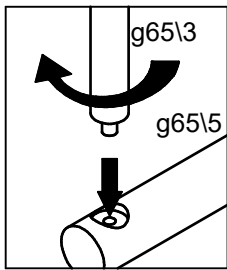

2

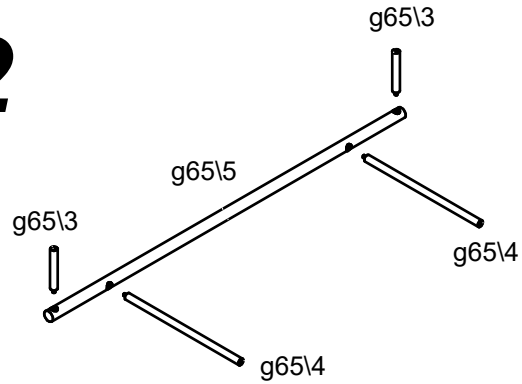

3

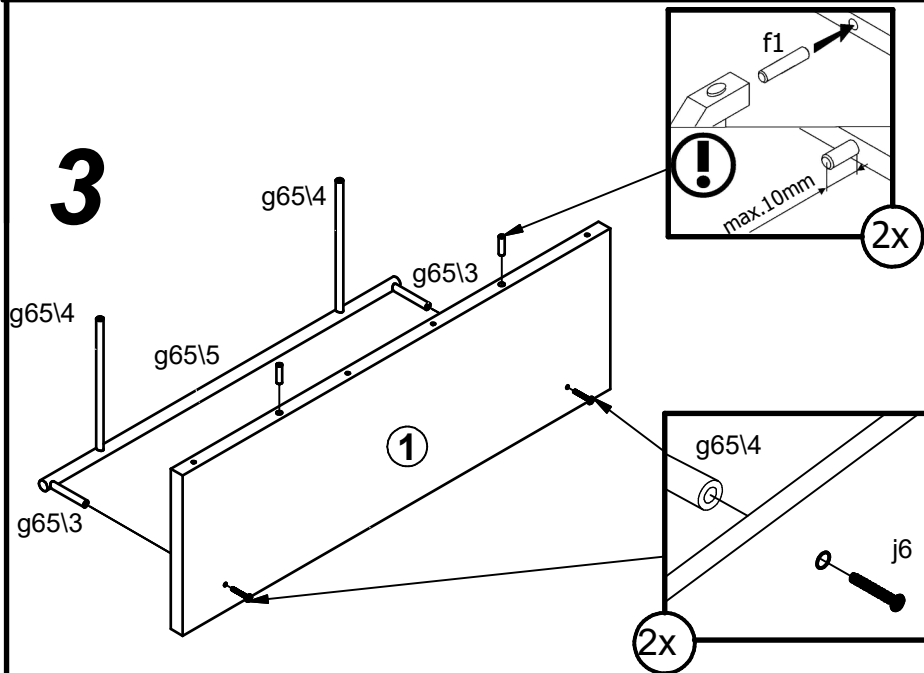

4

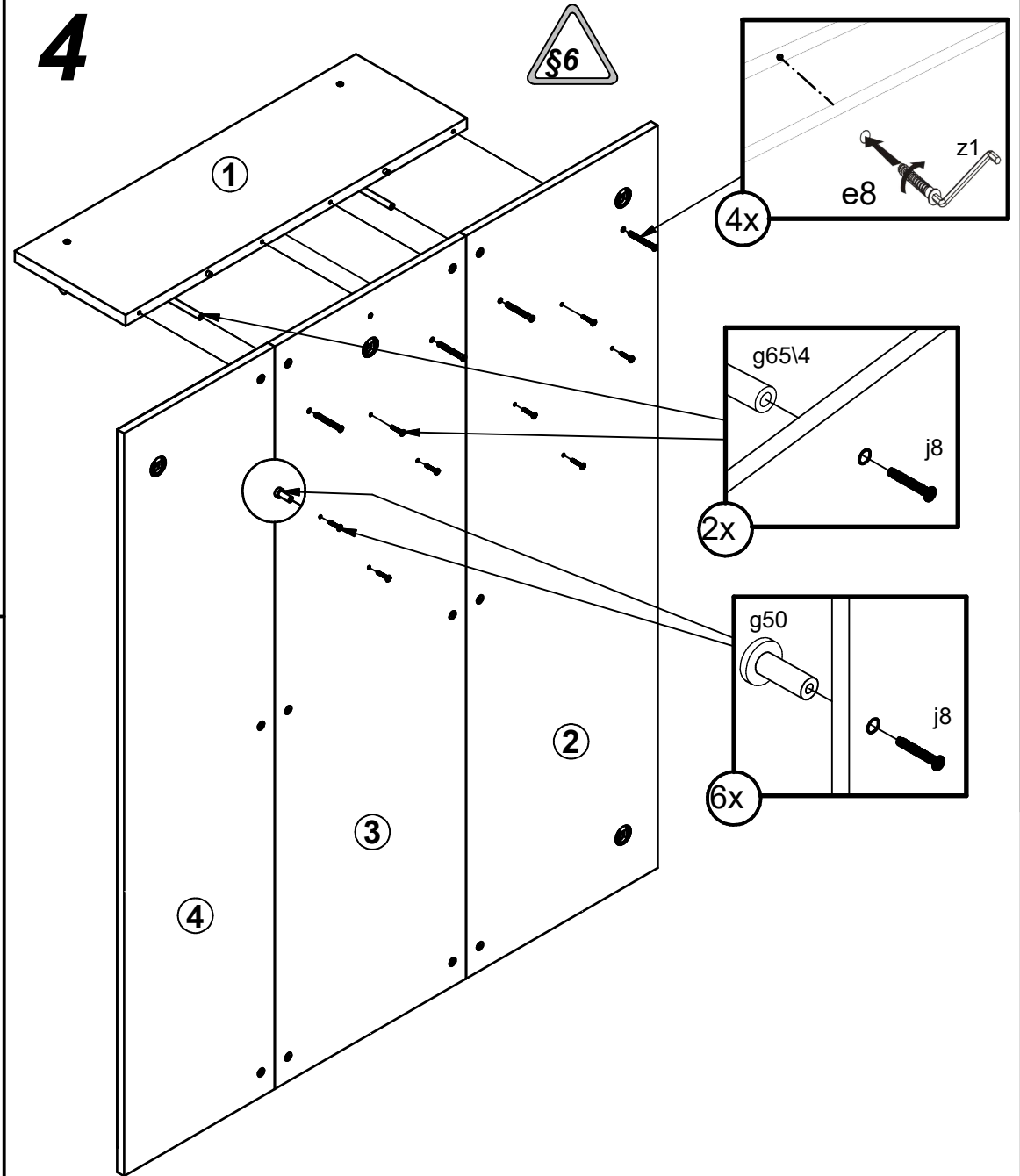

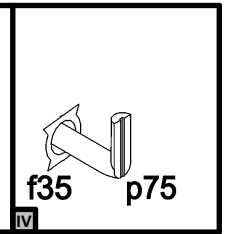
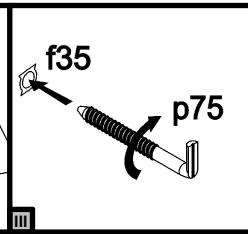
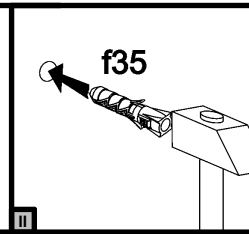
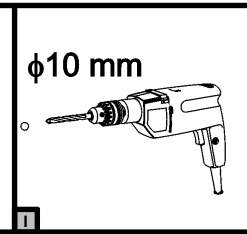
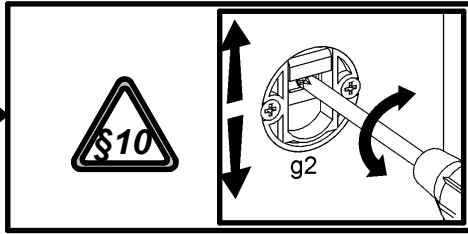
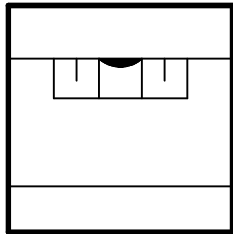

5

