

LKZ 85020

Modellnummer / Number / Numéro du modele  
 Numero / Номер на модела / modello  
 Číslo modelu / Modell száma / Eíslo modelu  
 Številka modela / Număr model / Broj modela  
 Modelnummer / Numer modelu

**X5W ## 703**

Type / Tipo / Típus / Typ / Тип / Tip

**703**

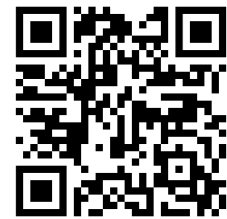
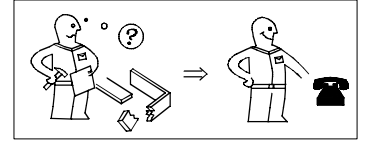
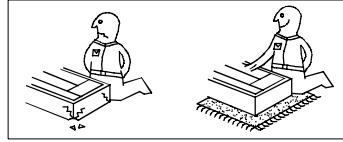
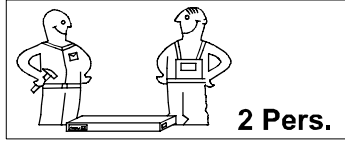
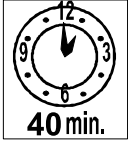

**01.04.2026**

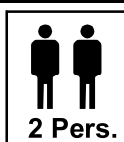
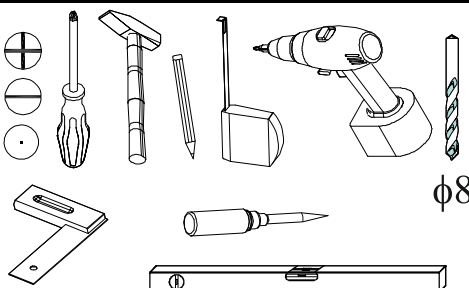
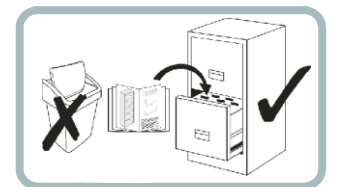

festziehen / tighten / Затягнэть / serrer / stringere / utáhnout / vasttrekken / zategnuti / strángerere / zwiázac / zaciásnac / szorosan meghúzni / pevne dotiahnut' / trdno pritegniti / затянуть / dra ít



eindrücken / press in / enfoncer / wcisnąć / ribattere / zatlačit / Вкарáйте / indrukken / benyomni / stlačít' / vísiniti / tryck in / introducere prin apăsare / вдáвить



ausmessen / measure / mesurer / misurare / opmeten / izméríti / miara / kimémi / izméríti / măsurare / измерить / zméřit / Измерете / mät upp / zmierzyc



drücken / press / presser / stisknout / Натиснете / vísiniti / nasinac / drukken / pritisnuti / nacisnac / pritisniti / нажать / (meg)nyomni / apăsare / tryck fast / nacisnąc



einschlagen / hammer in / bevérni / sla in / frapper au marteau / infossare / Zabit' / zarazit / Набейте / zabiti / wbić / introduce prin bátaie / забить / zatloct



Drehen - wenden / przekręcić - odwrócić / Keren - omdraaien / Girare - Ruotare / Okrenuti - ubrnuti / Retourner - renverser / Turn over - turn around / Otocte - obratite / Závěрте - обьрнете / Obrnite list / Íntoarceți - rotiți / Vrid runt - vänd / прокрутить - повернуть / otočit - obrátit / elforgatni - megfordítani

LKZ 85020

Modellnummer / Number / Numéro du modele  
Numero / Номер на модела / modello  
Číslo modelu / Modell száma / Eíslo modelu  
Številka modela / Număr model / Broj modela  
Modelnummer / Numer modelu

X5W ## 703

Type / Tipo / Típus / Typ / Тип / Tip

703

**D** Unser Direktservice für Beschlagteile  
Sollte Ihnen ein Beschlagteil fehlen, können Sie diese Servicekarte direkt an die untenstehende Adresse mailen. Wir können allerdings nur Beschlagteile auf diesem Wege verschicken. Sollten Sie eine andere Beanstandung an Ihrem Möbelstück haben, so wenden Sie sich bitte direkt an Ihr Möbelhaus.

**GB** Our direct order service for fitting  
If a fitting part is missing, you can e-mail this service card directly to the address below. However, we can only send fitting parts in this way. If you have any other cause for complaint concerning your item of furniture, please contact your furniture store directly.

**CZ** Naše primé služby pro kování  
Chybí-li vám nějaký díl z kování, můžete tuto servisní kartu odeslat e-mailem přímo na níže uvedenou adresu. Touto cestou však můžeme zoslat jen díly kování. Pokud byste reklamovali jiný díl nábytku, obraťte se přímo na svého prodejce nábytku.

**F** Bien etudier la notice de montage  
S'il vous manque une ferrure, veuillez envoyer directement la présente carte service à l'adresse e-mail indiquée ci-dessous. Cependant, ceci nous permet uniquement d'envoyer des ferrures. Pour tout autre type de réclamation concernant votre meuble, veuillez contacter directement votre magasin d'ameublement.

**I** Il nostro servizio diretto per l'ordine della ferramenta  
Qualora Vi dovesse mancare un pezzo di fissaggio, allora Vi preghiamo di inviare questa carta di servizio immediatamente all'indirizzo sottostante. Possiamo inviare i pezzi di fissaggio solamente per mezzo di questo procedimento. Qualora dovete avere qualche altra reclamazione in merito al mobile, allora Vi preghiamo di rivolgerVi direttamente al Vostro Negozio di mobili.

**BG** Нашата директна услуга за обко  
Ако липсват части от комплекта, попълнете настоящата сервисна карта и ни я изпратете на e-mail адреса, посочен по-долу. По този начин можем да доставяме само липсващи елементи от обко. Ако установите други дефекти по мебелите, Ви съветваме да се обрънете към мебелната къща/магазин, от който сте закупили стоката.

**NL** Onze directservice voor losse onderdelen  
Wanneer er een onderdeel ontbreekt, kunt u deze servicekaart direct aan onderstaand e-mailadres sturen. Wij kunnen langs deze weg echter alleen beslagdelen versturen. Mocht u een ander probleem aan uw meubel hebben, verzoeken wij u contact op te nemen met uw meubeldealer.

**PL** Nasz bezposredni serwis czesci montazowych  
Jeżeli brakuje części koniecznych do montażu, prosimy o przesłanie nam niniejszej karty serwisowej na niżej podany adres e-mailowy. W ten sposób możemy przesyłać Państwu tylko brakujące części. W przypadku innych reklamacji dotyczących mebla, prosimy zgłosić się do salonu meblowego, w którym został dokonany zakup.

**HR** Servis za okove  
U slučaju da nedostaje neki od dijelova molimo vas da na dolje navedenu mail adresu pošaljete ovaj servisni obrazac. Na ovaj način mogu se dostaviti samo okovi. U slučaju da imate dodatne prigovore vezane uz komad namještaja molimo vas da se obratite izravno trgovini namještaja gdje je isti kupljen.

**HU** Direktszolgálatunk vasalatók esetén  
Ha hiányzik egy vasalató, ezt a kártyát közvetlenül elküldheti az alább található címre. Azonban csakis vasalatókat tudunk így küldeni. Amennyiben másfajta reklamáció áll fenn bitórदारabját illetően, forduljon közvetlenül a bitórházhoz.

**SK** Náš priamy servis pre časti kovania  
Ak by Vám chýbala nejaká časť kovania, môžete poslať túto servisnú kartu poslať e-mailom na nižšie uvedené adresu. Diely kovania vieme poslať iba týmto spôsobom. Ak by ste mali inú reklamáciu ohľadom Vášho nábytku, obráťte sa priamo na Vašu predajňu nábytku.

**SLO** Naše direktne uslužne storitve za okovje  
Če vam manjka kakšno okovje, lahko to servisno kartico pošljete po e-pošti direktno na spodnji naslov. Po tej poti vam lahko pošljemo samo okovje. Če želite reklamirati kakšen drug del pohištva, se obrnite neposredno na vašo trgovino pohištva.

**RO** Service-ul nostru direct pentru feronerie  
In cazul în care vă lipsește o piesă de feronerie puteți să trimiteți direct acest card de service prin e-mail la adresa de mai jos. Noi nu putem expedia piese de feronerie decât pe această cale. Dacă aveți o altă reclamație referitoare la piesa de mobilier, atunci vă rugăm să vă adresați direct la magazinul dvs. de mobilă.

**RUS** Наш прямой сервис для поставок фурнитуры  
Если окажется, что Вам не хватает того или иного элемента фурнитуры, Вы можете отправить сервисную карту по факсу непосредственно на нижеприведенный адрес электронной почты. Однако, таким образом мы можем пересылать лишь фурнитуру. Если же у Вас возникнут иные претензии относительно приобретенной мебели, пожалуйста, обращайтесь непосредственно в организацию, осуществившую продажу.

**S** Vår direktservice för beslagsdelar  
Om du saknar en beslagsdel kan du skicka detta servicekort direkt till e-postadressen som anges nedan. Tänk på att detta är den enda möjligheten att skicka beslagsdelar till dig. Om du vill reklamera din möbel av en annan anledning måste du kontakta ditt möbelhus direkt.

**ES** Nuestro servicio directo para accesorios  
Si le falta algún accesorio, puede enviar esta tarjeta de servicio directamente a la siguiente dirección. No obstante, por este método solo podemos enviar accesorios. Si tiene alguna otra objeción sobre su mueble, consulte directamente con su mueblería.

**TR** Donatılar için doğrudan servisimiz  
Bir donatılar eksikse bu servis kartını doğrudan aşağıda bulunan adrese doğrudan mail yazabilirsiniz. Sadece bu yolla donatılar gönderiliriz. Mobilyanızda başka şikayetleriniz varsa lütfen doğrudan mobilya satıcınıza danışın.

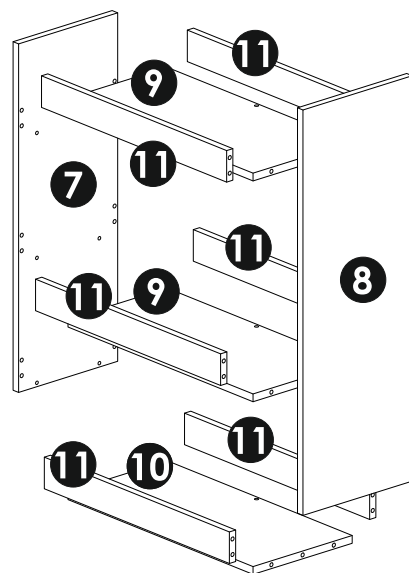
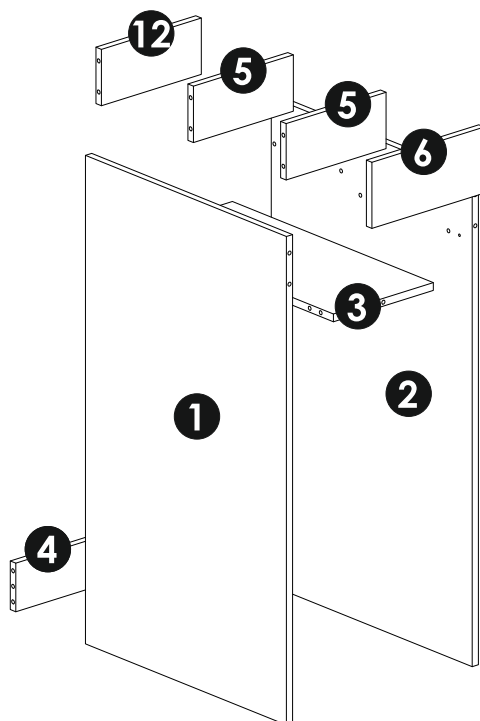
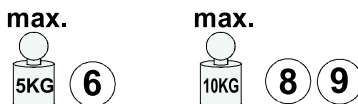

| Nr | Maße mm     | Colli | Anzahl |
|----|-------------|-------|--------|
| 1  | 1005 584 16 | 1/1   | 1      |
| 2  | 1005 584 16 | 1/1   | 1      |
| 3  | 256 584 16  | 1/1   | 1      |
| 4  | 256 100 16  | 1/1   | 1      |
| 5  | 256 116 16  | 1/1   | 2      |
| 6  | 288 136 16  | 1/1   | 1      |
| 7  | 717 254 16  | 1/1   | 1      |
| 8  | 834 280 16  | 1/1   | 1      |
| 9  | 538 254 16  | 1/1   | 2      |

| Nr | Maße mm    | Colli | Anzahl |
|----|------------|-------|--------|
| 10 | 538 254 16 | 1/1   | 1      |
| 11 | 538 65 16  | 1/1   | 6      |
| 12 | 256 116 16 | 1/1   | 1      |
| B* |            | 1/1   | 1      |

Grund der Beanstandung / Reason of the objection:

Möbelhaus / Furniture store:

Name / Nom:

Telefon / Telephone:

PLZ / Bank sorting code:

Ort / City:

Strasse / Street:

Haus-Nr. / House No.:

@E-Mail:

LKZ 85020

Modellnummer / Number / Numéro du modèle  
Numero / Номер на модела / modello  
Číslo modelu / Modell száma / Eíslo modelu  
Številka modela / Număr model / Broj modela  
Modelnummer / Numer modelu

**X5W ## 703**

Туре / Типо / Тípus / Тур / Тип / Тíп

**703**

B1

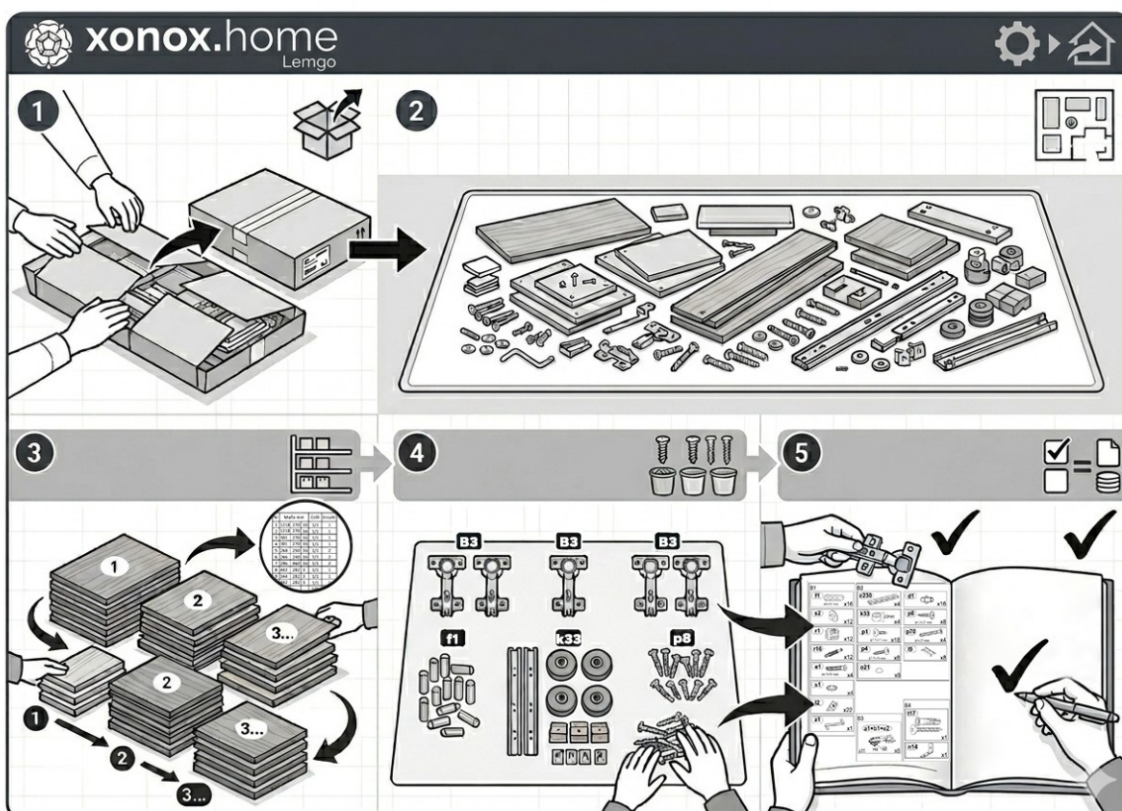
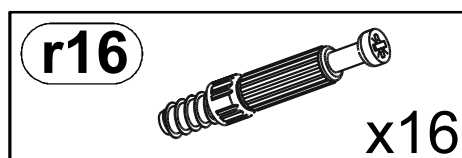
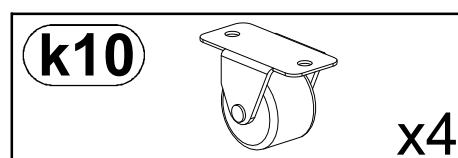
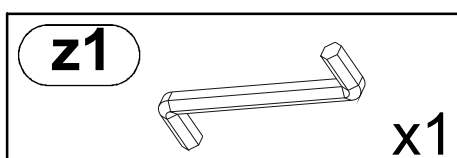
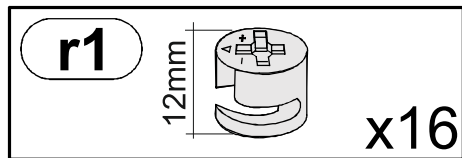
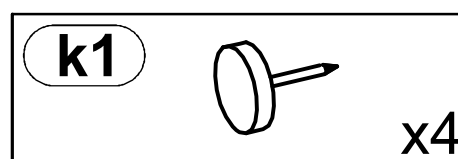
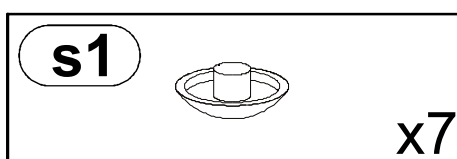
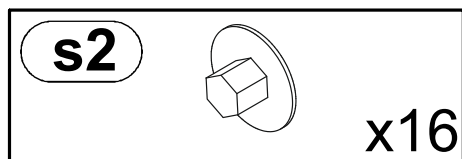
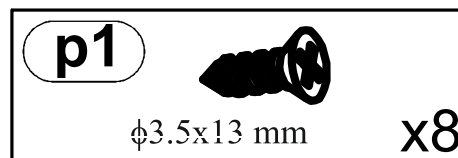
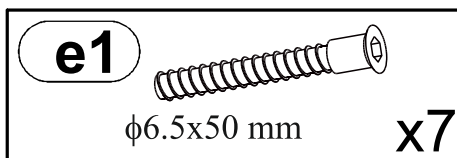
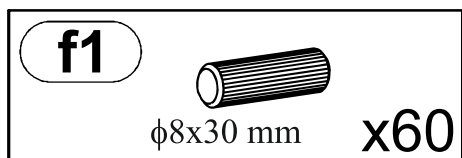



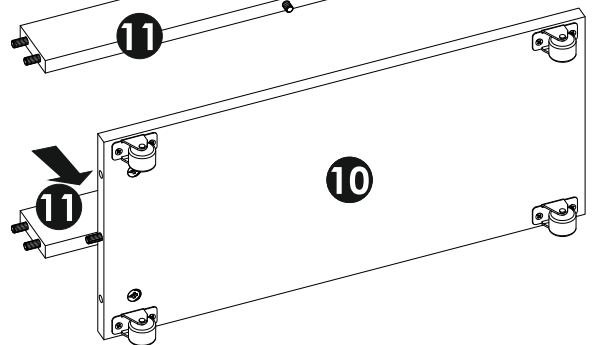
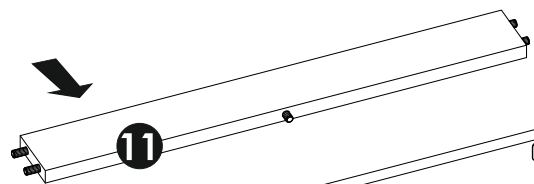
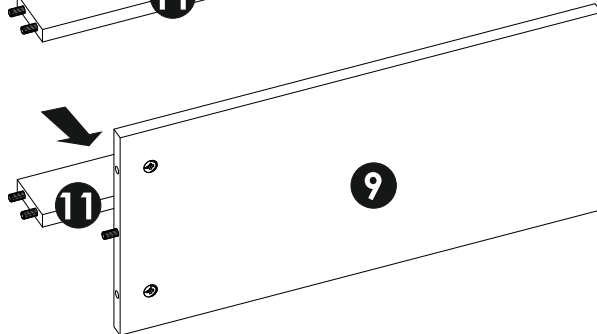
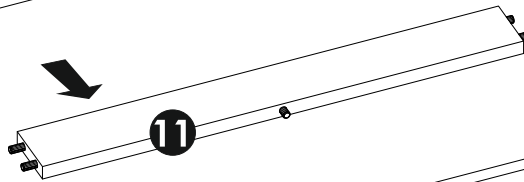
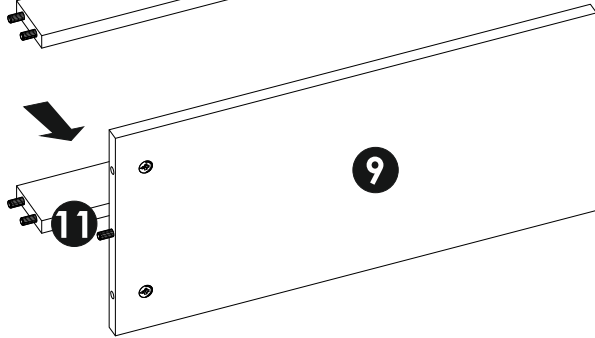
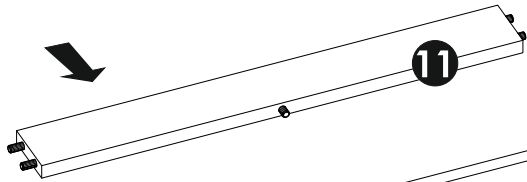
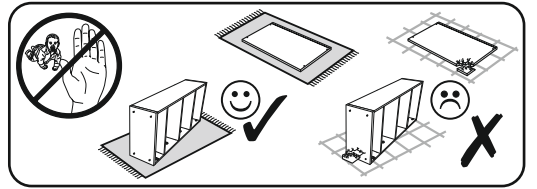

3



φ6.5x50 mm x6

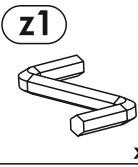

x1

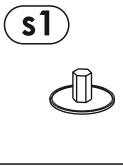

x6

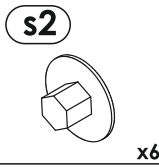

x6

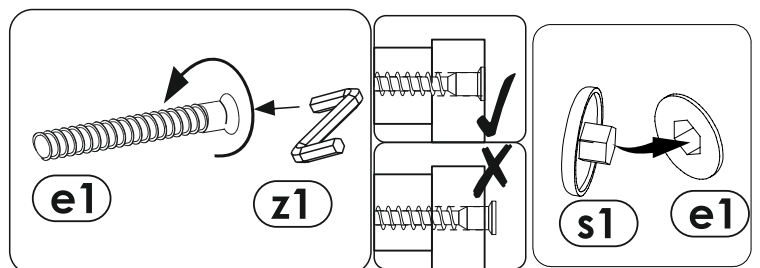
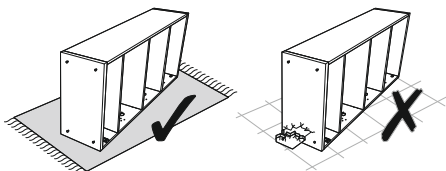
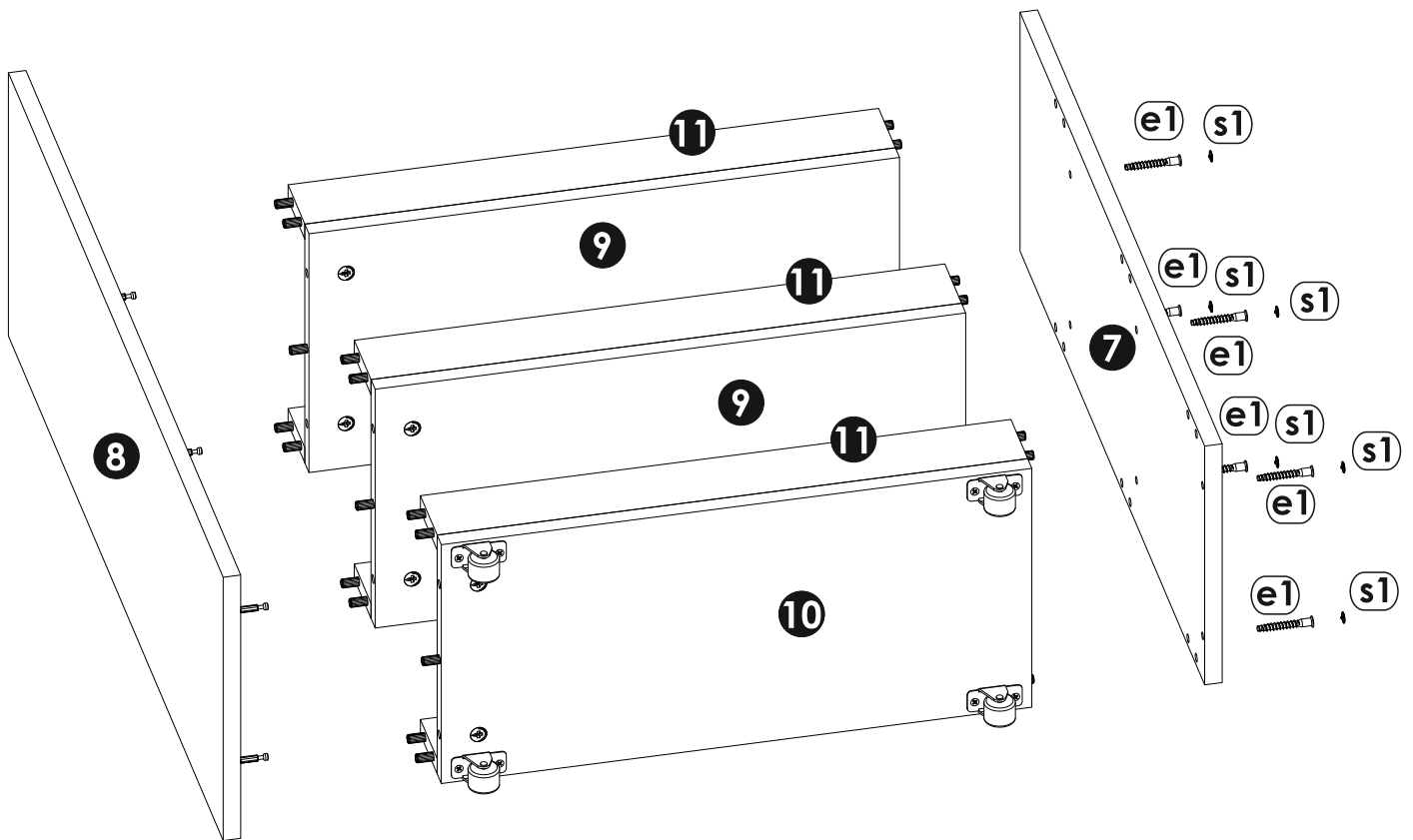
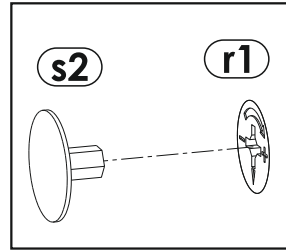
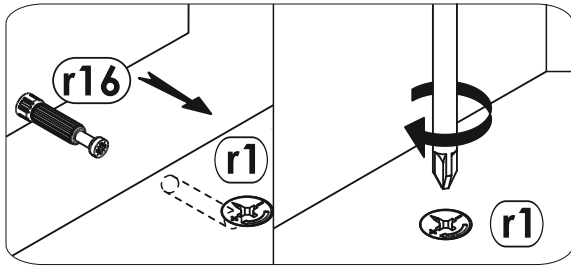
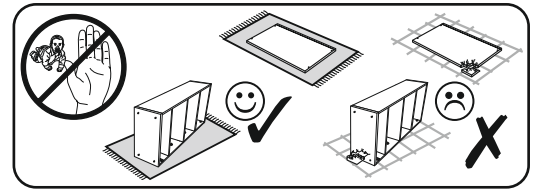

4

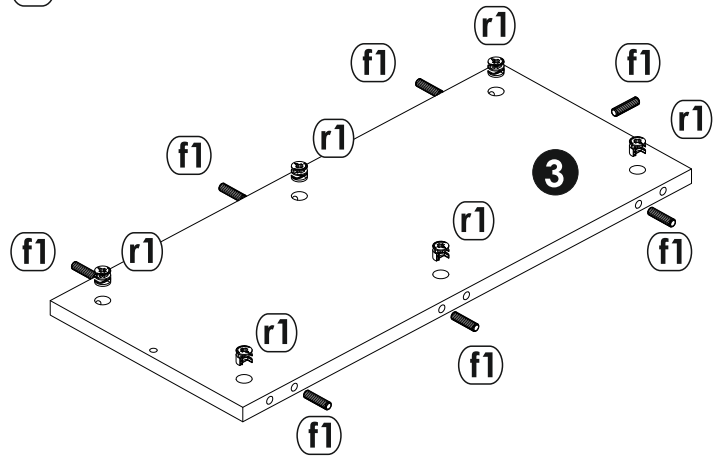
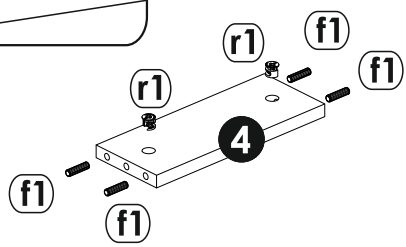
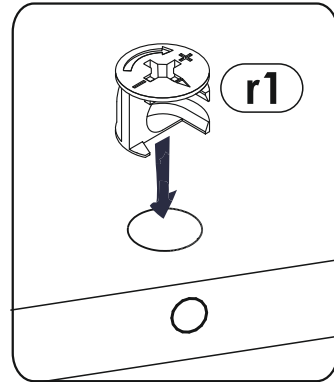
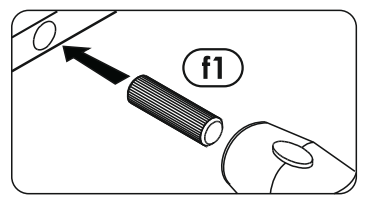
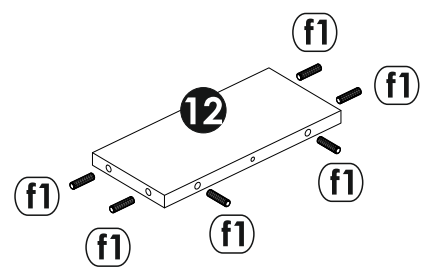
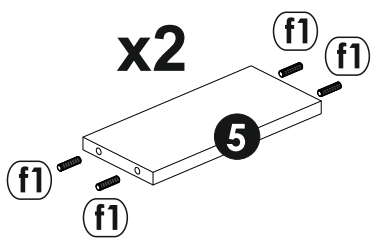
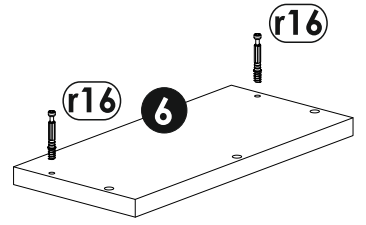
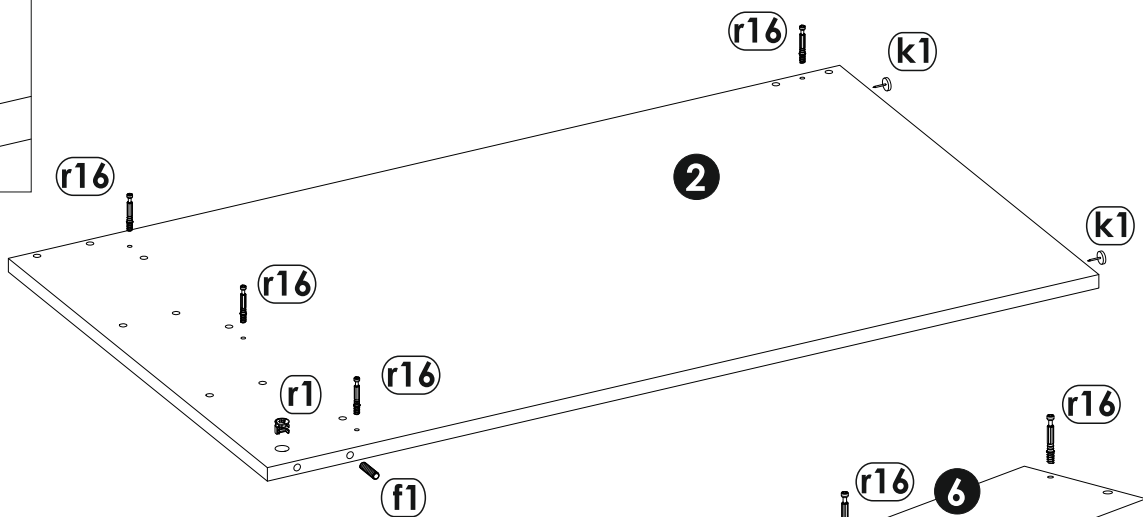
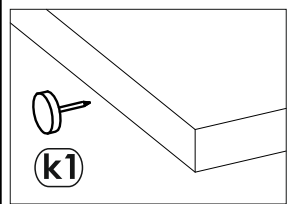
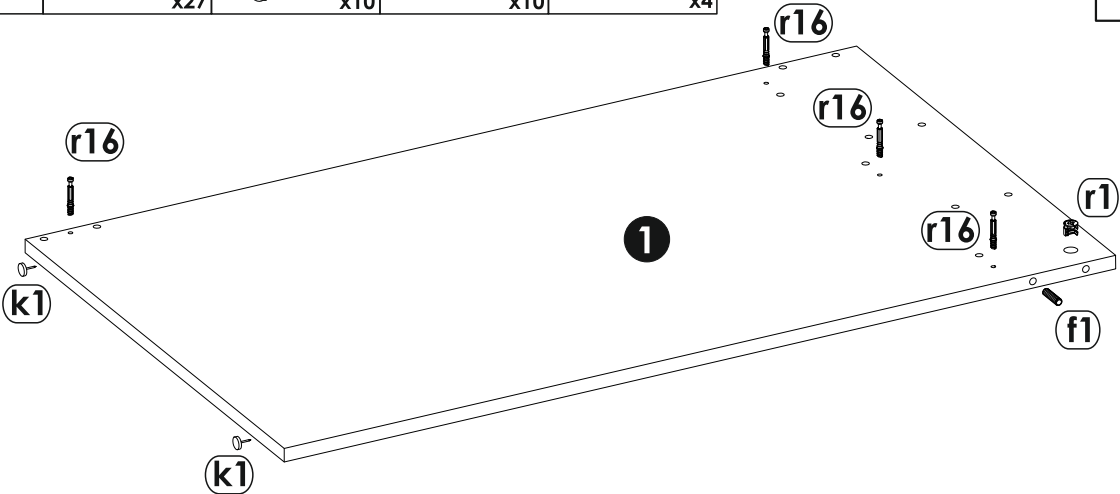
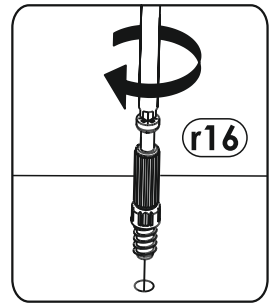
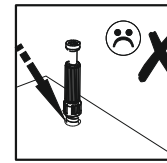
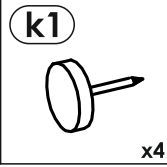
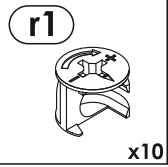
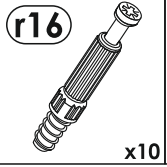
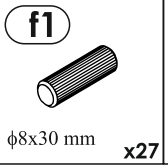

5

e1



φ6.5x50 mm x1

z1

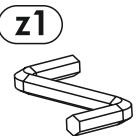

x1

s1

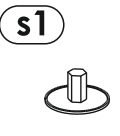

x1

s2

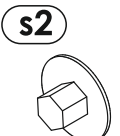

x8

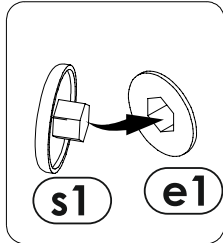

s1

e1

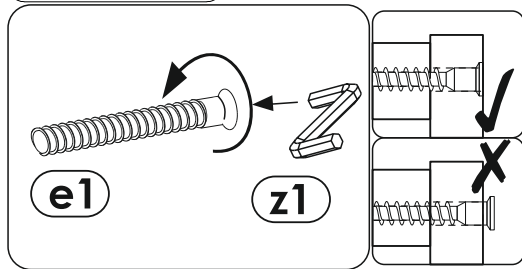

e1

z1

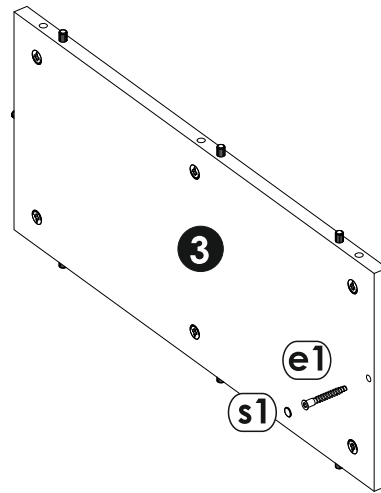

3

e1

s1



12

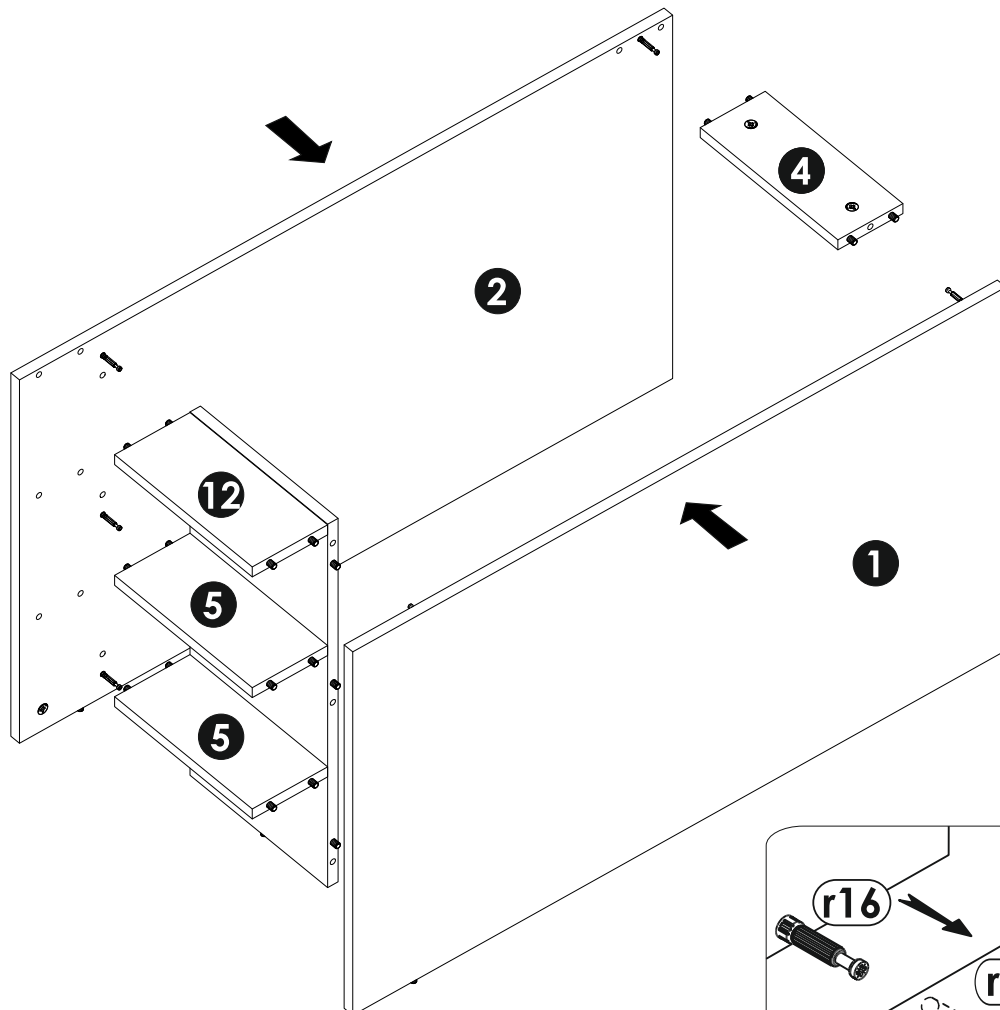

2

4

12

5

5

1

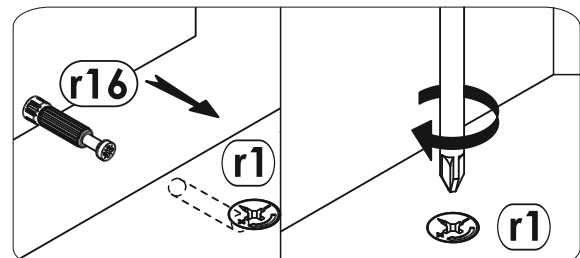

r16

r1

r1

6

s2



x2

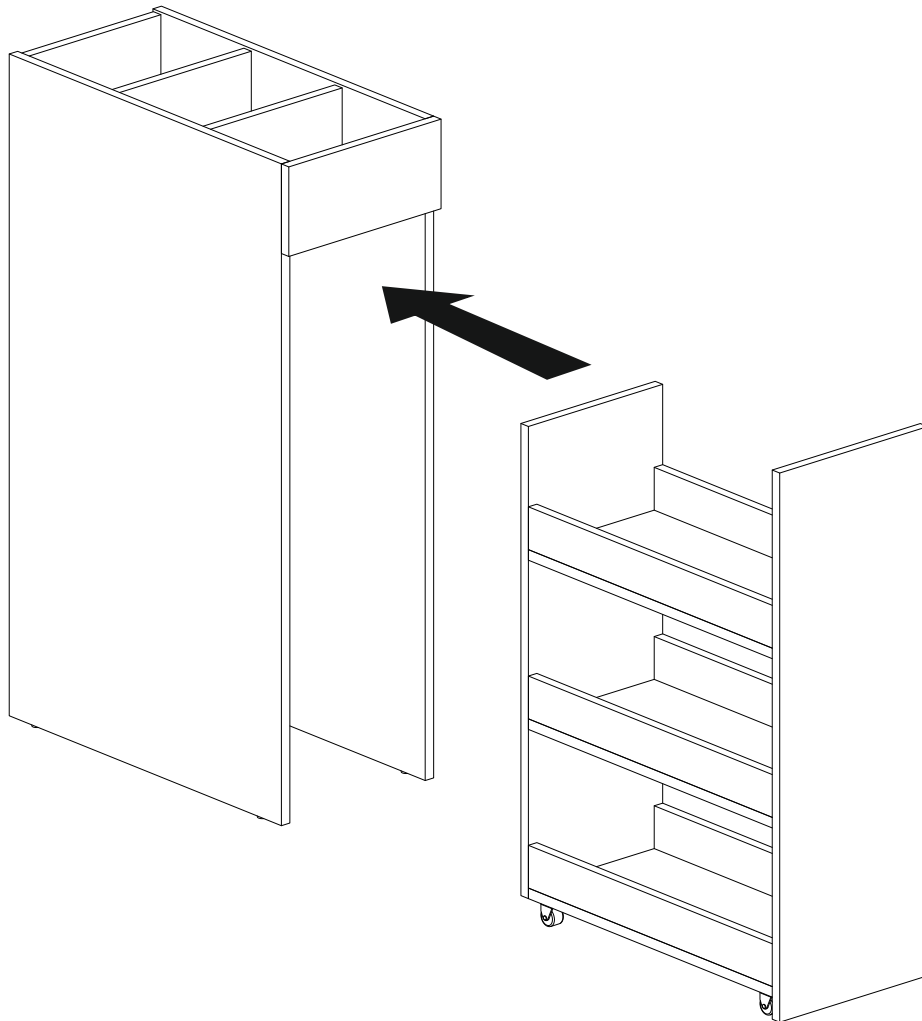
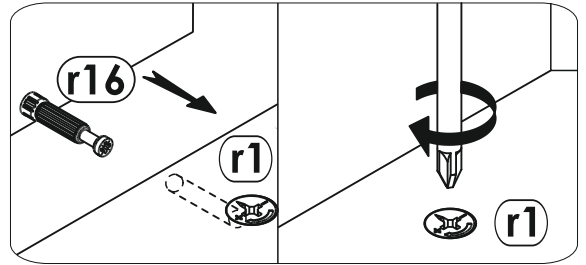
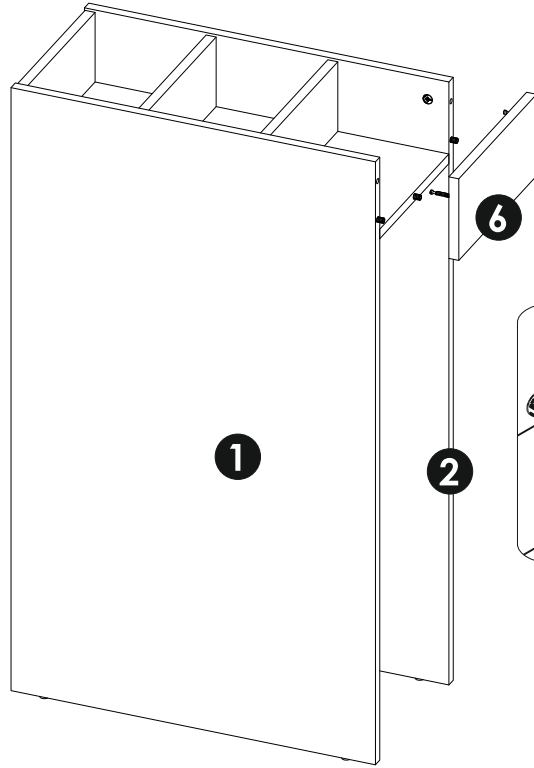

LKZ 85020

Modellnummer / Number / Numéro du modele  
 Numero / Номер на модела / modello  
 Číslo modelu / Modell száma / Eíslo modelu  
 Številka modela / Număr model / Broj modela  
 Modelnummer / Numer modelu

**X5W ## 731**

Type / Tipo / Típus / Typ / Тип / Tip

**731**

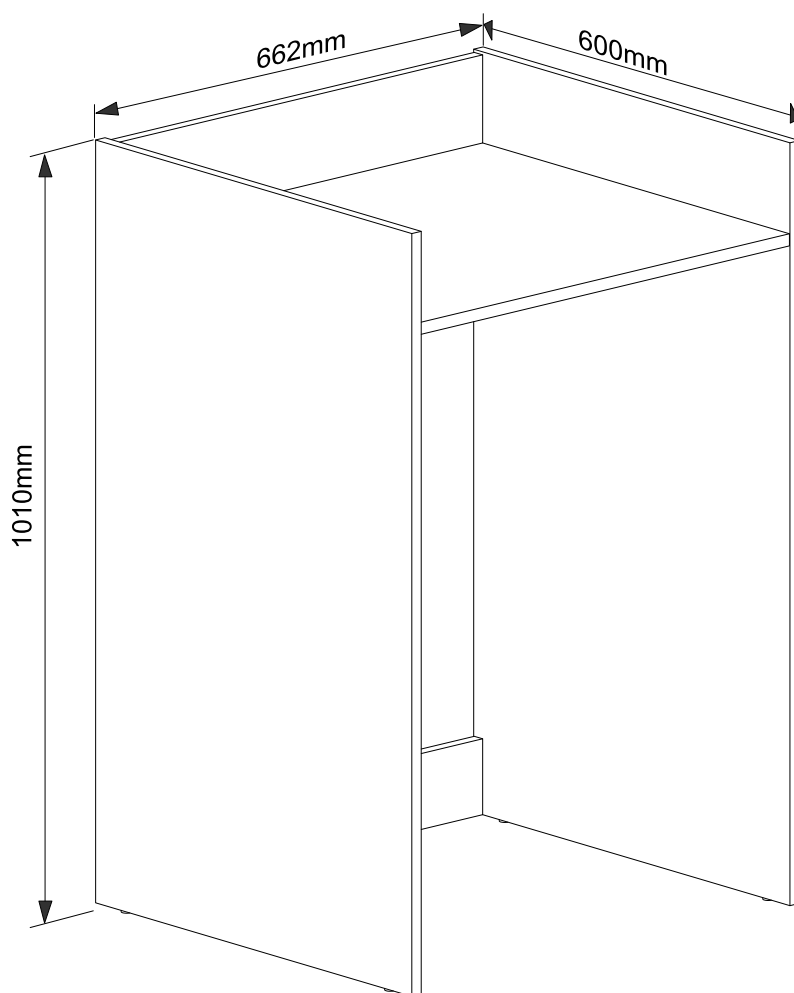
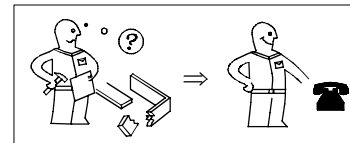
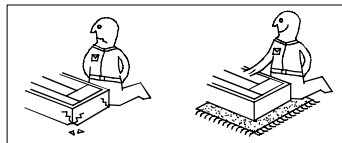
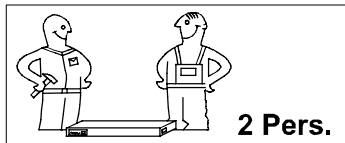
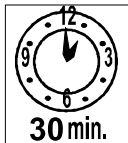
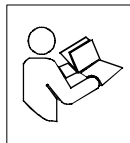

**01.04.2026**

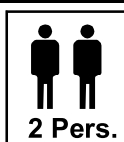
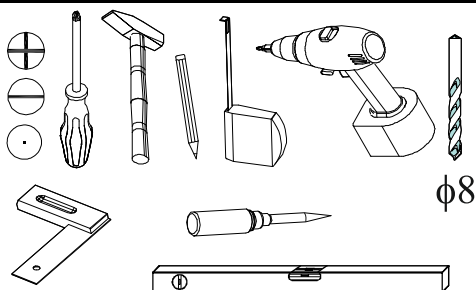
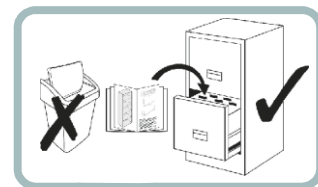

festziehen / tighten / Затягнэть /  
 serrer / stringere / utáhnout / vasttrekken /  
 zategnuti / strángere / zwiázac / zaciásnac /  
 szorosan meghúzni / pevne dotiahnut' /  
 trdno pritegniti / затянуть / dra ít



eindrücken / press in / enfoncer / wcisnac /  
 ribattere / zatlačit / Вкарайте / indrukken /  
 benyomni / stlačit' / vísiniti / tryck in /  
 introducere prin apăsare / вдвэить



ausmessen / measure / mesurer /  
 misurare / opmeten / izmeriti / miara /  
 kiméri / izméríti / mäsurare / измерить /  
 zméřit / Измерете / mät upp / zmierzyc



drücken / press / presser / stisknout /  
 Натиснете / vísiniti / nasinac / drukken /  
 pritisnuti / nacisnac / pritisniti / нажать /  
 (meg)nyomni / apăsare / tryck fast / nacisnac



einschlagen / hammer in / bevérni / sla in /  
 frapper au marteau / infossare / Zabit' /  
 zarazit / Набэйте / zabiti / wbić /  
 introducere prin bátaie / забить / zatloct



Drehen - wenden / przekrećić - odwrócić /  
 Keren - omdraaien / Girare - Ruotare /  
 Okrenuti - ubrnuti / Retourner - renverser /  
 Turn over - turn around / Otocte - obratit'e /  
 Zавэртете - обэртете / Obrnite list /  
 Íntoarceți - rotíți / Vrid runt - vánd /  
 прокрутит'e - повернут'e / otočit' - obrátit'  
 elforgatni - megfordítani

LKZ 85020

Modellnummer / Number / Numéro du modele  
Numero / Номер на модела / modello  
Číslo modelu / Modell száma / Eíslo modelu  
Številka modela / Număr model / Broj modela  
Modelnummer / Numer modelu

**X5W ## 731**

Type / Tipo / Típus / Typ / Тип / Tip

**731**

**D** Unser Direktservice für Beschlagteile  
Sollte Ihnen ein Beschlagteil fehlen, können Sie diese Servicekarte direkt an die untenstehende Adresse mailen. Wir können allerdings nur Beschlagteile auf diesem Wege verschicken. Sollten Sie eine andere Beanstandung an Ihrem Möbelstück haben, so wenden Sie sich bitte direkt an Ihr Möbelhaus.

**GB** Our direct order service for fitting  
If a fitting part is missing, you can e-mail this service card directly to the address below. However, we can only send fitting parts in this way. If you have any other cause for complaint concerning your item of furniture, please contact your furniture store directly.

**CZ** Naše primé služby pro kování  
Chybí-li vám nějaký díl z kování, můžete tuto servisní kartu odeslat e-mailem přímo na níže uvedenou adresu. Touto cestou však můžeme zoslat jen díly kování. Pokud byste reklamovali jiný díl nábytku, obraťte se přímo na svého prodejce nábytku.

**F** Bien etudier la notice de montage  
S'il vous manque une ferrure, veuillez envoyer directement la présente carte service à l'adresse e-mail indiquée ci-dessous. Cependant, ceci nous permet uniquement d'envoyer des ferrures. Pour tout autre type de réclamation concernant votre meuble, veuillez contacter directement votre magasin d'ameublement.

**I** Il nostro servizio diretto per l'ordine della ferramenta  
Qualora Vi dovesse mancare un pezzo di fissaggio, allora Vi preghiamo di inviare questa carta di servizio immediatamente all'indirizzo sottostante. Possiamo inviare i pezzi di fissaggio solamente per mezzo di questo procedimento. Qualora dovete avere qualche altra reclamazione in merito al mobile, allora Vi preghiamo di rivolgerVi direttamente al Vostro Negozio di mobili.

**BG** Нашата директна услуга за обкоя  
Ако липсват части от комплекта, попълнете настоящата сервисна карта и ни я изпратете на e-mail адреса, посочен по-долу. По този начин можем да доставяме само липсващи елементи от обкоя. Ако установите други дефекти по мебелите, Ви съветваме да се обърнете към мебелната къща/магазин, от който сте закупили стоката.

**NL** Onze directservice voor losse onderdelen  
Wanneer er een onderdeel ontbreekt, kunt u deze servicekaart direct aan onderstaand e-mailadres sturen. Wij kunnen langs deze weg echter alleen beslagdelen versturen. Mocht u een ander probleem aan uw meubel hebben, verzoeken wij u contact op te nemen met uw meubeldealer.

**PL** Nasz bezpośredni serwis części montazowych  
Jeżeli brakuje części koniecznych do montażu, prosimy o przesłanie nam niniejszej karty serwisowej na niżej podany adres e-mailowy. W ten sposób możemy przesłać Państwu tylko brakujące części. W przypadku innych reklamacji dotyczących mebla, prosimy zgłosić się do salonu meblowego, w którym został dokonany zakup.

**HR** Servis za okove  
U slučaju da nedostaje neki od dijelova molimo vas da na dolje navedenu mail adresu pošaljete ovaj servisni obrazac. Na ovaj način mogu se dostaviti samo okovi. U slučaju da imate dodatne prigovore vezane uz komad namještaja molimo vas da se obratite izravno trgovini namještaja gdje je isti kupljen.

**HU** Direktszolgáltatunk vasalattok esetén  
Ha hiányzik egy vasalat, ezt a kártyát közvetlenül elküldheti az alább található címre. Azonban csakis vasalattokat tudunk így küldeni. Amennyiben másfajta reklamáció áll fenn bútordarabját illetően, forduljon közvetlenül a bútorszóhoz.

**SK** Náš priamy servis pre časti kovania  
Ak by Vám chýbala nejaká časť kovania, môžete poslať túto servisnú kartu pošlat' e-mailom na nižšie uvedenú adresu. Diely kovania vieme poslať iba týmto spôsobom. Ak by ste mali inú reklamáciu ohľadom Vášho nábytku, obráťte sa priamo na Vašu predajňu nábytku.

**SLO** Naše direktno uslužne storitve za okovje  
Če vam manjka kakšno okovje, lahko to servisno kartico pošljete po e-pošti direktno na spodnji naslov. Po tej poti vam lahko pošljemo samo okovje. Če želite reklamirati kakšen drug del pohištva, se obrnite neposredno na vašo trgovino pohištva.

**RO** Service-ul nostru direct pentru feronerie  
In cazul în care vă lipsește o piesă de feronerie puteți să trimiteți direct acest card de service prin e-mail la adresa de mai jos. Noi nu putem expedia piese de feronerie decât pe această cale. Dacă aveți o altă reclamație referitoare la piesa de mobilier, atunci vă rugăm să vă adresați direct la magazinul dvs. de mobilă.

**RUS** Наш прямой сервис для поставок фурнитуры  
Если окажется, что Вам не хватает того или иного элемента фурнитуры, Вы можете отправить сервисную карту по факсу непосредственно на нижеприведенный адрес электронной почты. Однако, таким образом мы можем пересылать лишь фурнитуру. Если же у Вас возникнут иные претензии относительно приобретенной мебели, пожалуйста, обращайтесь непосредственно в организацию, осуществившую продажу.

**S** Vår direktservice för beslagsdelar  
Om du saknar en beslagsdel kan du skicka detta servicekort direkt till e-postadressen som anges nedan. Tänk på att detta är den enda möjligheten att skicka beslagsdelar till dig. Om du vill reklamera din möbel av en annan anledning måste du kontakta ditt möbelhus direkt.

**ES** Nuestro servicio directo para accesorios  
Si le falta algún accesorio, puede enviar esta tarjeta de servicio directamente a la siguiente dirección. No obstante, por este método solo podemos enviar accesorios. Si tiene alguna otra objeción sobre su mueble, consulte directamente con su mueblería.

**TR** Donatılar için doğrudan servisimiz  
Bir donatınız eksikse bu servis kartını doğrudan aşağıda bulunan adrese doğrudan mail yazabilirsiniz. Sadece bu yolla donatılar gönderilebilir. Mobilyanızda başka şikayetleriniz varsa lütfen doğrudan mobilya satıcınıza danışın.

max.

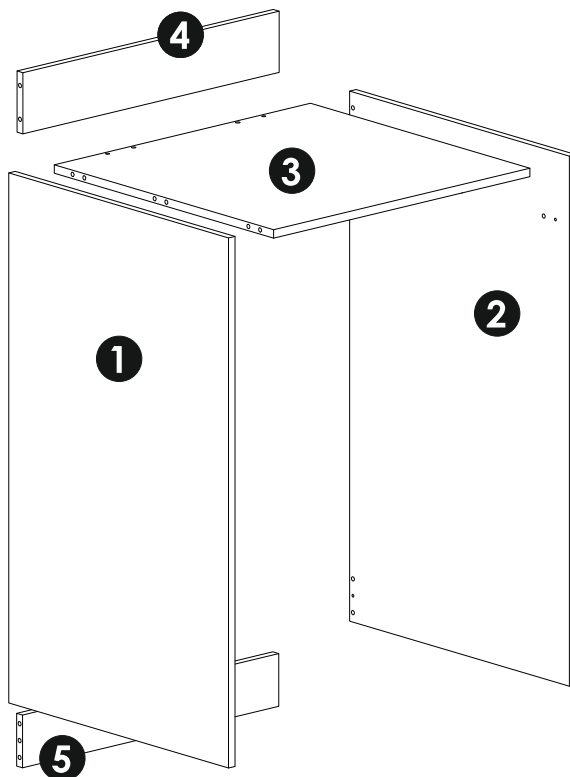

| Nr | Maße mm |     |    | Colli | Anzahl |
|----|---------|-----|----|-------|--------|
| 1  | 1005    | 600 | 16 | 1/1   | 1      |
| 2  | 1005    | 600 | 16 | 1/1   | 1      |
| 3  | 630     | 599 | 16 | 1/1   | 1      |
| 4  | 630     | 116 | 16 | 1/1   | 1      |
| 5  | 630     | 100 | 16 | 1/1   | 1      |
| B* |         |     |    | 1/1   | 1      |

Grund der Beanstandung / Reason of the objection:

Möbelhaus / Furniture store:

Name / Nom:  Telefon / Telephone:

PLZ / Bank sorting code:  Ort / City:

Strasse / Street:

Haus-Nr. / House No.:  @E-Mail:

LKZ 85020

Modellnummer / Number / Numéro du modele  
Numero / Номер на модели / modello  
Číslo modelu / Modell száma / Eíslo modelu  
Številka modela / Număr model / Broj modela  
Modelnummer / Numer modelu

**X5W ## 731**

Type / Типо / Típus / Typ / Тип / Тип

**731**

**B1**

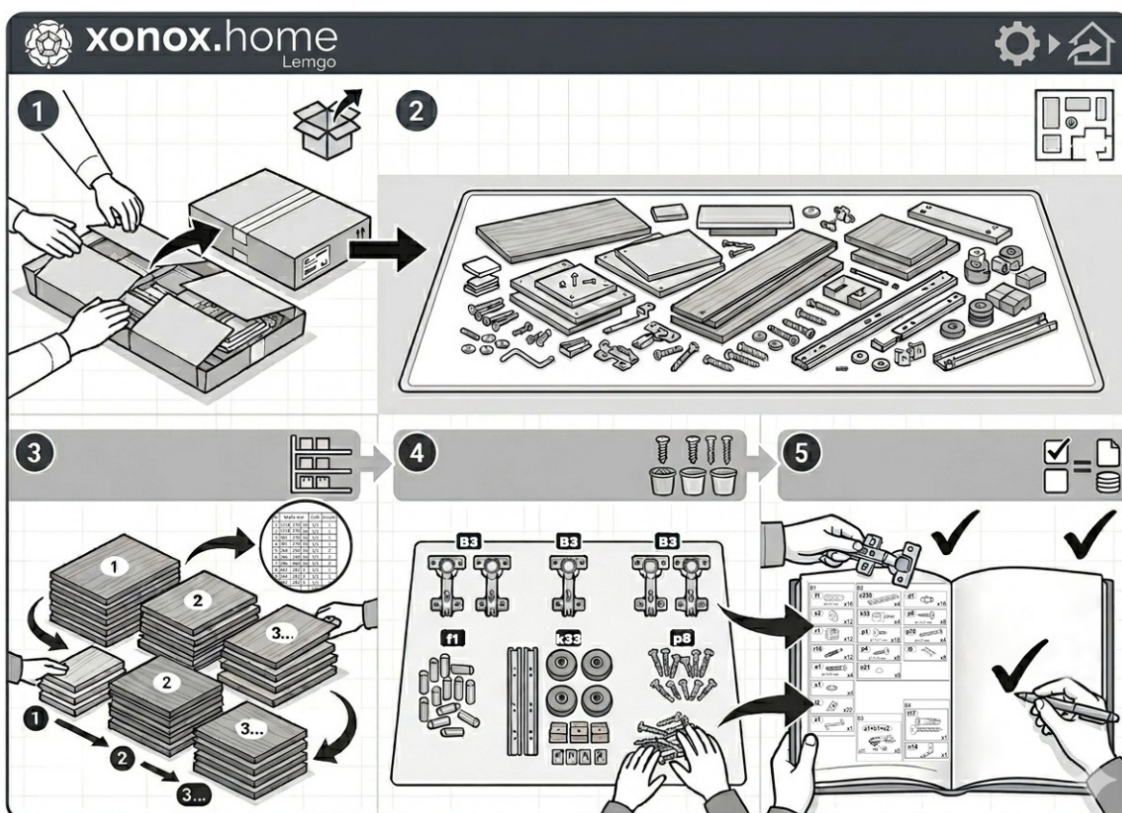
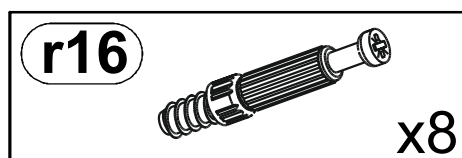
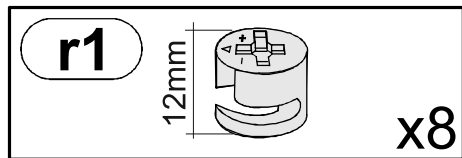
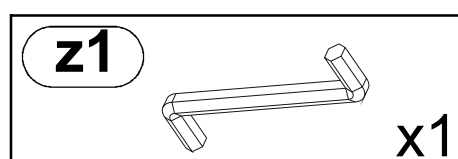
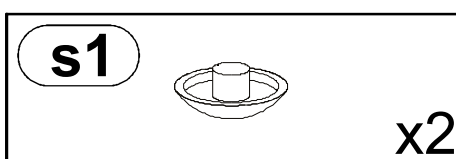
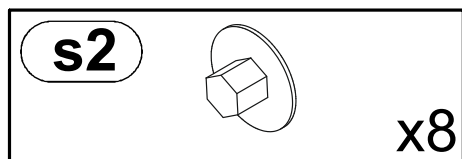
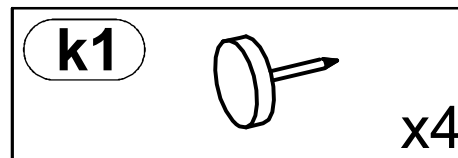
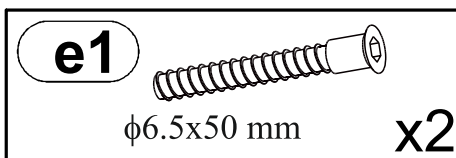
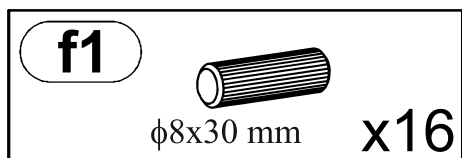

1

f1



φ8x30 mm

x16

r16



x8

k1

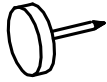

x4

r1



x8

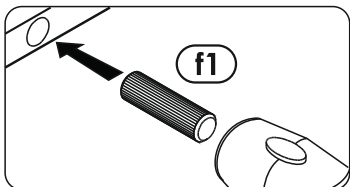
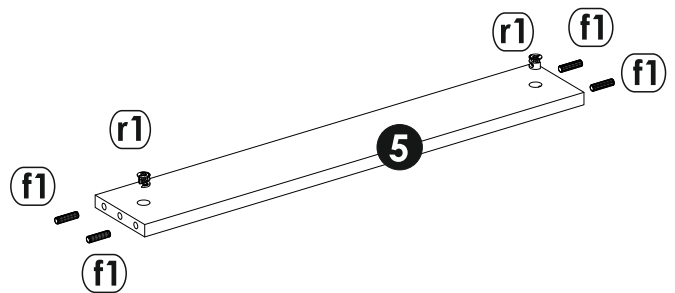
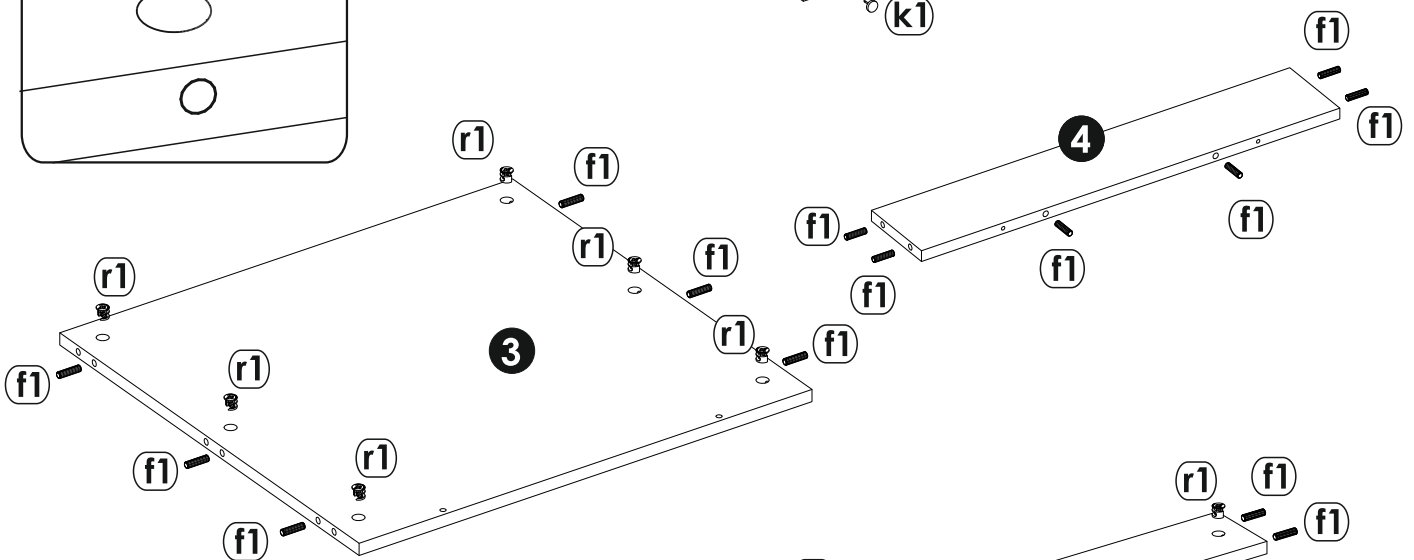
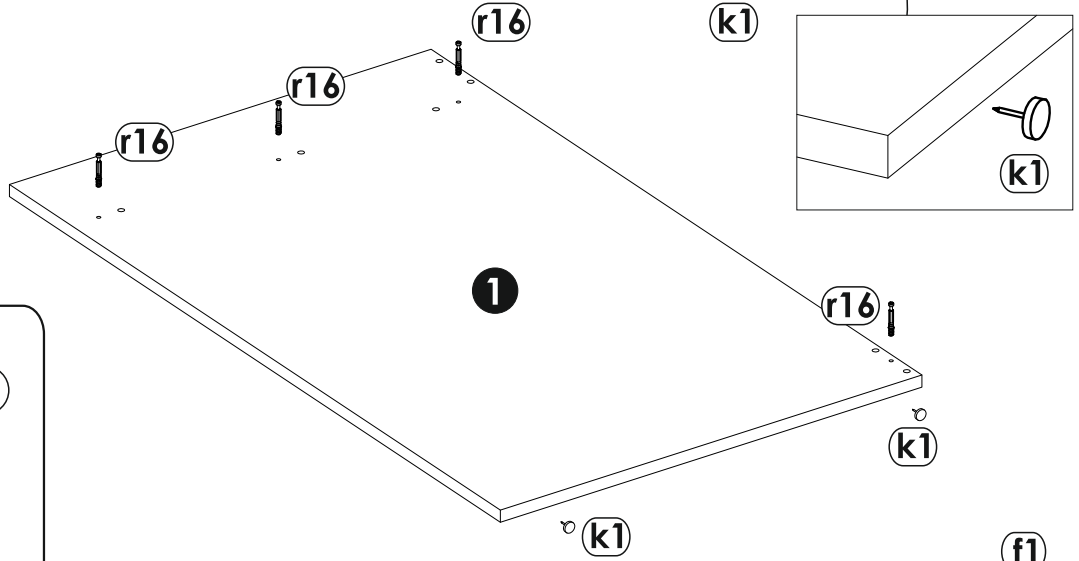
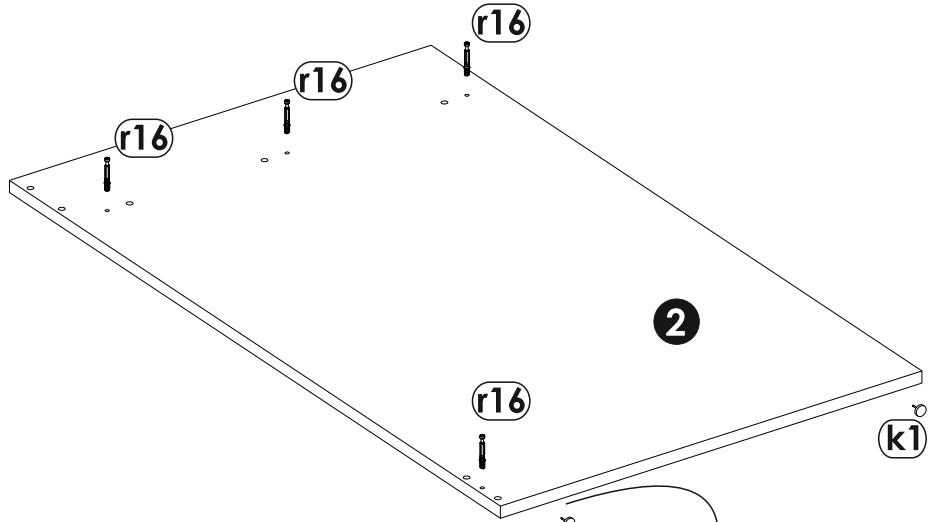
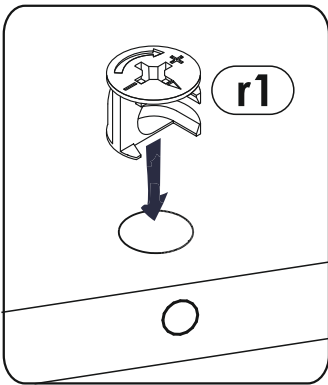
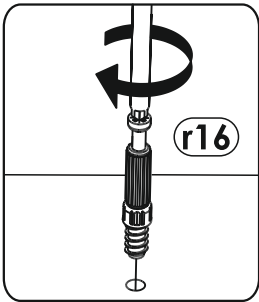
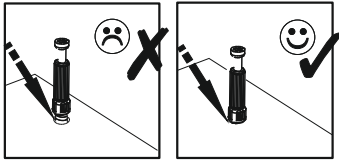
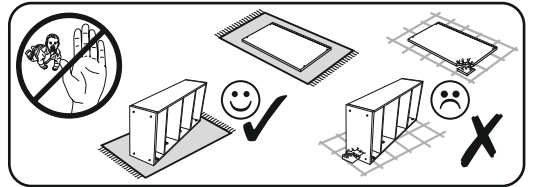

2

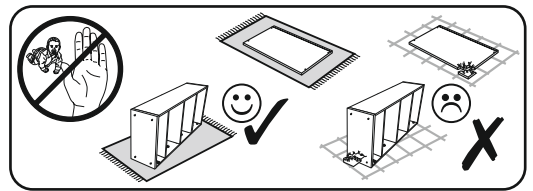
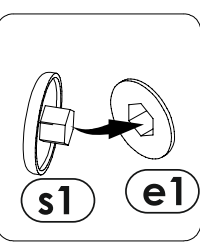
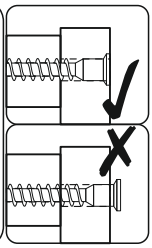
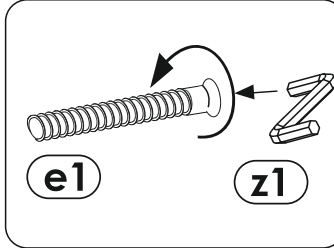
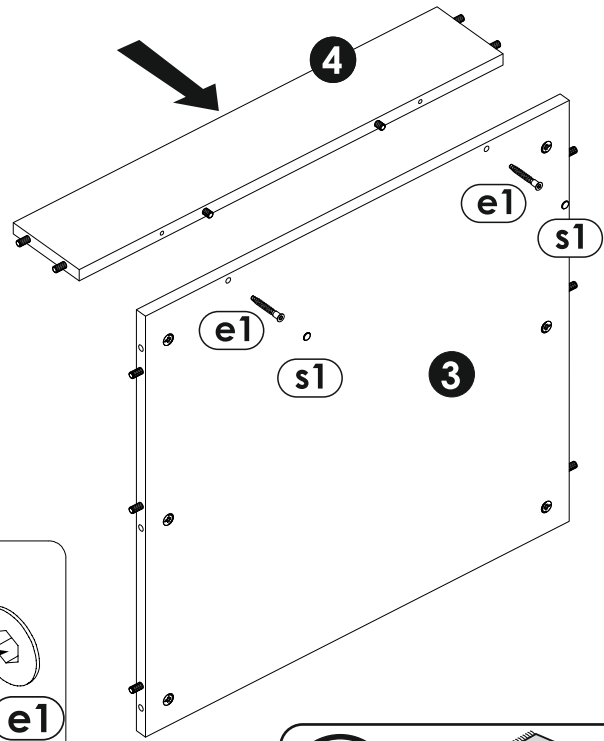
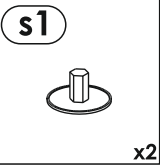
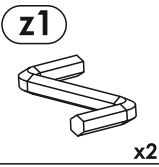

3

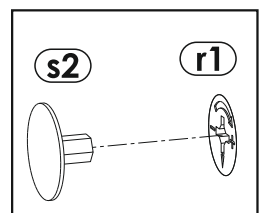
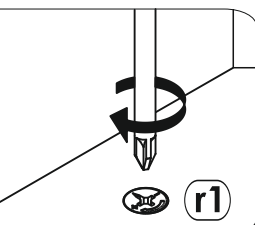
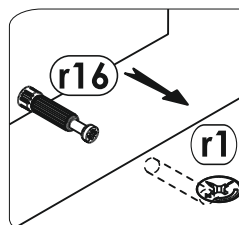
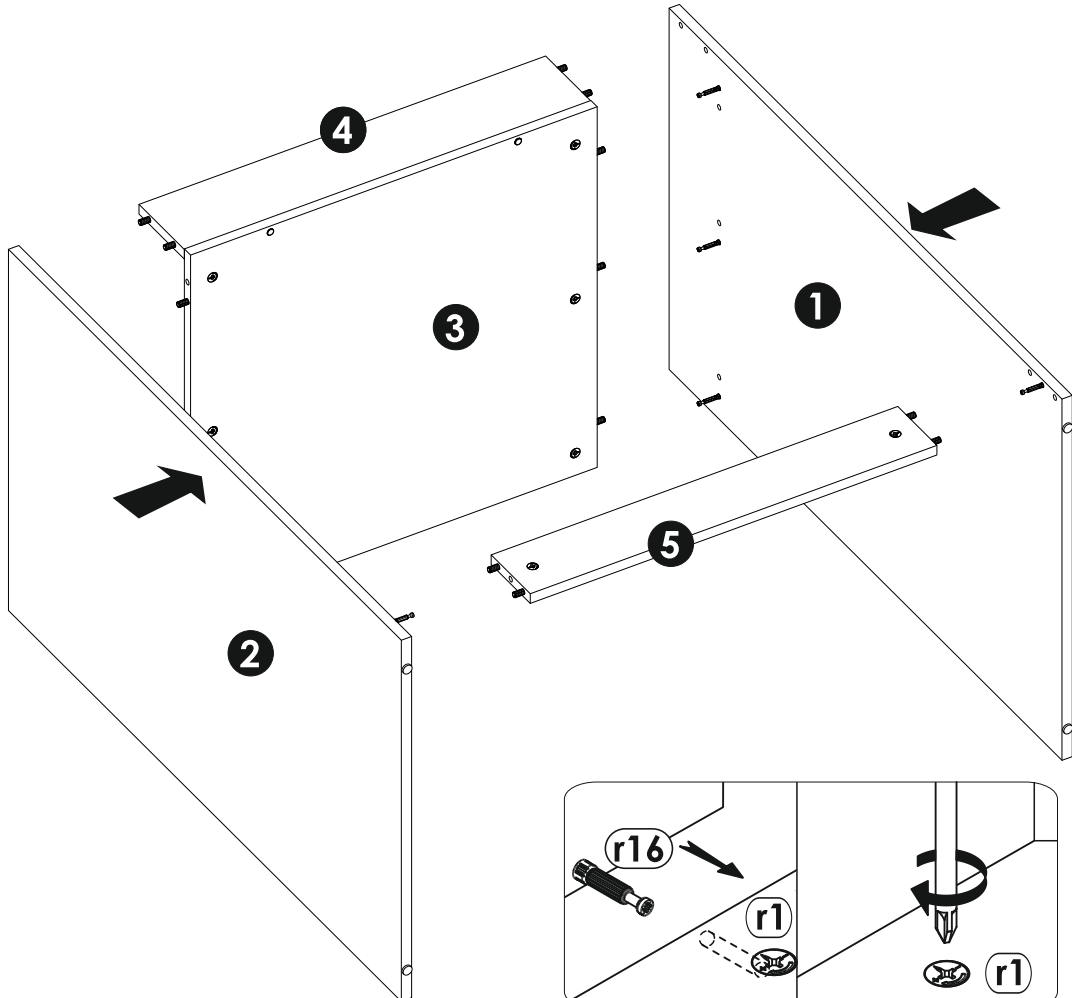
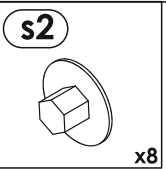

4

