

DE Montage der Rückenlehne

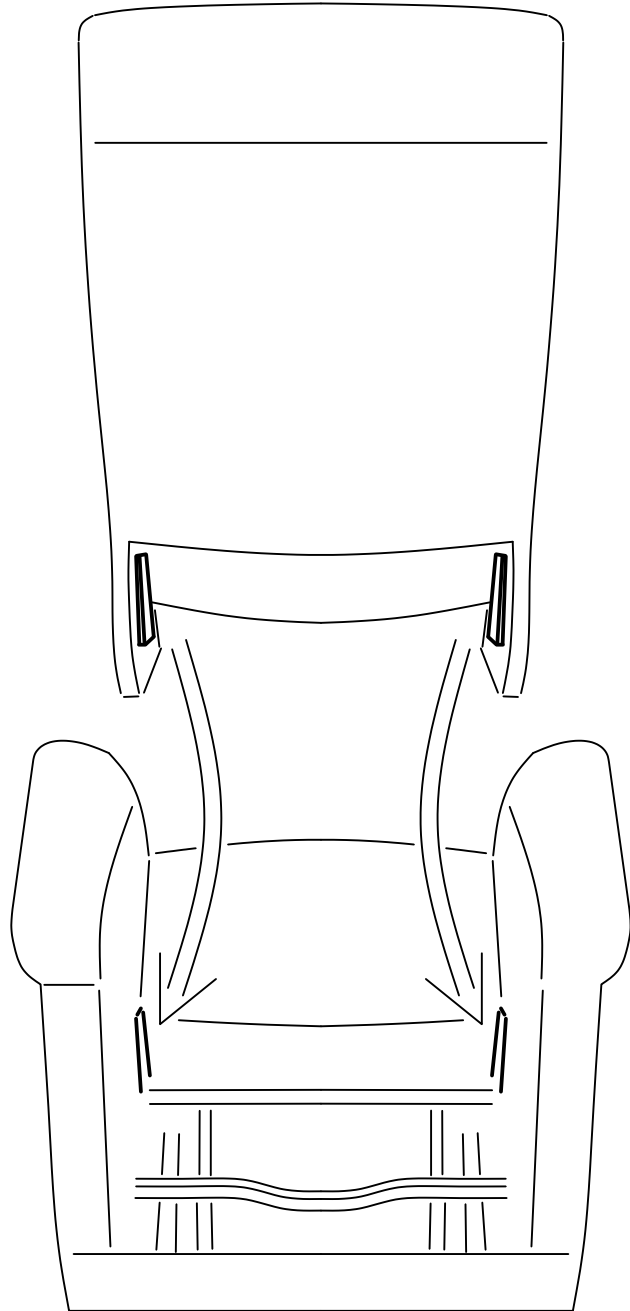

Rückansicht des Sessels

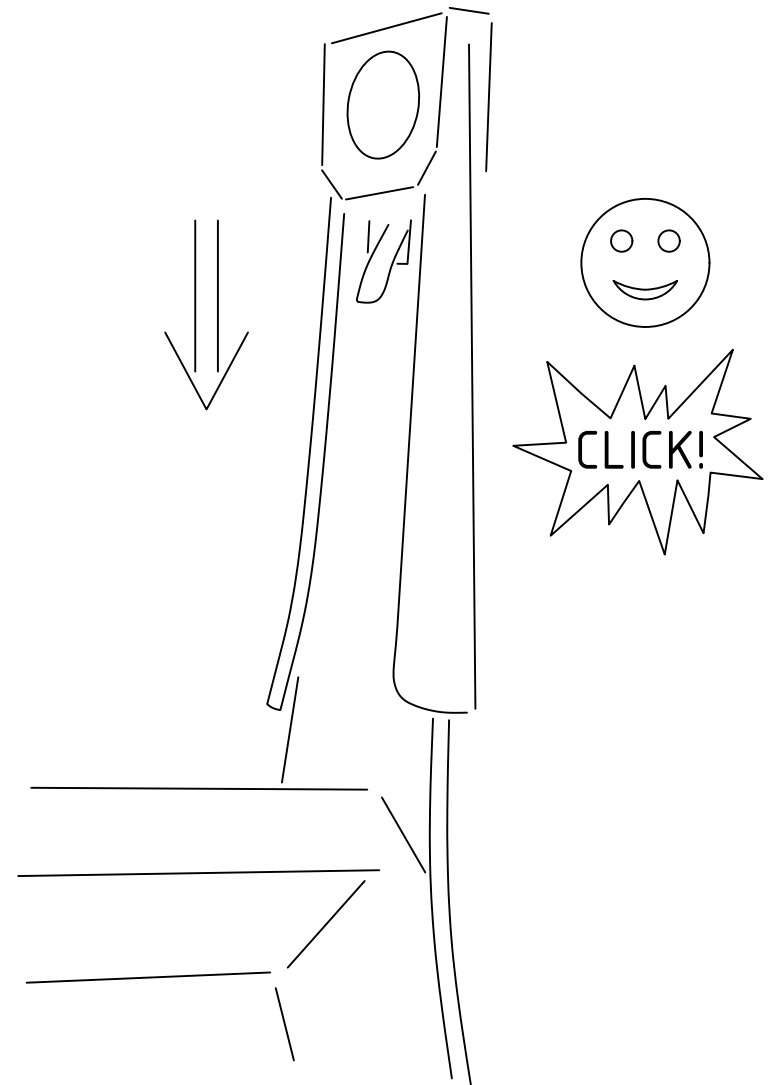

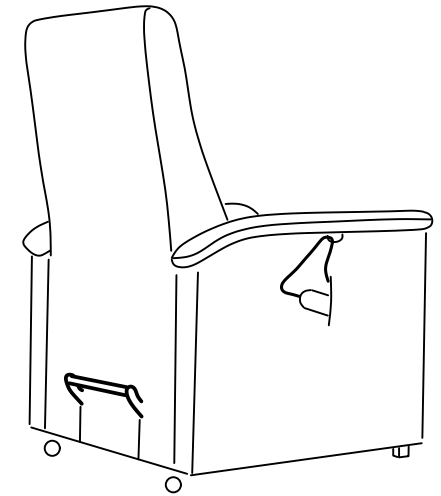
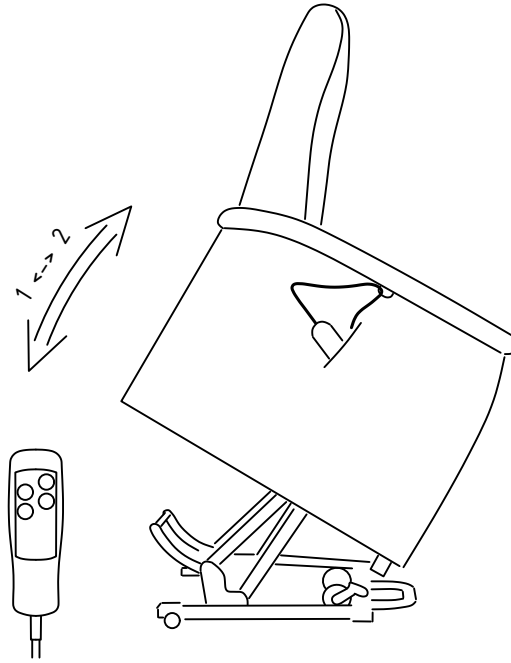
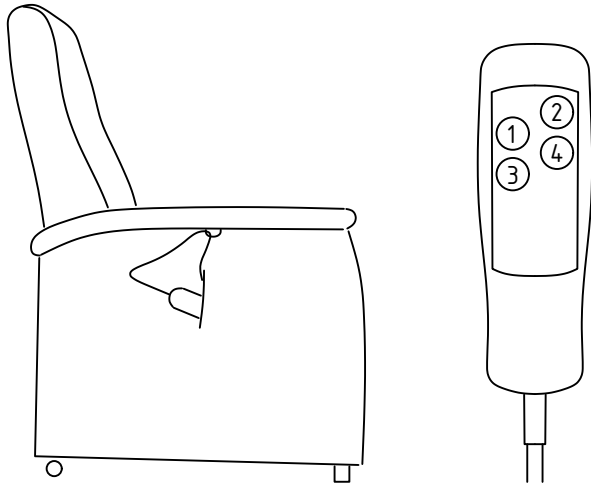

Wenn die Trolley-Funktion ausgeschaltet ist (der Hebel ist oben), kann die elektrische Funktion betätigt werden.

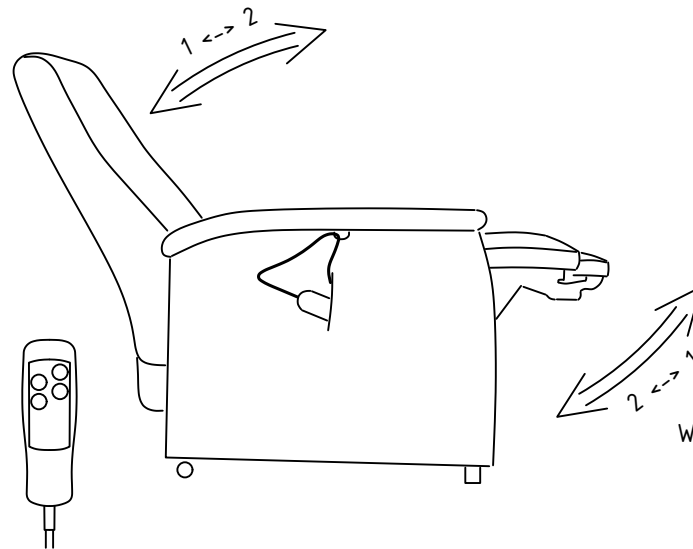
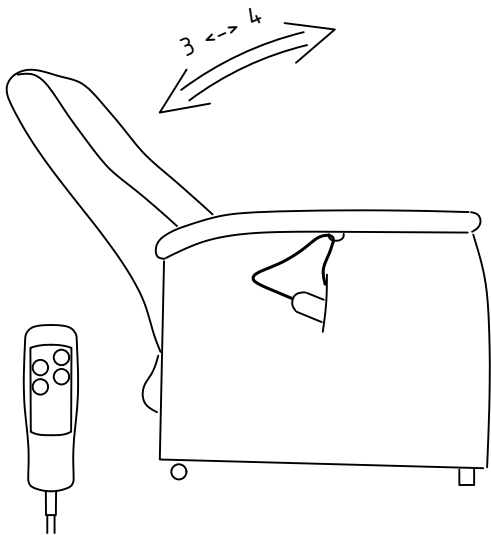

Wenn die Trolley-Funktion eingeschaltet ist (der Hebel ist unten), funktioniert die elektrische Verstellung nicht. Jetzt kann der Sessel verschoben werden

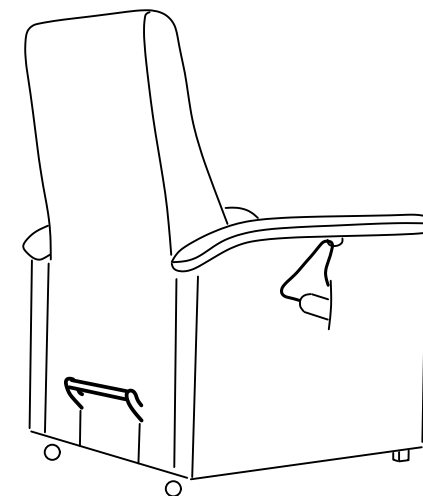
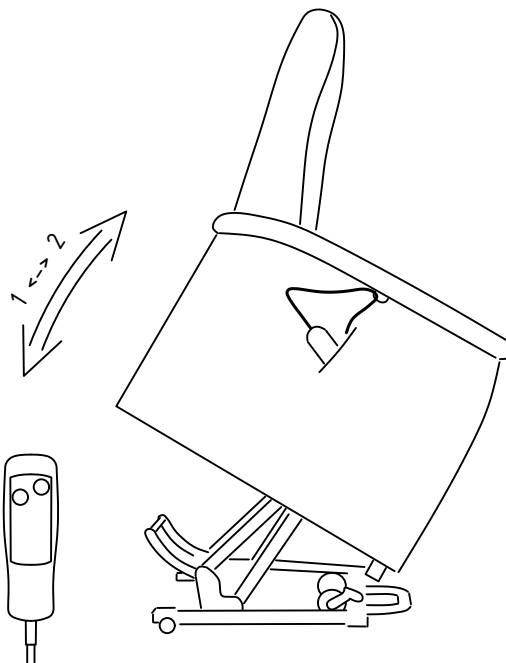
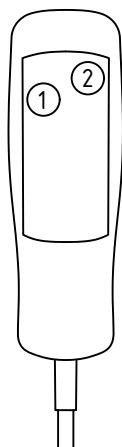
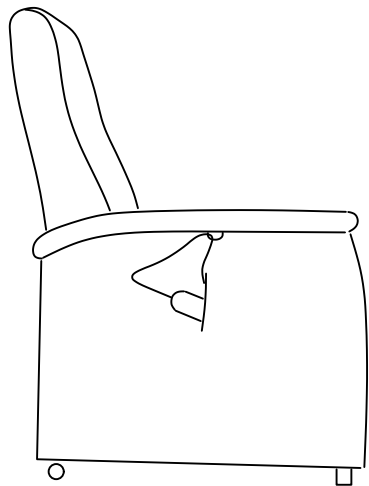

Wenn die Trolley-Funktion ausgeschaltet ist (der Hebel ist oben), kann die elektrische Funktion betätigt werden.

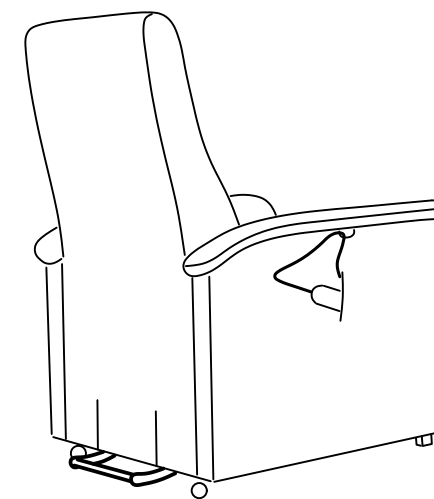
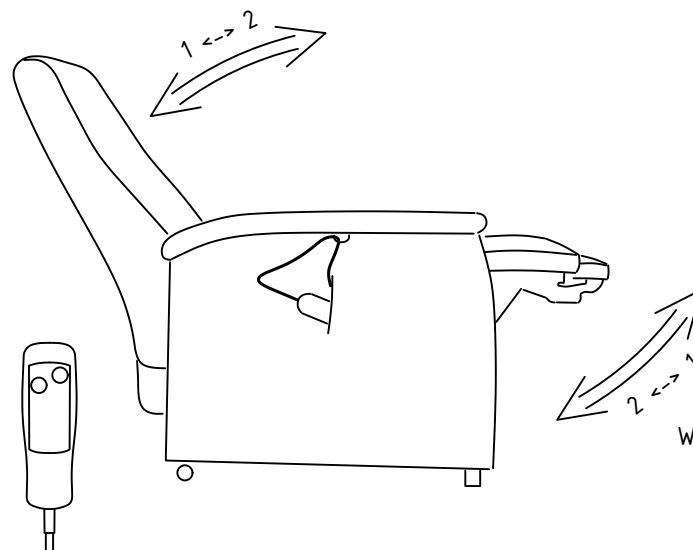

Wenn die Trolley-Funktion eingeschaltet ist (der Hebel ist unten), funktioniert die elektrische Verstellung nicht. Jetzt kann der Sessel verschoben werden

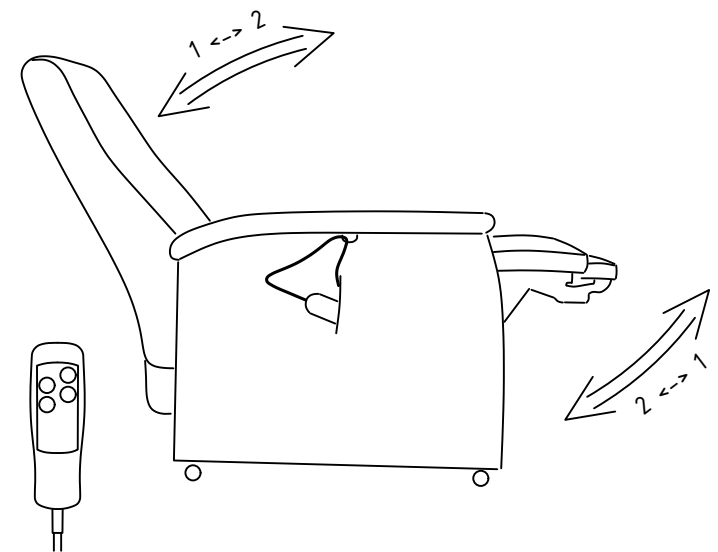
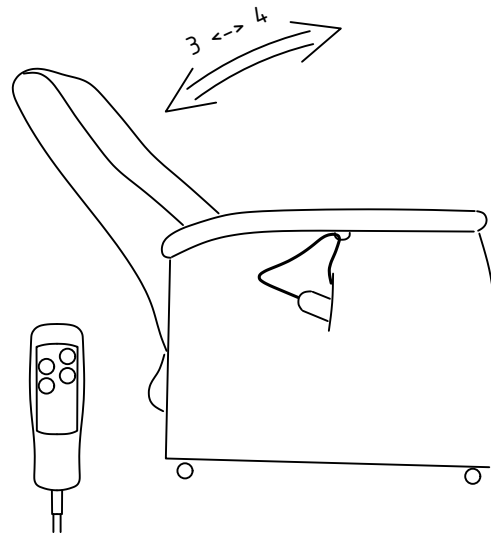
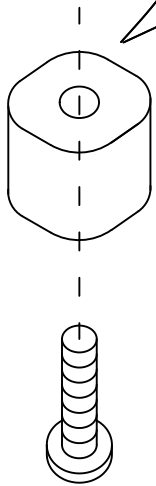
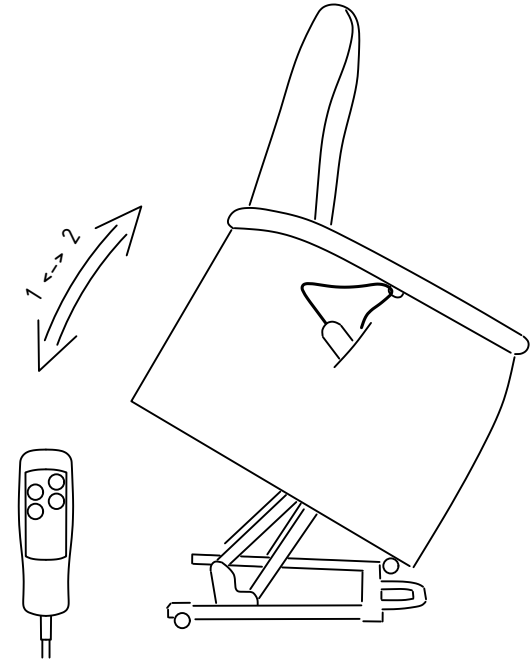
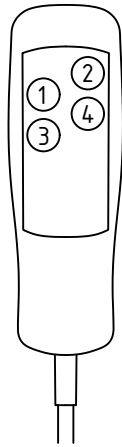
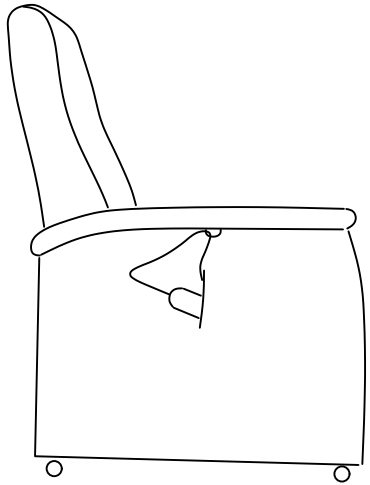

Vorderrollen können durch FüÙe ersetzt werden.

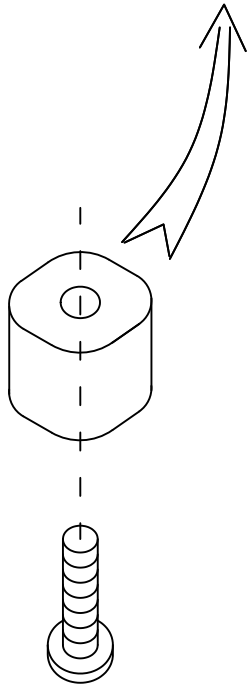
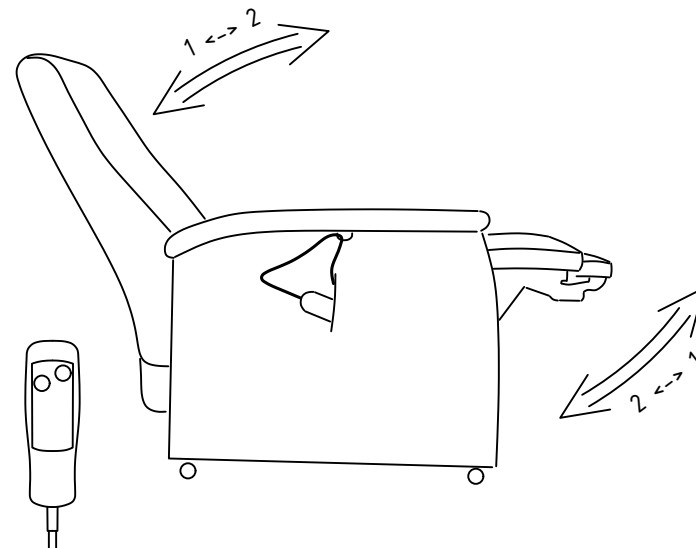
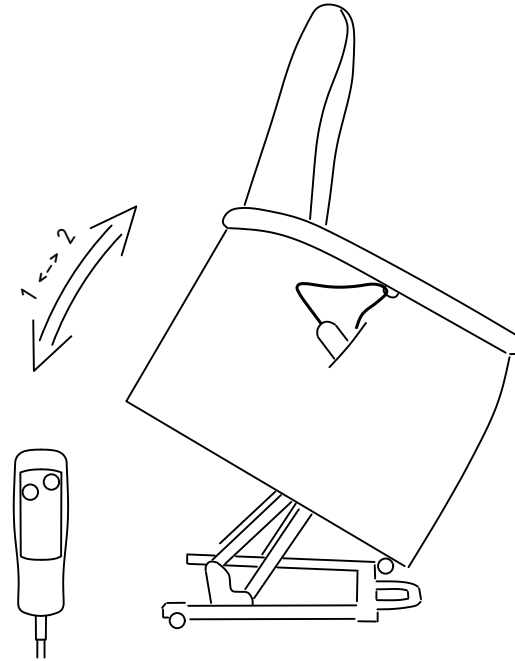
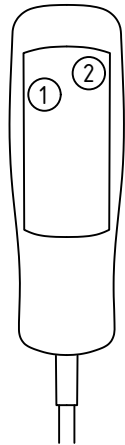
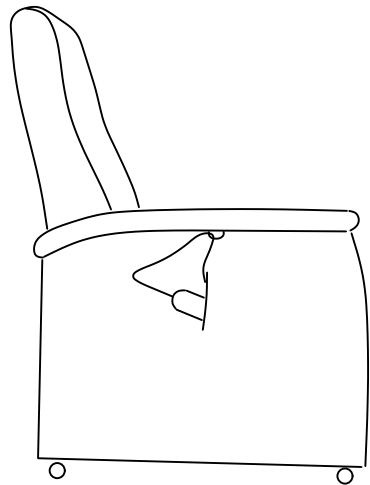

Vorderrollen können durch FüÙe ersetzt werden.

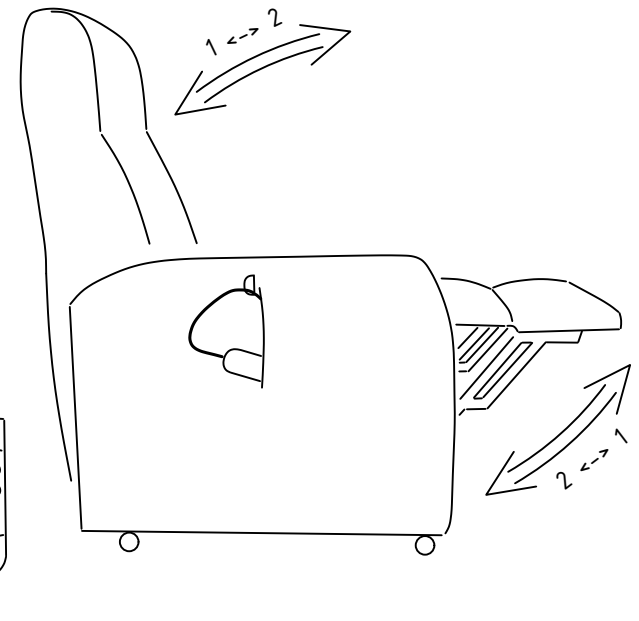
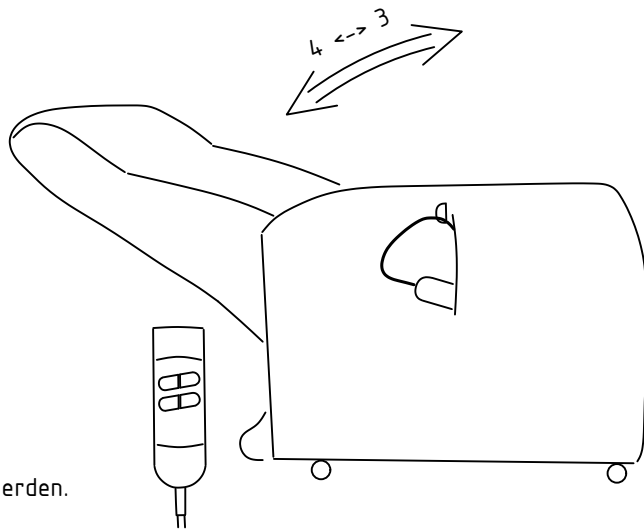
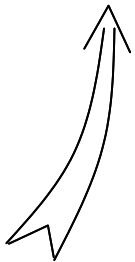
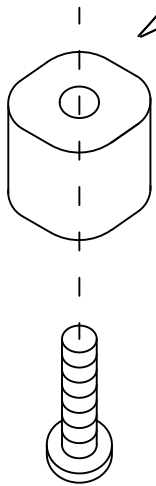
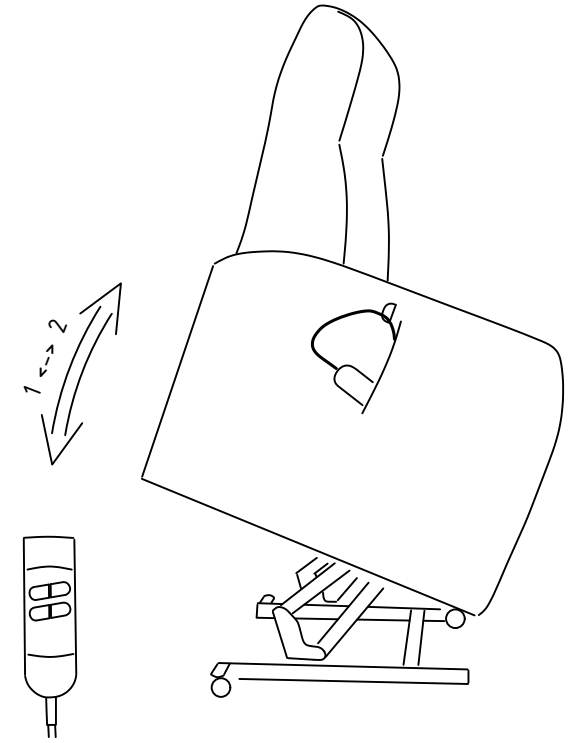
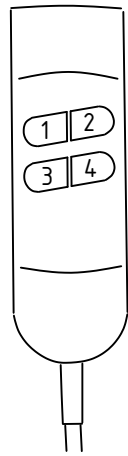
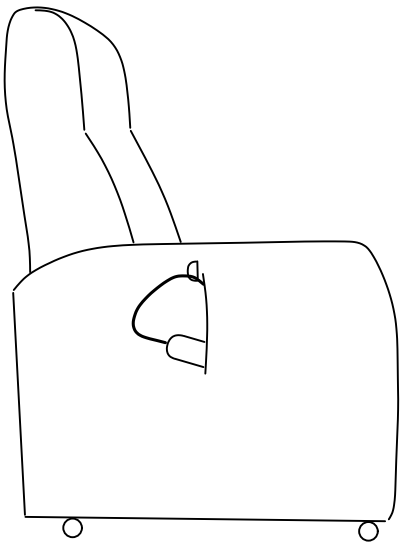

Vorderrollen können durch FüÙe ersetzt werden.

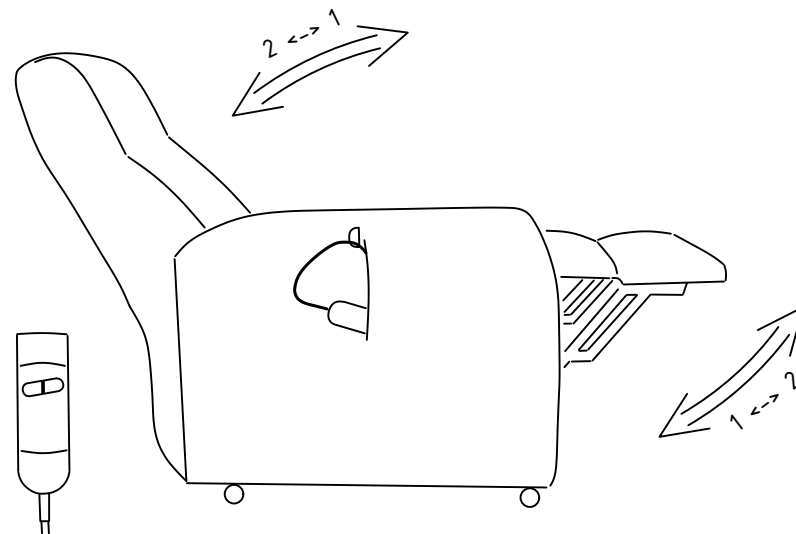
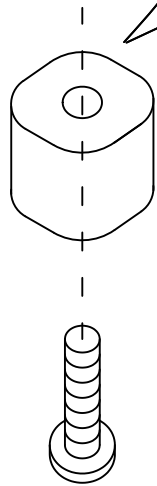
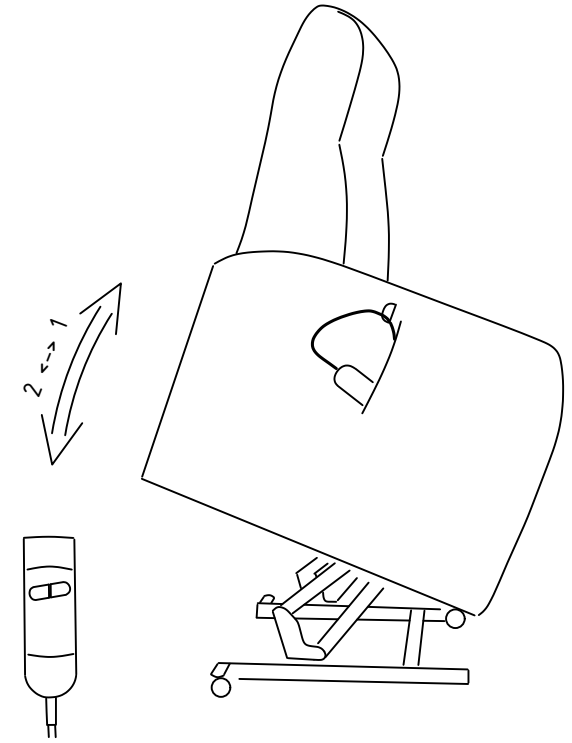
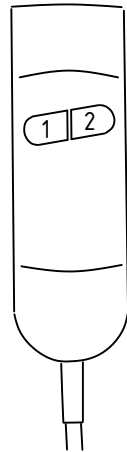
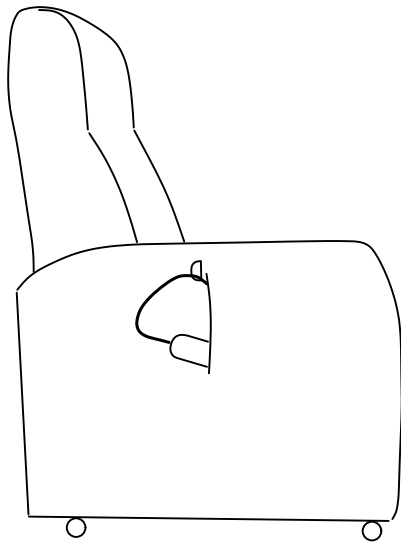

Vorderrollen können durch FüÙe ersetzt werden.

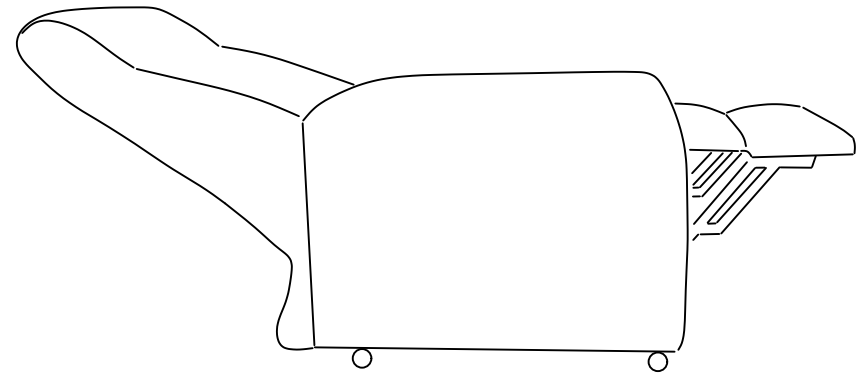
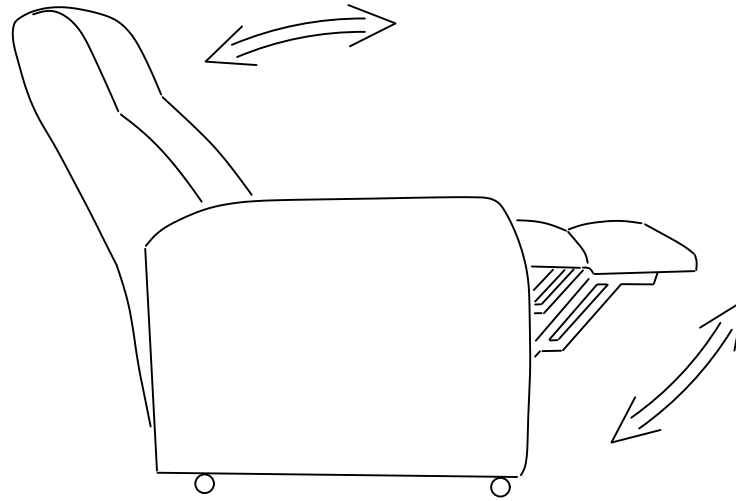
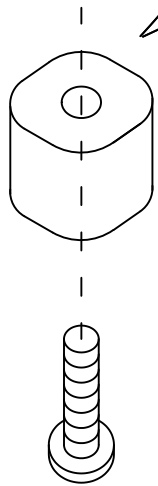
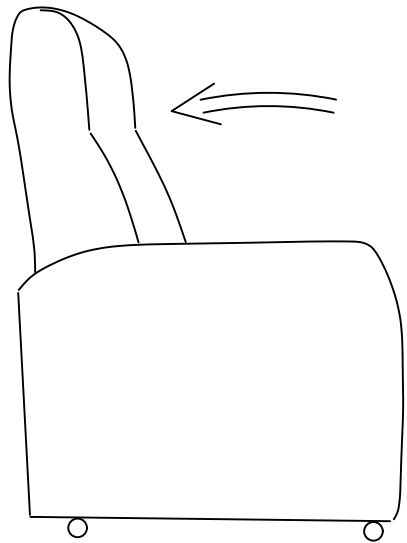

Vorderrollen können durch FüÙe ersetzt werden.