

Dieter Knoll Collection

92300005/01 92300005/04
92300005/02 92300005/05
92300005/03

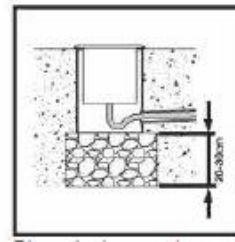

DE

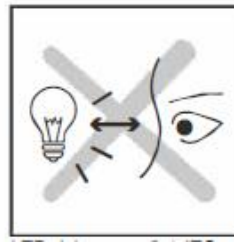

<p>Anschluss und Wartung der Leuchte dürfen nur von geschultem und qualifiziertem Fachpersonal unter Einhaltung der geltenden Vorschriften durchgeführt werden.</p>	<p>Vergewissern Sie sich, dass die Leuchte vor der Durchführung von Wartungsarbeiten von der Stromzufuhr getrennt ist.</p>	<p>LED-Risikogruppe 0–1, Norm: IEC 62471 Schauen Sie nicht direkt in die Lichtquelle, wenn diese in Betrieb ist. Dies kann zu Augenschäden führen.</p>	<p>Stellen Sie die Bodeneinbauleuchte auf eine 20–30 cm dicke Drainageschicht (Kies) und füllen Sie sie mit Wasser. Wenn das Wasser nach 30 Minuten nicht vollständig abgelaufen ist, müssen Sie ein zusätzliches Drainagesystem (z. B. ein Abflussrohr) einbauen.</p>	<p>Damit sich kein Wasser staut, darf die Bodeneinbauleuchte nicht in einer Senke installiert werden.</p>
---	--	--	--	---

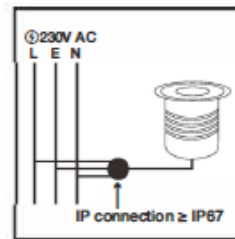
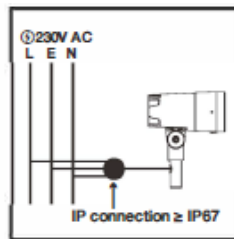
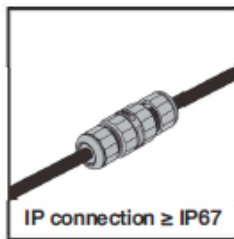
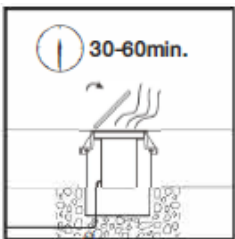

<p>Wenn Sie Bodeneinbauleuchten, Projektoren oder Poller demontieren, schalten Sie die Leuchten vor der Demontage für 30–60 Minuten ein, damit möglicherweise vorhandene Feuchtigkeit verdampft.</p>	<p>Der elektrische Anschluss von Leuchten mit werkseitig verdrahtetem Anschlusskabel muss mindestens der Schutzart IP67 entsprechen.</p>	<p>Der elektrische Anschluss von Projektoren muss mindestens der Schutzart IP67 entsprechen.</p>	<p>Der elektrische Anschluss von Bodeneinbauleuchten muss mindestens der Schutzart IP67 entsprechen.</p>	<p>Alle Leuchten sind mit einem Abdichtungssystem ausgestattet, das einen wirksamen Schutz vor dem Eindringen von Wasser und Feuchtigkeit entlang der Anschlusskabel bietet.</p>
--	--	--	--	--

Dieter Knoll Collection

92300005/01 92300005/04
92300005/02 92300005/05
92300005/03

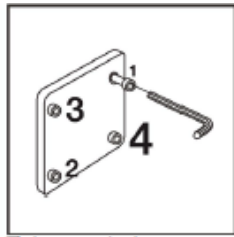

<p>Wenn das äußere, flexible Kabel der Leuchte beschädigt ist, darf es ausschließlich vom Hersteller oder einer qualifizierten Fachkraft ersetzt werden, um Gefahren zu vermeiden.</p>	<p>Ziehen Sie Schrauben abwechselnd oder über Kreuz an. Gehen Sie genauso vor, wenn Sie Schrauben lösen.</p>	<p>Für eine einfache Wartung (Abschrauben) der Leuchte wird empfohlen, die Schraubengewinde mit Silikonfett zu schützen, bevor die Leuchte der Witterung ausgesetzt wird.</p>	<p>Halten Sie die Leuchte sauber, um zu vermeiden, dass sich am Rahmen und an den Schrauben Schmutz ablagert. Verwenden Sie für Bestandteile aus Edelstahl nur speziell dafür vorgesehene Reinigungsmittel.</p>	<p>Setzen Sie die Leuchte keinen aggressiven Mitteln oder chemischen Stoffen (z. B. Dünger, Unkrautvernichtungsmittel, Kalk) aus.</p>
--	--	---	---	---

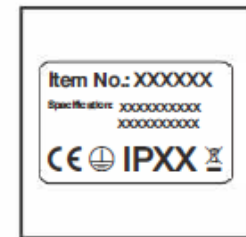
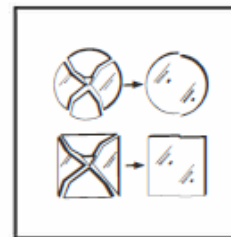

<p>Verwenden Sie keinen Hochdruckreiniger.</p>	<p>Es handelt sich um ein elektronisches Gerät, das empfindlich auf Überspannung reagiert. Die Installation eines Überspannungsschutzes dämpft die Intensität von Überspannungsstößen und schützt Geräte vor Schäden.</p>	<p>Falls der Diffusor beschädigt ist, wechseln Sie ihn aus, bevor Sie die Leuchte einschalten.</p>	<p>Bewahren Sie diese Anweisungen auf.</p>	<p>Die technischen Daten sind auf dem Typenschild des Produkts angegeben.</p>
--	---	--	--	---

Demontage des LED-Moduls

Trennen Sie die Leuchte vom Stromnetz, bevor Sie sie auseinandernehmen.

- 1: schrauben Sie die Glasabdeckung gegen den Uhrzeigersinn ab.
- 2: nehmen Sie das Aluminiumrohr nach oben hin ab.
- 3: entfernen Sie die Schrauben der Abdeckplatte
- 4: entfernen Sie die Batterien

Dieses Produkt enthält mehrere Lichtquellen der Energieeffizienzklasse: G

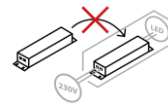

Betriebsgerät nicht austauschbar.

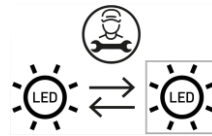

Austausch der LED-Lichtquelle durch eine Fachkraft.

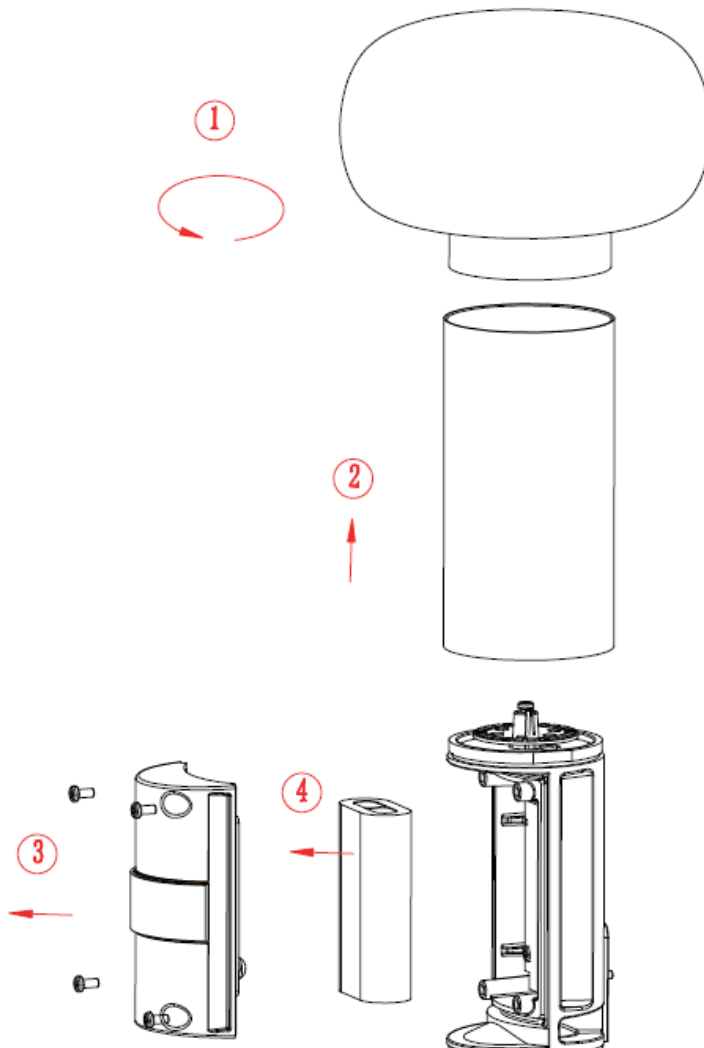

Dieter Knoll Collection

92300005/01
92300005/02
92300005/03

92300005/04
92300005/05



TOUCH-SCHALTER (EIN/AUS)
Memory-Funktion für Helligkeit. Jedes Mal, wenn Sie die Leuchte einschalten, leuchtet sie mit der zuletzt eingestellten Helligkeit.

STUFENLOSES DIMMEN
Diese Funktion ist nur verfügbar, wenn die Leuchte eingeschaltet ist.

FARBTEMPERATURSCHALTER
Diese Funktion ist nur verfügbar, wenn die Leuchte ausgeschaltet ist.

Dieter Knoll Collection

92300005/01 92300005/04
92300005/02 92300005/05
92300005/03



Die Leuchte schaltet automatisch den Farbtemperatur-Umschaltmodus aus, wenn innerhalb von 10 Sekunden keine Bedienung erfolgt.

GERÄT LADEN

ORANGE → GREEN

TABLE LAMP IP65

CONNECTING CHARGING BASE IP20

HOT

Avoid direct sunlight

Dieter Knoll Collection

92300005/01 92300005/04
92300005/02 92300005/05
92300005/03



CZ:

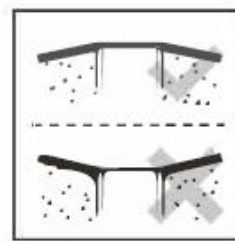
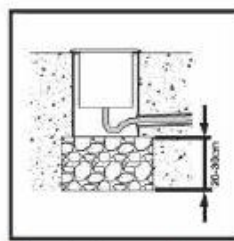
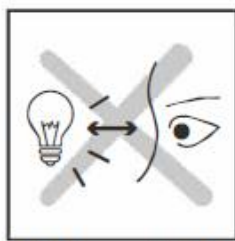
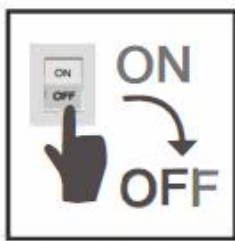

<p>Připojení a údržbu svítidla smí provádět pouze vyškolený a kvalifikovaný odborný personál v souladu s platnými předpisy.</p>	<p>Před prováděním údržby se ujistěte, že je svítidlo odpojeno od napájení.</p>	<p>Riziková skupina LED 0-1, norma: IEC 62471 Nedívejte se přímo do zdroje světla, když je v provozu. To může vést k poškození zraku.</p>	<p>Umístěte světlo do země na 20-30 cm silnou drenážní vrstvu (štěrk) a naplňte ji vodou. Pokud voda po 30 minutách zcela neodteče, je nutné nainstalovat dodatečný systém (např. odtokové potrubí).</p>	<p>Aby se zabránilo hromadění vody, nesmí být podlahové svítidlo instalováno v prohlubni.</p>
---	---	---	--	---

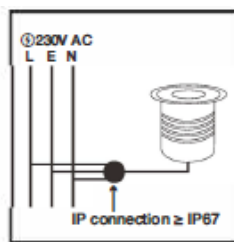
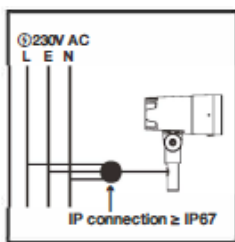
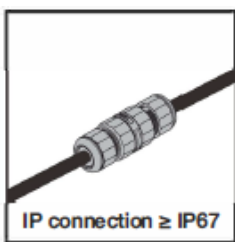
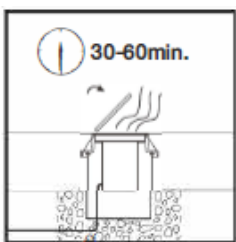

<p>Pokud demontujete podlahová svítidla, projektory nebo sloupky, zapněte je před demontáží na 30-60 minut, aby se odpařila případná vlhkost.</p>	<p>Elektrická přípojka svítidel s přípojovacím kabelem z výroby musí splňovat minimálně stupeň ochrany IP67.</p>	<p>Elektrická přípojka projektorů musí splňovat minimálně stupeň ochrany IP67.</p>	<p>Elektrická přípojka zapuštěných podlahových svítidel musí splňovat minimálně stupeň ochrany IP67.</p>	<p>Všechna svítidla jsou vybavena těsnícím systémem, který zajišťuje účinnou ochranu proti vniknutí vody a vlhkosti podél přípojovacích kabelů.</p>
---	--	--	--	---

Dieter Knoll Collection

92300005/01 92300005/04
92300005/02 92300005/05
92300005/03

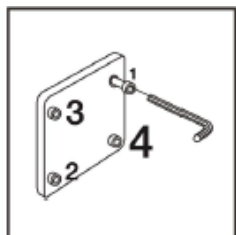

Pokud je vnější, ohebný kabel svítidla poškozený, smí ho vyměnit pouze výrobce nebo kvalifikovaná osoba za účelem zajištění bezpečnosti.

Šrouby utahujte střídaně nebo křížem. Stejně postupujte i při povolování šroubů.

Pro snadnou údržbu (vyšroubování) svítidla doporučujeme závit šroubů před vystavením svítidla povětrnostním vlivům chránit silikonovým mazivem.

Udržujte svítidlo v čistotě, aby se na rámu a šroubech nehromadily nečistoty. Pro čištění dílů z nerezové oceli používejte pouze prostředky určené na čištění nerezové oceli.

Nevystavujte svítidlo agresivním nebo chemickým látkám (např. hnojiva, přípravky na hubení plevelu, vápno).

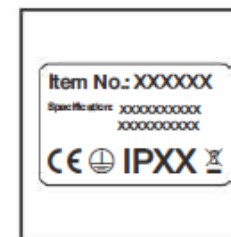
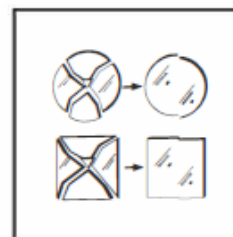

Nepoužívejte vysokotlaké čističe.

Jedná se o elektronické zařízení, které citlivě reaguje na přepětí. Instalace přepětivé ochrany tlumí intenzitu přepětí a chrání zařízení před poškozením.

Pokud je difuzor poškozený, vyměňte jej před zapnutím světla.

Návod k použití si uschovejte.

Technické údaje jsou uvedeny na výrobním štítku.

Demontáž LED modulu:

Před rozebráním svítidla jej odpojte od elektrické sítě.

1: odšroubujte skleněný kryt proti směru hodinových ručiček.

2: vyjměte hliníkovou trubku směrem nahoru.

3: Odstraňte šrouby krycí desky

4: vyjměte baterie

Tento výrobek obsahuje několik žárovek třídy energetické účinnosti: G

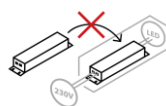

Ovládací zařízení nelze vyměnit.

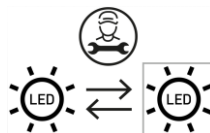

Výměna LED žárovky odborníkem.

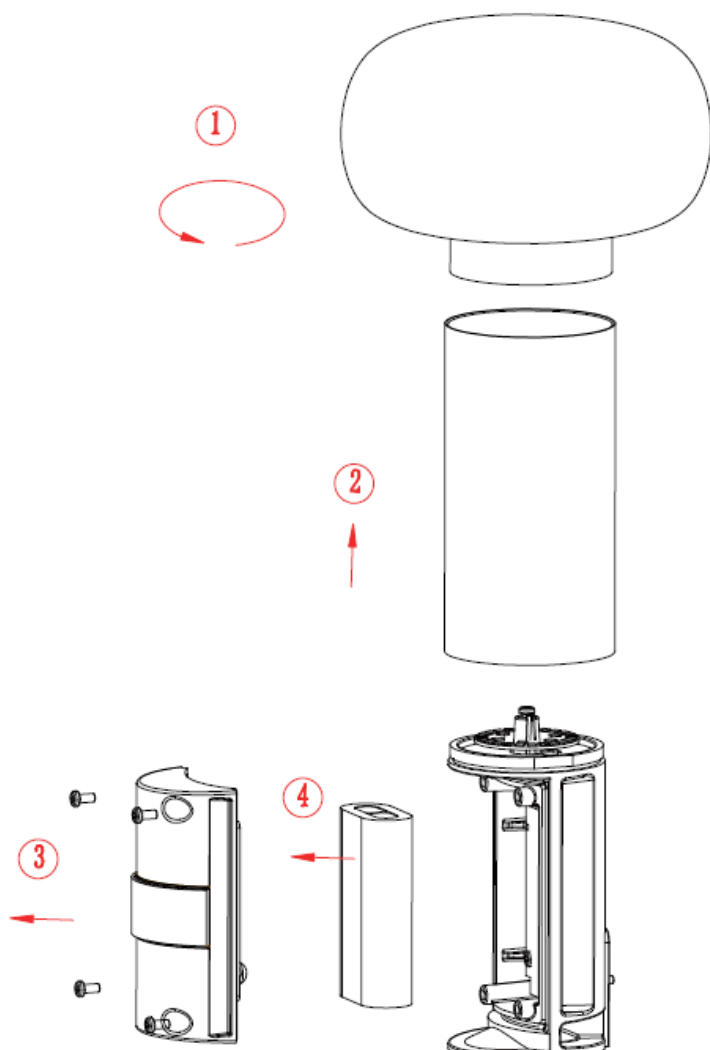

Dieter Knoll Collection

92300005/01
92300005/02
92300005/03

92300005/04
92300005/05



**DOTYKOVÝ SPÍNAČ
(ZAPNUTÍ/VYPNUTÍ)**
Paměťová funkce pro jas.
Pokaždé, když světlo zapnete,
rozsvítí se s naposledy
nastaveným jasnem.

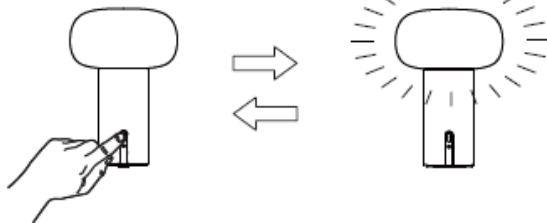
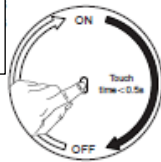

PLYNULÉ STMÍVÁNÍ
Tato funkce je dostupná pouze,
pokud je svítidlo zapnuté.

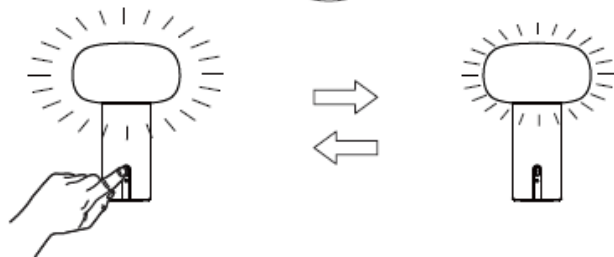
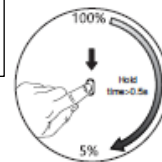

PŘEPÍNAČ TEPLoty BAREV
Tato funkce je dostupná pouze,
pokud je svítidlo vypnuté.

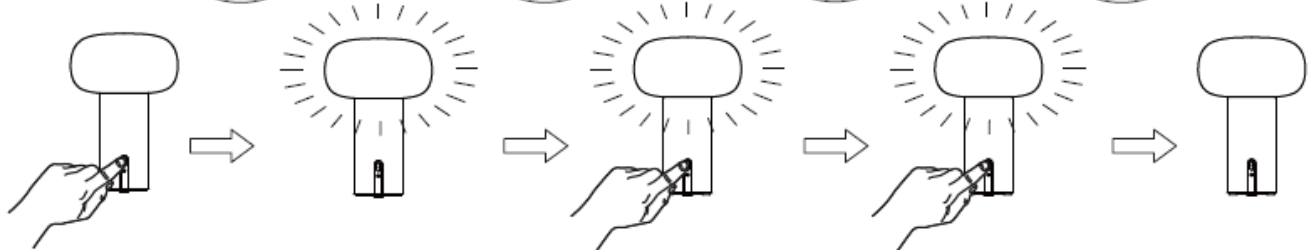
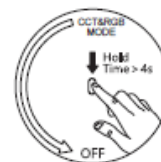
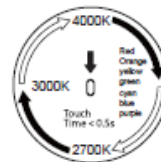
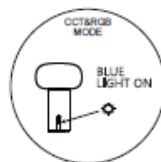
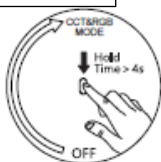

Dieter Knoll Collection

92300005/01 92300005/04
92300005/02 92300005/05
92300005/03



Svítlidlo se automaticky vypne z režimu přepínání barevné teploty, pokud během 10 sekund nezažádáte žádné ovládací pokyny.

NABÍJENÍ ZAŘÍZENÍ

ORANGE GREEN

Auto Off Time=10s

USB Adapter DC5V 1A (Optional)

TABLE LAMP IP65

CONNECTING CHARGING BASE E20

HOT

Avoid direct sunlight

Dieter Knoll Collection

92300005/01 92300005/04
92300005/02 92300005/05
92300005/03



SE:

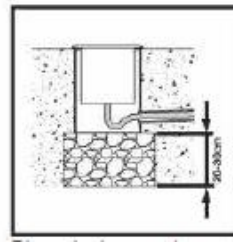
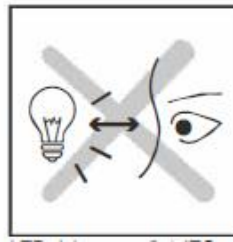
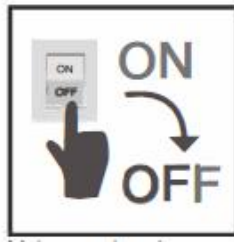

<p>Anslutning och underhåll av lampan får endast utföras av utbildad och kvalificerad fackpersonal i enlighet med gällande föreskrifter.</p>	<p>Se till att lampan är frånkopplad från strömförsörjningen innan underhållsarbeten utförs.</p>	<p>LED-riskgrupp 0–1, norm: IEC 60335-62471 Titta inte direkt in i ljuskällan när den används. Detta kan leda till ögonskador.</p>	<p>Placera den infällda golvlampan på ett 20-30 cm tjockt dräneringslager (grus) och fyll på med vatten. Om vattnet inte har runnit ut helt efter 30 minuter måste du installera ett extra dräneringssystem (t.ex. ett dräneringsrör).</p>	<p>För att förhindra att vatten samlas får den infällda golvlampan inte installeras i en sänka.</p>
--	--	--	--	---

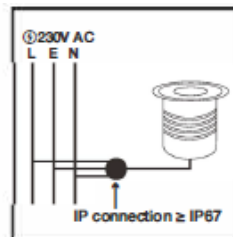
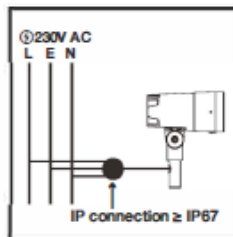
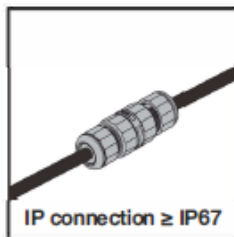
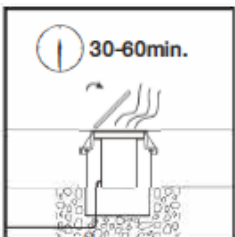

<p>Vid demontering av infällda golvlampor, strålkastare eller pollare ska lamporna tändas 30-60 minuter före demonteringen så att eventuell fukt kan avdunsta.</p>	<p>Den elektriska anslutningen av lampor med en fabriksmonterad anslutningskabel måste minst uppfylla skyddsklass IP67.</p>	<p>Den elektriska anslutningen av projektörer måste minst uppfylla skyddsklass IP67.</p>	<p>Den elektriska anslutningen av infällda golvlampor måste minst uppfylla skyddsklass IP67.</p>	<p>Alla lampor är utrustade med ett tätningssystem som ger ett effektivt skydd mot inträngande vatten och fukt längs anslutningskablarna.</p>
--	---	--	--	---

Dieter Knoll Collection

92300005/01 92300005/04
92300005/02 92300005/05
92300005/03

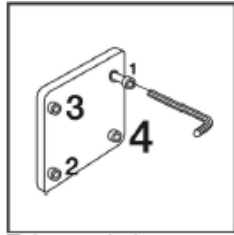

Om lampans yttre, flexibla kabel är skadad får den endast ersättas av tillverkaren eller annan kvalificerad fackpersonal för att undvika faror.

Dra åt skruvarna växelvis eller korsvis. Gör på samma sätt när du lossar skruvarna.

För att underlätta underhållet (skruva loss) av lampan rekommenderar vi att du skyddar skruvgängorna med silikonfett innan lampan utsätts för väder och vind.

Håll lampan ren så att det inte samlas smuts på ramen och skruvarna. Använd endast rengöringsmedel som är speciellt avsedda för beståndsdelar i rostfritt stål.

Utsätt inte lampan för aggressiva medel eller kemiska ämnen (t.ex. gödningsmedel, ogräsbekämpningsmedel, kalk).

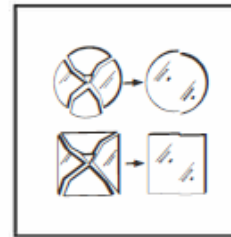
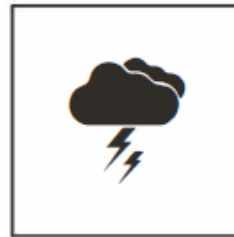

Använd inte högtryckstvätt.

Detta är en elektronisk apparat som reagerar känsligt på överspänning. Installation av överspänningskydd dämpar intensiteten i överspänningsstötar och skyddar apparater från skador.

Om diffusorn är skadad, byt ut den innan du tänder lampan.

Spara denna bruksanvisning.

Tekniska uppgifter anges på produktens märkskylt.

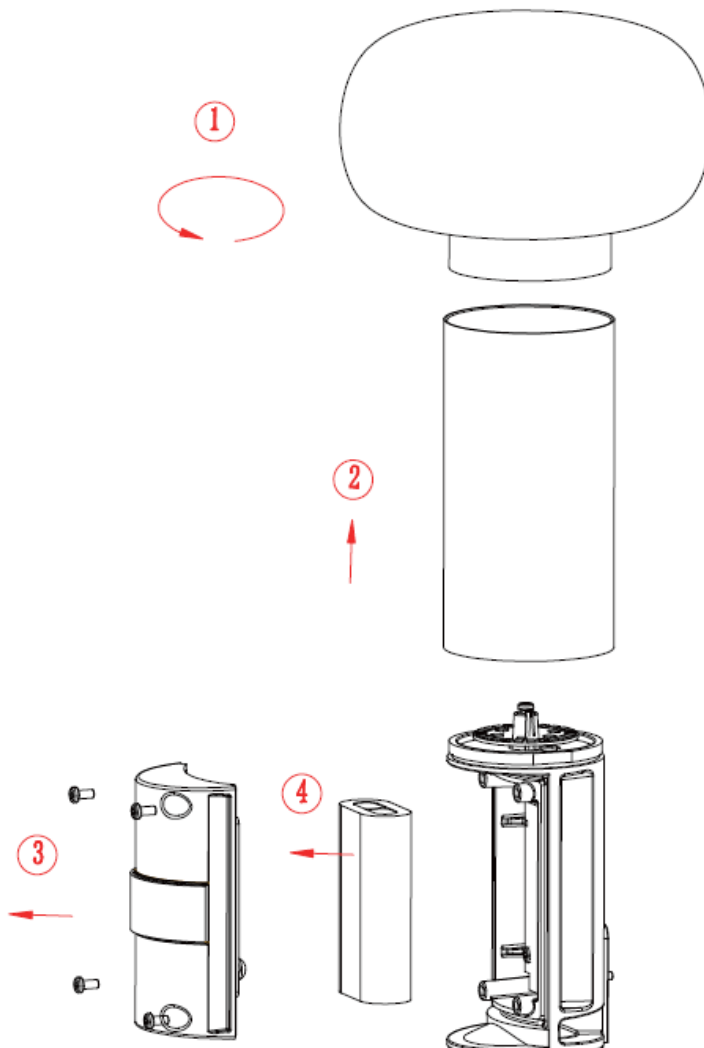

Demontering av LED-modulen

Dra ut lampans kabel ur eluttaget innan du tar isär den.

1: skruva av glasskyddet moturs.

2: ta bort aluminiumröret uppåt.

3: Ta bort täckplattans skruvar

4: ta ur batterierna

Denna produkt innehåller flera ljuskällor med energiklass: G

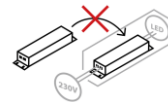

Apparaten är ej utbytbar.

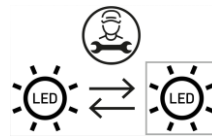

Byte av LED-ljuskällan utförs av kvalificerad fackpersonal.

Dieter Knoll Collection

92300005/01
92300005/02
92300005/03

92300005/04
92300005/05

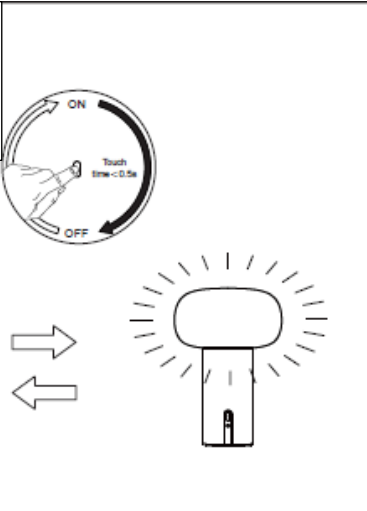
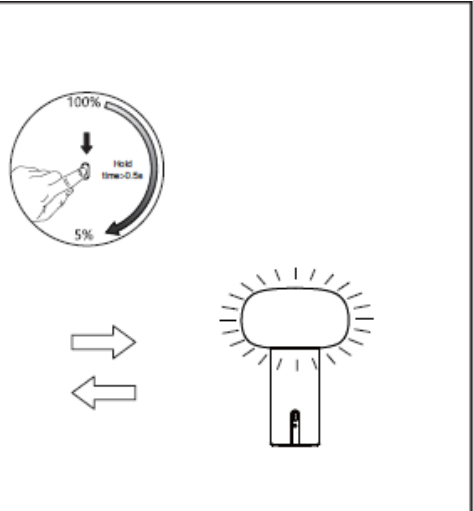
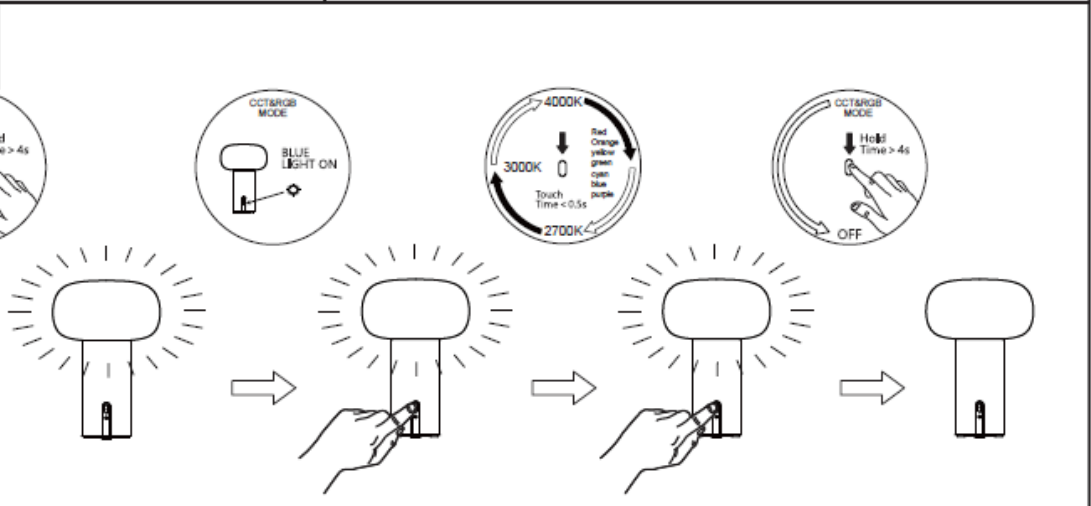

<p>TOUCHKNAPP (PÅ/AV) Memoryfunktion för ljusstyrka. Varje gång du slår på lampan lyser den med samma ljusstyrka som du tidigare ställt in.</p>		<p>STEGLÖS DIMMER Denna funktion är endast tillgänglig när lampan är påslagen.</p>	
<p>FÄRGTEMPERATURKNAPP Denna funktion är endast tillgänglig när lampan är avstängd.</p>			

Dieter Knoll Collection

92300005/01 92300005/04
92300005/02 92300005/05
92300005/03



Lampen stänger automatiskt av färgtemperaturomkoppling släget om det inte sker någon åtgärd inom 10 sekunder.

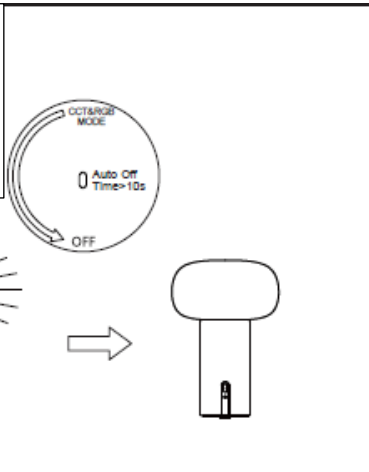

LADDA APPARATEN

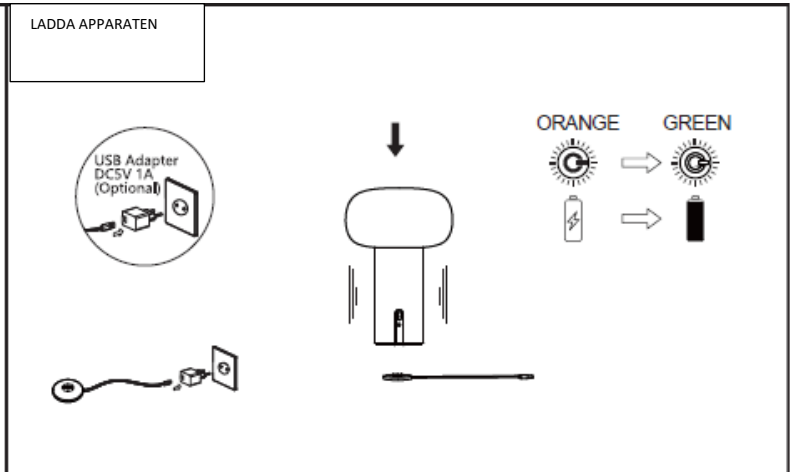

ORANGE GREEN

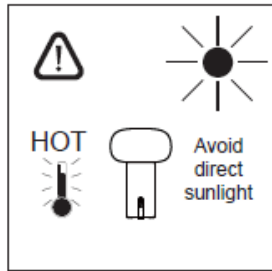

HOT Avoid direct sunlight

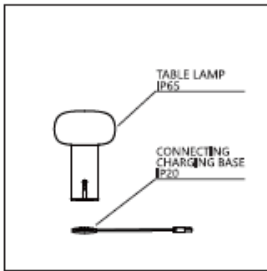

TABLE LAMP IP65
CONNECTING CHARGING BASE IP20

Dieter Knoll Collection

92300005/01 92300005/04
92300005/02 92300005/05
92300005/03



SK:

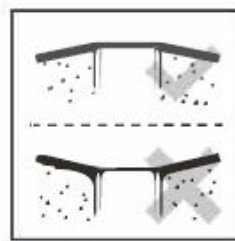
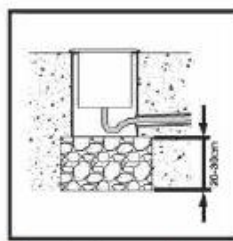
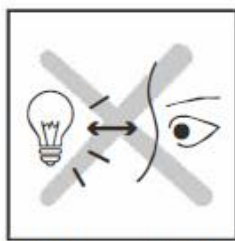
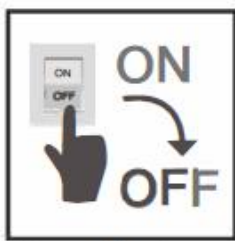

<p>Pripojenie a údržbu svietidla smie vykonávať len vyškolený a kvalifikovaný odborný personál v súlade s platnými predpismi.</p>	<p>Pred vykonaním údržby sa uistite, že je svietidlo odpojené od elektrickej siete.</p>	<p>Riziková skupina LED 0-1, norma: IEC 62471. Nepozerajte sa priamo do svetelného zdroja, keď je v prevádzke. Môže to spôsobiť poškodenie zraku.</p>	<p>Umiestnite svietidlo zapustené do zeme na 20-30 cm hrubú drenážnu vrstvu (štrk) a naplňte ju vodou. Ak voda po 30 minútach úplne neodtečie, musíte nainštalovať ďalší drenážny systém (napr. odtokové potrubie).</p>	<p>Aby sa zabránilo hromadeniu vody, nesmie sa zapustené svietidlo inštalovať do prieliachiny.</p>
---	---	---	---	--

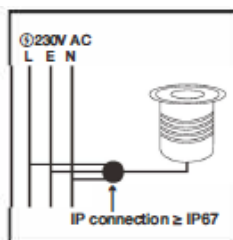
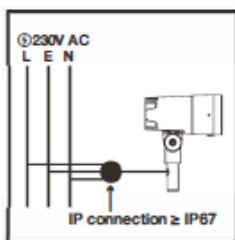
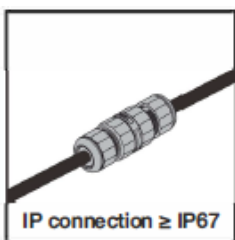
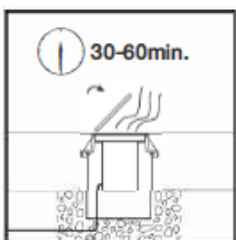

<p>Ak demontujete zapustené svietidlá, projektory alebo stípičky, zapnite ich pred demontážou na 30 až 60 minút, aby sa mohla odparovať prípadná vlhkosť.</p>	<p>Elektrické pripojenie svietidiel s pripojovacím káblom z výroby musí spĺňať minimálne stupeň ochrany IP67.</p>	<p>Elektrické pripojenie projektorov musí spĺňať minimálne stupeň ochrany IP67.</p>	<p>Elektrické pripojenie zapustených svietidiel musí spĺňať minimálne stupeň ochrany IP67.</p>	<p>Všetky svietidlá sú vybavené tesniacim systémom, ktorý poskytuje účinnú ochranu proti vniknutiu vody a vlhkosti pozdĺž pripojovacích káblov.</p>
---	---	---	--	---

Dieter Knoll Collection

92300005/01 92300005/04
92300005/02 92300005/05
92300005/03



Ak sa poškodí vonkajší ohybný kábel svietidla, môže ho vymeniť len výrobca alebo kvalifikovaná osoba, aby sa predišlo nebezpečenstvu.

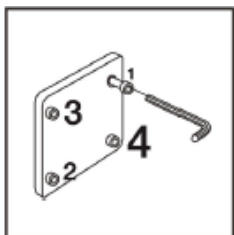

Skrutky uťahujte striedavo alebo do kríža. Rovnako postupujte aj pri uvoľňovaní skrutiek.



Pre jednoduchú údržbu (odskrutkovanie) svietidla odporúčame závit skrutiek pred vystavením svietidla poveternostným vplyvom chrániť silikónovým mazivom.



Svietidlo udržiavajte čisté, aby sa na ráme a skrutkách nehromadili nečistoty. Používajte len čistiace prostriedky špeciálne určené na komponenty z ušľachtilej ocele.



Svietidlo nevystavujte pôsobeniu agresívnych prostriedkov alebo chemických látok (napr. hnojív, prostriedkov na ničenie buriny, vápna).



Nepoužívajte vysokotlakové čističe.

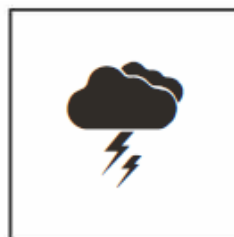

Idete o elektronické zariadenie, ktoré je citlivé na prepätie. Inštalácia prepäťovej ochrany znižuje intenzitu prepätia a chráni zariadenia pred poškodením.

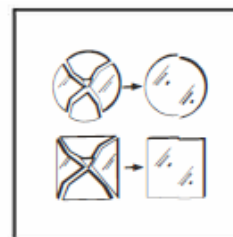

Ak je difúzor poškodený, vymeňte ho pred zapnutím svietidla.



Tento návod uschovajte, aby ste si ho neskôr v prípade potreby mohli opätovne prečítať.

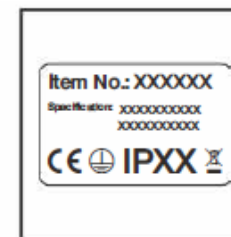

Technické údaje sú uvedené na typovom štítku výrobku.

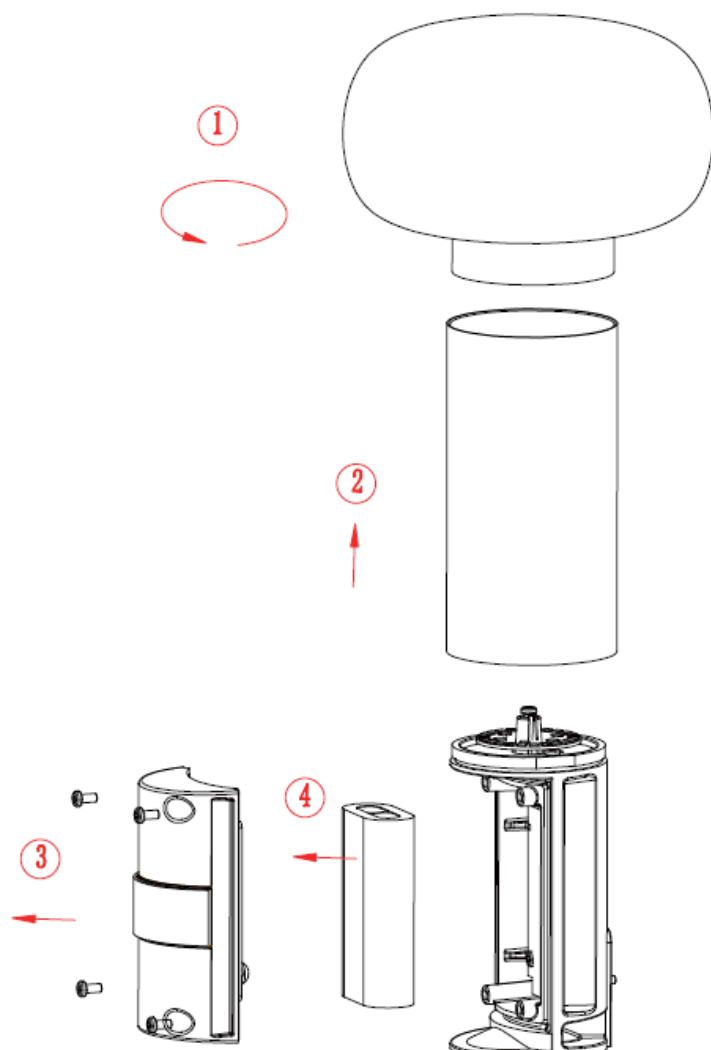

Demontáž LED modulu:

Pred demontážou svetidlo odpojte od elektrickej siete.

1: odskrutkujte sklenený kryt proti smeru hodinových ručičiek.

2: vyberte hliníkovú trubicu smerom nahor.

3: Odstráňte skrutky krycej dosky

4: vyberte batérie

Tento výrobok obsahuje niekoľko svetelných zdrojov triedy energetickej účinnosti G.

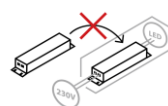

Predradník nie je možné vymeniť.

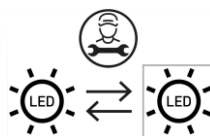

LED svetelný zdroj musí vymeniť odborník.

Dieter Knoll Collection

92300005/01 92300005/04
92300005/02 92300005/05
92300005/03



**DOTYKOVÝ SPÍNAČ
(ZAPNUTIE/VYPNUTIE)**
Pamäťová funkcia jasú: Po každom zapnutí sa lampa rozsvieti s jasom, ktorý bol naposledy nastavený.

PLYNULÉ STMIEVANIE
Táto funkcia je k dispozícii len vtedy, keď je svetlo zapnuté.

SPÍNAČ NA NASTAVENIE FAREBNEJ TEPLŔTY
Táto funkcia je k dispozícii len vtedy, keď je svetlo vypnuté.

Dieter Knoll Collection

92300005/01 92300005/04
92300005/02 92300005/05
92300005/03



Keď do desiatich sekúnd
neaktivujete žiadnu
funkciu, lampa
automaticky vypne režim
zmeny farebnej teploty.

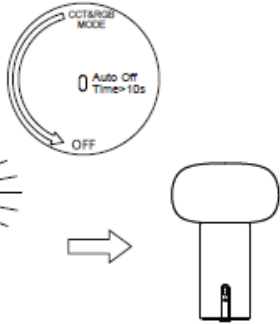

NABÚJANIE LAMPY

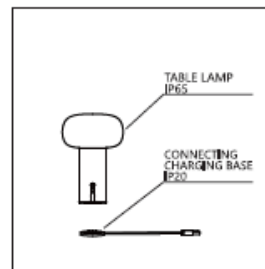
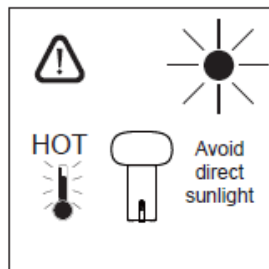
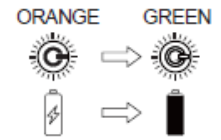
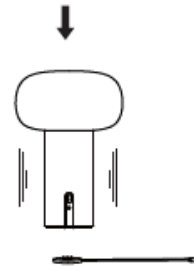

Dieter Knoll Collection

92300005/01 92300005/04
92300005/02 92300005/05
92300005/03



SI:

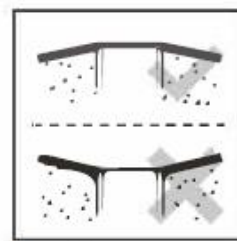
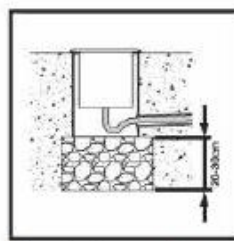
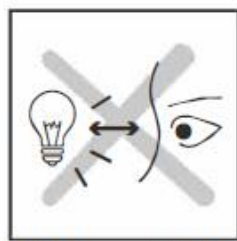
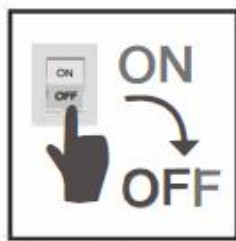

<p>Priključitev in vzdrževanje svetilke lahko izvaja le usposobljeno in kvalificirano strokovno osebje v skladu z veljavnimi predpisi.</p>	<p>Pred izvajanjem vzdrževalnih del se prepričajte, da je svetilka odklopljena iz električnega omrežja.</p>	<p>Skupina tveganja LED 0–1, norma: IEC 62471 Med delovanjem ne glejte neposredno v vir svetlobe. To lahko vodi do poškodb vida.</p>	<p>Talno vgradno svetilko postavite na 20–30 cm debelo drenažno plast (prod) in jo napolnite z vodo. Če voda po 30 minutah ni popolnoma odtekla, morate namestiti dodaten sistem za odvajanje vode (npr. odtočno cev).</p>	<p>Da bi preprečili nabiranje vode, talne vgradne svetilke ne smete namestiti v vdolbino.</p>
--	---	--	--	---

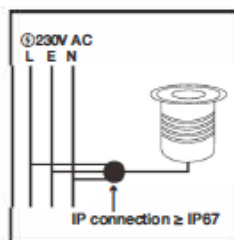
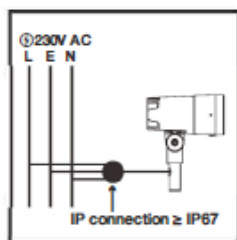
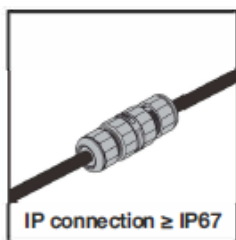
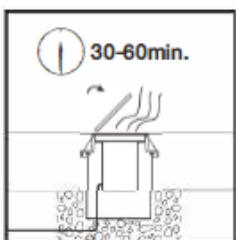

<p>Če razstavljate vgrajene talne svetilke, projektorje ali stebričke, jih pred tem vklopite za 30–60 minut, da iz njih izhlapi vlaga.</p>	<p>Električni priključek svetil s tovarniško napeljanim priključnim kablom mora ustrezati najmanj zaščitnemu razredu IP67.</p>	<p>Električni priključek projektorjev mora ustrezati najmanj zaščitnemu razredu IP67.</p>	<p>Električni priključek talnih vgradnih svetilk mora ustrezati najmanj zaščitnemu razredu IP67.</p>	<p>Vse svetilke so opremljene s tesnilnim sistemom, ki zagotavlja učinkovito zaščito pred vdorom vode in vlage vzdolž priključnih kablov.</p>
--	--	---	--	---

Dieter Knoll Collection

92300005/01 92300005/04
92300005/02 92300005/05
92300005/03

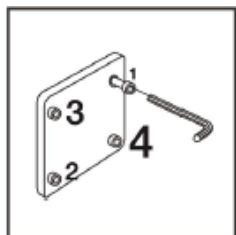

Če je poškodovan zunanji fleksibilni kabel svetilke, ga sme zamenjati izključno proizvajalec ali kvalificirana oseba, da se izogne nevarnostim.

Vijake zategujte izmenično ali prečno. Enako ravnajte pri odvijanju vijakov.

Za lažje vzdrževanje (odvijanje) svetilke priporočamo, da pred izpostavljanjem svetilke vremenskim vplivom vijake navoje zaščitite s silikonsko mastjo.

Svetilko vzdržujte čisto, da se na okvirju in vijakih ne nabere umazanija. Za nego sestavnih delov iz nerjavečega jekla uporabljajte samo posebna čistila, ki so za to namenjena.

Svetilke ne izpostavljajte agresivnim sredstvom ali kemičnim snovem (npr. gnojilom, sredstvom za zatiranje plevela, apnu).

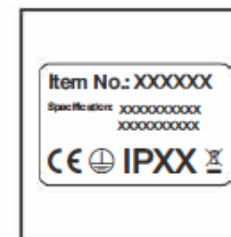
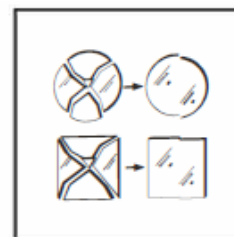

Ne uporabljajte visokotlačnega čistilca.

Gre za elektronsko napravo, ki je občutljiva na prenapetost. Namestitev prenapetostne zaščite ublaži jakost prenapetostnih udarov in ščiti naprave pred poškodbami.

Če je difuzor poškodovan, ga pred vklopom svetilke zamenjajte.

Ta navodila shranite.

Tehnični podatki so navedeni na tipski tablici izdelka.

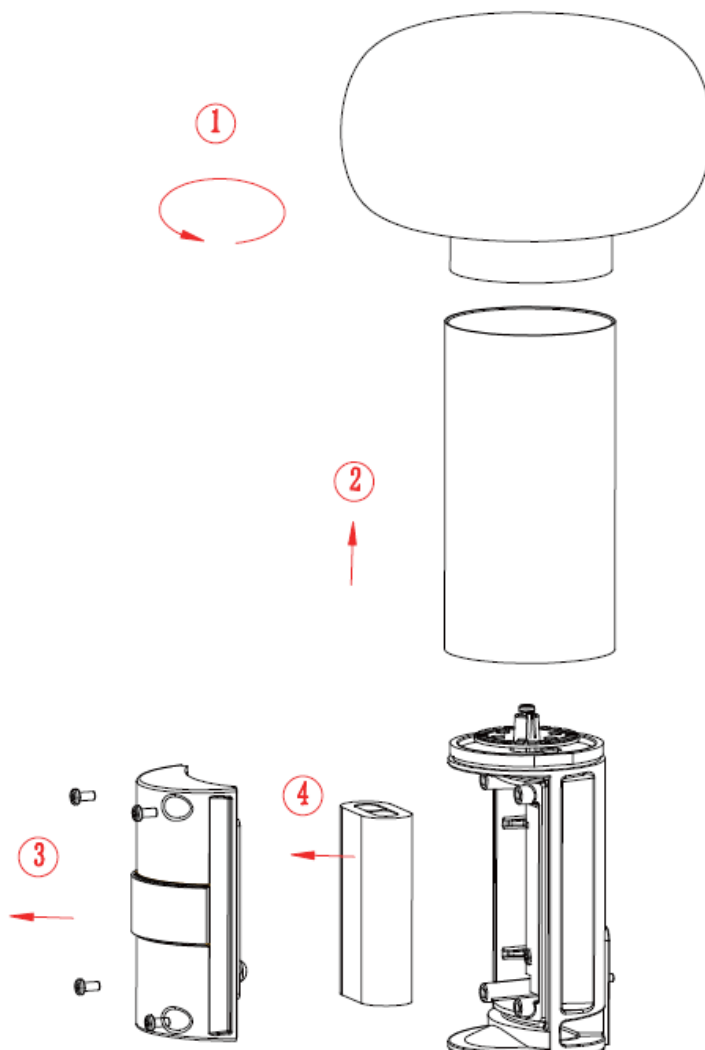

Demontaža LED-modula

Preden svetilko razstavite, jo odklopite iz električnega omrežja.

1: odvijte stekleni pokrov v nasprotni smeri urnega kazalca.

2: odstranite aluminijasto cev navzgor.

3: Odstranite vijake pokrovne plošče

4: odstranite baterije

Ta izdelek vsebuje več svetlobnih virov razreda energijske učinkovitosti: G

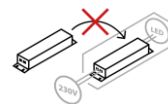

Krmilne naprave ni možno zamenjati.

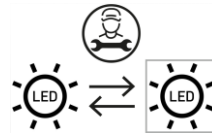

Zamenjava svetlobnega vira LED s strani usposobljene osebe.

Dieter Knoll Collection

92300005/01 92300005/04
92300005/02 92300005/05
92300005/03



Svetilka samodejno izklopi način menjave barvne temperature, če v 10 sekundah ne pritisnete nobenega gumba.

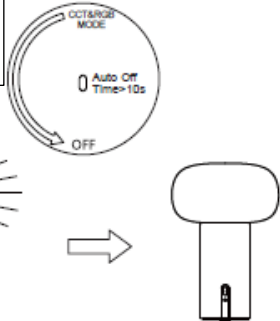

POLNENJE NAPRAVE

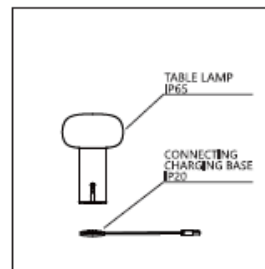
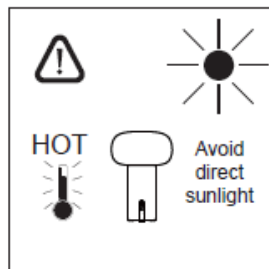
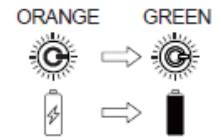
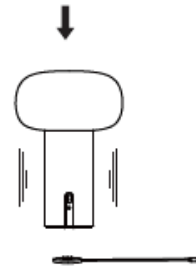

Dieter Knoll Collection

92300005/01 92300005/04
92300005/02 92300005/05
92300005/03



HU:

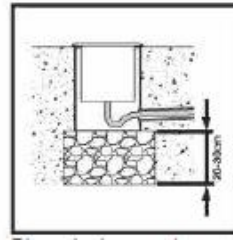
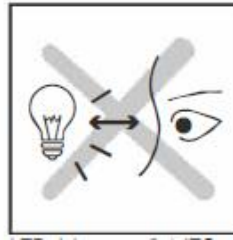
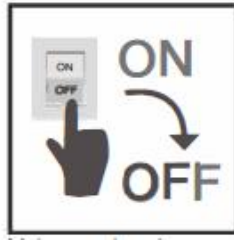

<p>A lámpa csatlakoztatását és karbantartását csak képzett szakemberek végezhetik a vonatkozó előírásoknak megfelelően.</p>	<p>A karbantartási munkálatok elvégzése előtt győződjön meg arról, hogy a lámpa le van választva az áramellátásról.</p>	<p>LED kockázati csoport: 0-1, norma: IEC 62471 Működés közben ne nézzen közvetlenül a fénybe. Ez látáskárosodáshoz vezethet.</p>	<p>Helyezze a talajba süllyeszthető lámpát egy 20-30 cm vastag vízelvezető rétegre (kavicsra), és töltsse fel vízzel. Ha a víz 30 perc elteltével sem folyik le teljesen, kiegészítő vízelvezető rendszert (pl. lefolyócsövet) kell beépíteni.</p>	<p>A víz felgyülemelésének megakadályozása érdekében a talajba süllyeszthető lámpát nem szabad mélyedésbe szerelni.</p>
---	---	---	--	---

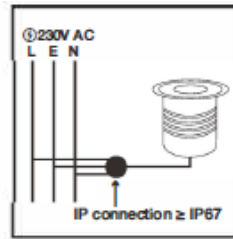
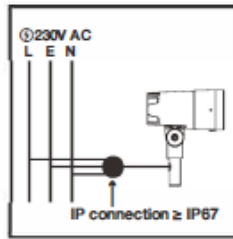
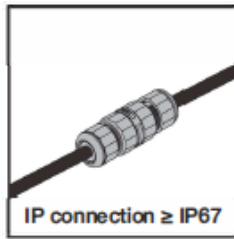
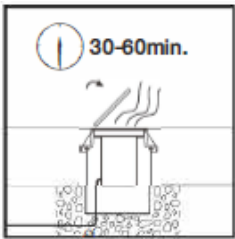

<p>Ha talajba süllyeszthető lámpákat, projektorokat vagy oszloplámpákat szerel le, előtte kapcsolja be őket 30-60 percre, hogy a nedvesség elpárologhasson.</p>	<p>A gyárilag csatlakozókábellel ellátott lámpák elektromos csatlakozójának legalább az IP67 védetségnek meg kell felelnie.</p>	<p>A projektorok elektromos csatlakozójának legalább az IP67 védetségnek meg kell felelnie.</p>	<p>A talajba süllyeszthető lámpák elektromos csatlakozójának legalább az IP67 védetségnek meg kell felelnie.</p>	<p>Minden lámpa tömítőrendszerrel van felszerelve, amely hatékony védelmet nyújt a csatlakozókábelek mentén beható víz és nedvesség ellen.</p>
---	---	---	--	--

Dieter Knoll Collection

92300005/01 92300005/04
92300005/02 92300005/05
92300005/03



A veszélyek elkerülése érdekében a külső, rugalmas kábelt sérülés esetén csak a gyártó vagy egy képzett személy cserélheti ki.

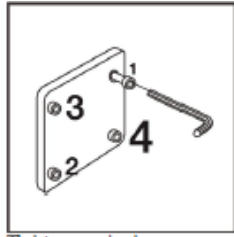

Húzza meg a csavarokat felváltva vagy keresztben. Ugyanígy járjon el a csavarok meglazításakor is.



A lámpa egyszerű karbantartása (kicsavarása) érdekében javasoljuk, hogy a csavarmeneteket szilikonszírral védje, mielőtt a lámpát kitenné az időjárásnak.



Tartsa tisztán a lámpát, hogy ne rakódjanak szennyeződések a keretre és a csavarokra. Csak kifejezetten rozsdamentes acél alkatrészekhez való tisztítószeret használjon.



Ne tegye ki a lámpát agresszív szereknek vagy vegyi anyagoknak (pl. műtrágya, gyomirtók, mész).



Ne használjon magasnyomású tisztítót.

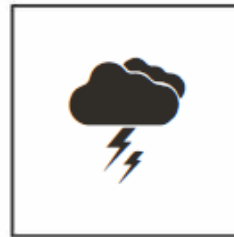

Ez egy olyan elektromos készülék, amely érzékenyen reagál a túlfeszültségre. A túlfeszültség-védelem telepítése csökkenti a túlfeszültség intenzitását, és megvédi az eszközöket a károsodástól.

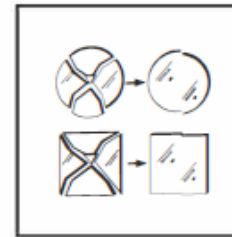

Ha a diffúzor megsérült, cserélje ki, mielőtt bekapcsolja a lámpát.



Őrizze meg a használati utasítást.

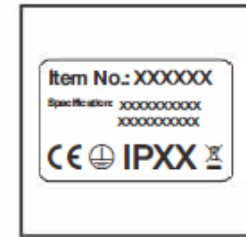

A műszaki adatok a termék típusabláján találhatóak.

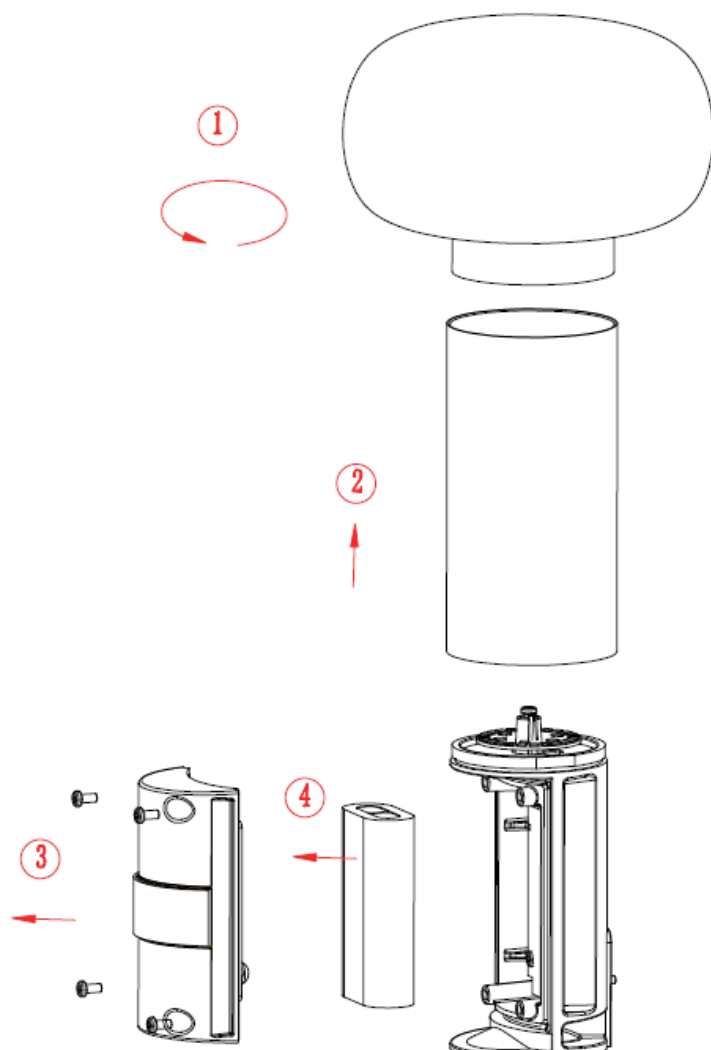

A LED modul szétszerelése:

Válassza le a lámpát a hálózatról, mielőtt szétszereli.

1: csavarja le az üvegfedelelet az óramutató járásával ellentétes irányba.

2: távolítsa el az alumínium csövet felfelé.

3: Távolítsa el a fedőlap csavarjait

4: vegye ki az elemeket

A lámpa a következő energiasztályú izzókat tartalmazza: G

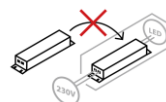

Működtető eszköz nem cserélhető.

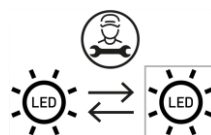

A LED izzót szakemberrel cseréltesse ki.

Dieter Knoll Collection

92300005/01
92300005/02
92300005/03

92300005/04
92300005/05



ÉRINTŐKAPCSOLÓ (BE/KI)
Memória funkció a fényerőhöz. Minden alkalommal, amikor bekapcsolja a lámpát, az utoljára beállított fényerővel világít.

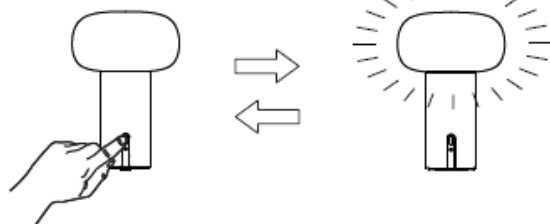
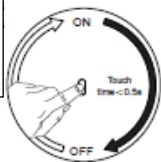

FOKOZATMENTES TOMPÍTÁS
Ez a funkció csak a lámpa bekapcsolása után érhető el.

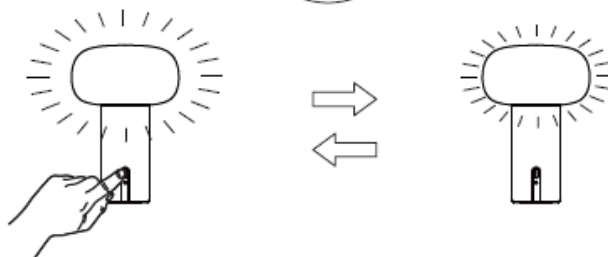
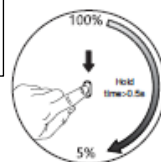

SZÍNHŐMÉRSÉKLET-KAPCSOLÓ
Ez a funkció csak a lámpa kikapcsolása után érhető el.

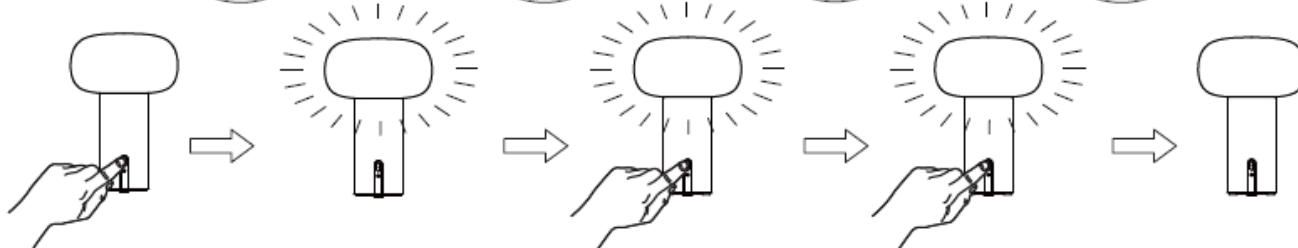
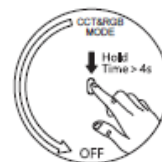
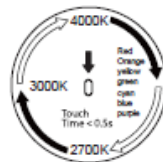
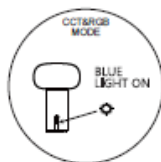
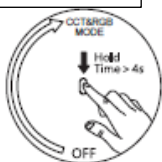

Dieter Knoll Collection

92300005/01 92300005/04
92300005/02 92300005/05
92300005/03



A lámpa automatikusan kikapcsolja a színhőmérséklet beállítási üzemmódot, ha 10 másodpercen belül nem módosít rajta.

A KÉSZÜLÉK TÖLTÉSE

ORANGE GREEN

Auto Off Time=10s

USB Adapter DC5V 1A (Optional)

TABLE LAMP IP65

CONNECTING CHARGING BASE EP20

HOT

Avoid direct sunlight

Dieter Knoll Collection

92300005/01 92300005/04
92300005/02 92300005/05
92300005/03



HR:

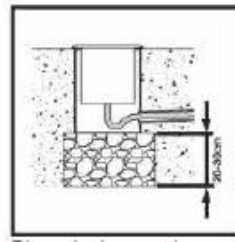
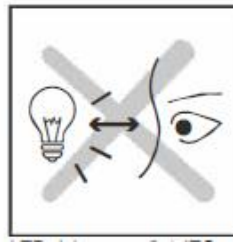
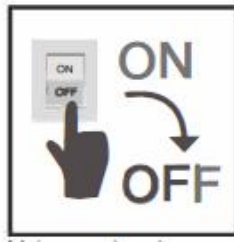

<p>Priključak i održavanje svjetiljke smije izvršiti samo educirana i kvalificirana stručna osoba, u skladu s primjenjivim propisima.</p>	<p>Prije održavanja osigurajte da je svjetiljka isključena iz električne mreže.</p>	<p>Rizična skupina LED 0 - 1, norma: IEC 62471 Ne gledajte izravno u izvor svjetlosti dok je uključen. To može dovesti do oštećenja vida.</p>	<p>Postavite ugradbenu podnu svjetiljku na drenažni sloj (šljunak) debljine od 20 do 30 cm i napunite ga vodom. Ako voda ne oteče u potpunosti nakon 30 minuta, morate ugraditi dodatni drenažni sustav (npr. odvodnu cijev).</p>	<p>Ugradbena podna svjetiljka ne smije se instalirati u udubljenje kako se ne bi nakupljala voda.</p>
---	---	---	---	---

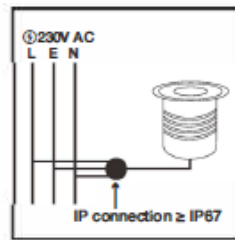
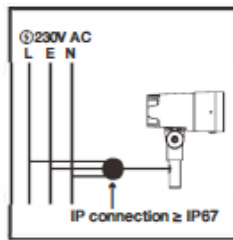
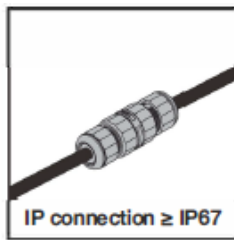
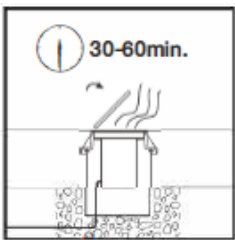

<p>Ako demontirate ugradbene podne svjetiljke, projektore ili stupne svjetiljke, isključite svjetiljke 30 - 60 minuta prije demontaže kako bi isparila eventualna vlaga.</p>	<p>Električni priključak svjetiljki s tvornički spojenim priključnim kabelom mora zadovoljavati najmanje stupanj zaštite IP67.</p>	<p>Električni priključak projektora mora zadovoljavati najmanje stupanj zaštite IP67.</p>	<p>Električni priključak ugradbenih podnih svjetiljki mora zadovoljavati najmanje stupanj zaštite IP67.</p>	<p>Sve su svjetiljke opremljene sustavom brtvljenja koji pruža učinkovitu zaštitu od prodiranja vode i vlage uzduž priključnih kabela.</p>
--	--	---	---	--

Dieter Knoll Collection

92300005/01 92300005/04
92300005/02 92300005/05
92300005/03

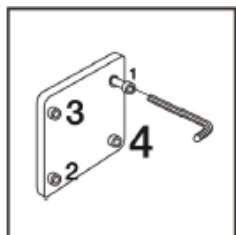

Ako je vanjski, fleksibilni kabel svjetiljke oštećen, zamjenu smije izvršiti isključivo proizvođač ili slično kvalificirana osoba kako biste izbjegli opasnosti.

Pritegnite vijke naizmjenično ili unakrsno. Na isti način postupajte pri otpuštanju vijaka.

Za jednostavno održavanje (odvijanje) svjetiljke preporučuje se da navoje vijaka zaštitite silikonskom mašću prije nego što svjetiljku izložite vremenskim uvjetima.

Držite svjetiljku čistom kako biste izbjegli nakupljanje prljavštine na okviru i vijcima. Za čišćenje dijelova od oplemenjenog čelika koristite isključivo specijalno predviđena sredstva za čišćenje.

Ne izlažite svjetiljku agresivnim sredstvima ili kemijskim tvarima (npr. gnojivu, herbicidima, vapnu).

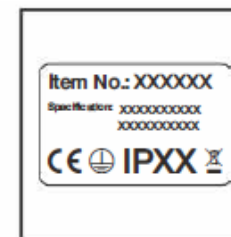
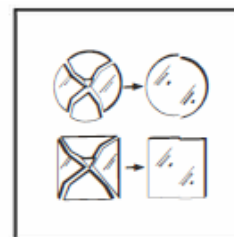

Ne koristite visokotlačne čistilice.

Ovdje je riječ o elektroničkom uređaju koji osjetljivo reagira na prenapon. Instalacija prenaponske zaštite ublažava intenzitet prenaponskih udara i štiti uređaje od oštećenja.

Ako je difuzor oštećen, zamijenite ga prije uključivanja svjetiljke.

Spremite ove upute za kasniju uporabu.

Tehnički podaci navedeni su na tipskoj pločici proizvoda.

Demontaža LED modula

Prije rastavljanja isključite svjetiljku iz električne mreže.

1: odvrnite stakleni poklopac u smjeru suprotnom od kazaljke na satu.

2: uklonite aluminijsku cijev prema gore.

3: Uklonite vijke pokrovne ploče

4: izvadite baterije

Ovaj proizvod sadrži više izvora svjetlosti razreda energetske učinkovitosti: G

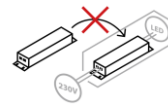

Upravljački uređaj nije zamjenjiv.

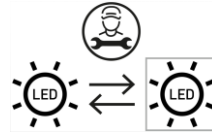

Zamjena LED izvora svjetlosti od strane stručne osobe.

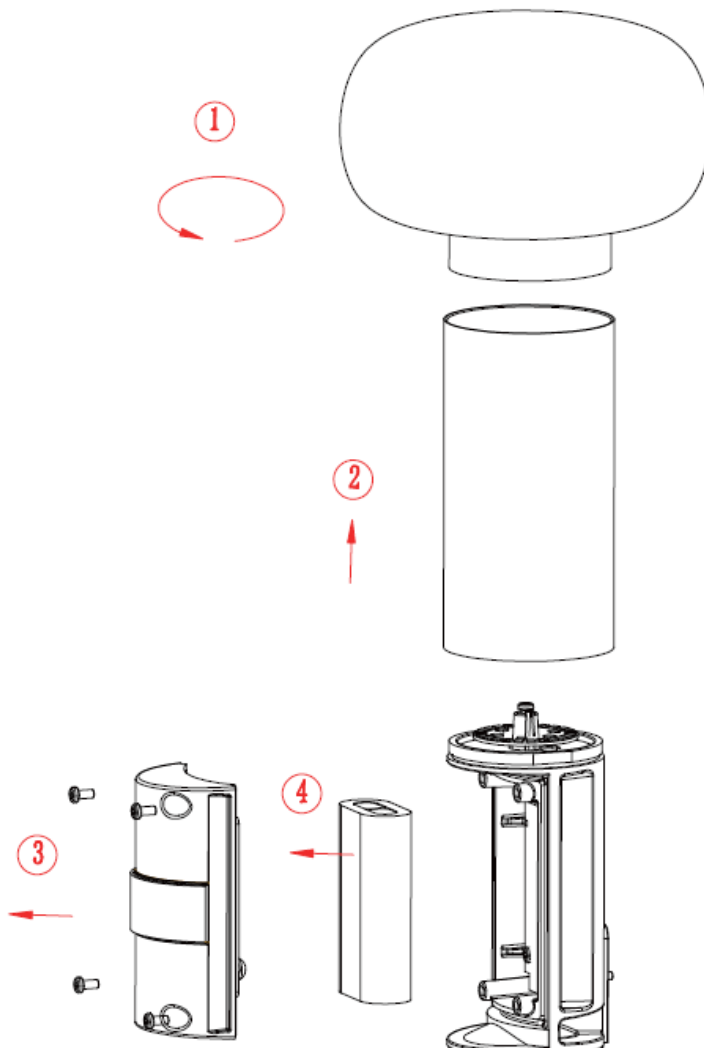

Dieter Knoll Collection

92300005/01
92300005/02
92300005/03

92300005/04
92300005/05



**DODIRNI PREKIDAČ
(UKLJ/ISKLJ)**
Memory funkcija za svjetlinu.
Svaki put kada ju uključite,
svjetiljka će svijetliti
prethodno podešenom
svjetlinom.

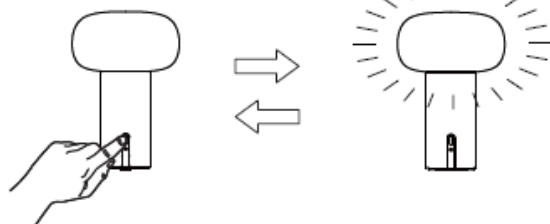
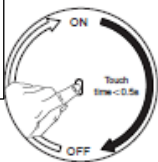

NESTUPNJEVITO PRIGUŠIVANJE
Ova je funkcija dostupna samo, ako je
svjetiljka uključena.

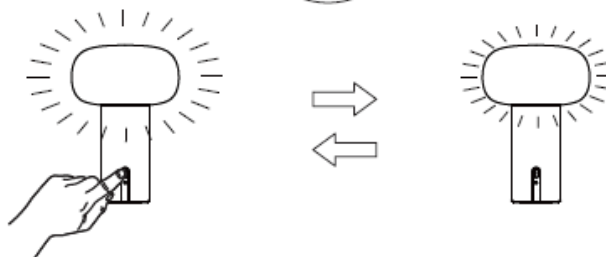
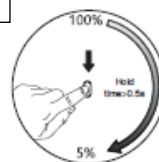

PREKIDAČ ZA TEMPERATURU BOJE
Ova je funkcija dostupna samo, ako je
svjetiljka isključena.

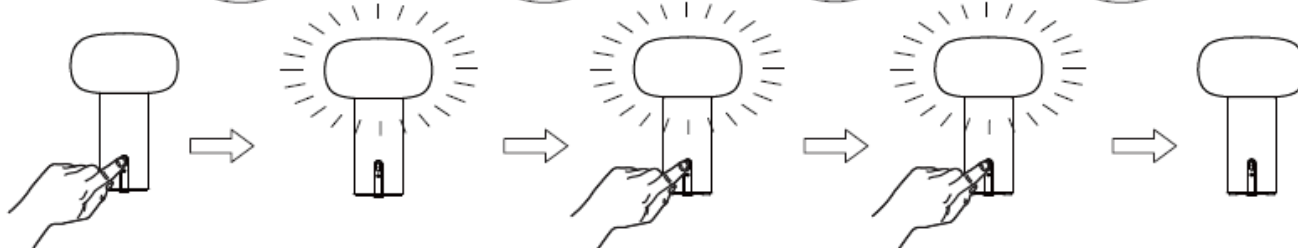
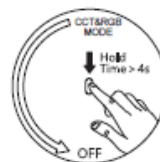
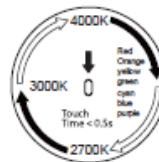
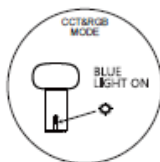
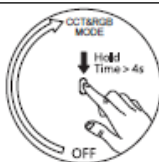

Dieter Knoll Collection

92300005/01 92300005/04
92300005/02 92300005/05
92300005/03



Svjetiljka automatski isključuje mod prebacivanja temperature boje, ako unutar 10 sekundi ništa ne pritisnete.

PUNJENJE UREĐAJA

Auto Off Time=10s

ORANGE GREEN

USB Adapter DC5V 1A (Optional)

TABLE LAMP IP65

CONNECTING CHARGING BASE E20

HOT Avoid direct sunlight

Dieter Knoll Collection

92300005/01 92300005/04
92300005/02 92300005/05
92300005/03



BG:

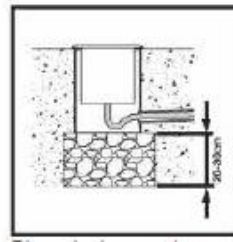
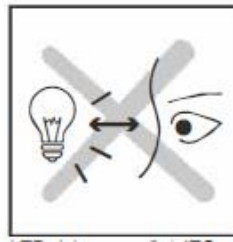

<p>Свързването и поддръжката на лампата могат да се извършват само от обучен и квалифициран специализиран персонал в съответствие с приложимите разпоредби.</p>	<p>Уверете се, че лампата е изключена от електрическото захранване, преди да извършвате дейности по поддръжка.</p>	<p>LED рискова група 0–1, норма: IEC 62471 Не гледайте директно в източника на светлина, когато той работи. Това може да доведе до увреждане на очите.</p>	<p>Поставете лампата за вграждане в земята върху дренажен слой (чакъл) с дебелина 20-30 см и налейте вода. Ако след 30 минути водата не се е отцедила напълно, трябва да монтирате допълнителна дренажна система (напр. дренажна тръба).</p>	<p>За да се предотврати натрупването на вода, лампата за вграждане в земята не трябва да се монтира във вдлъбнатина.</p>
---	--	--	--	--

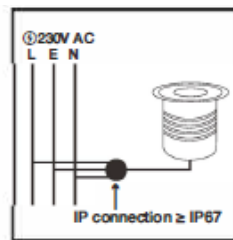
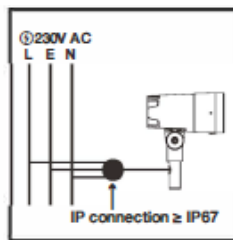
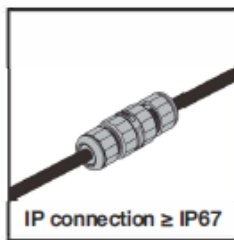
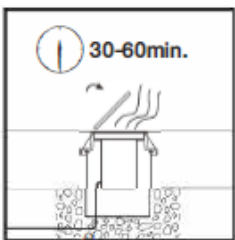

<p>Ако демонтирате лампи за вграждане в земята, проектори или антипаркинг колчета, включете лампите за 30-60 минути преди демонтажа, за да се изпари евентуално наличната влагата.</p>	<p>Електрическото свързване на лампите с фабрично монтиран свързващ кабел трябва да отговаря най-малко на степен на защита IP67.</p>	<p>Електрическото свързване на проекторите трябва да отговаря най-малко на степен на защита IP67.</p>	<p>Електрическото свързване на лампи за вграждане в земята трябва да отговаря най-малко на степен на защита IP67.</p>	<p>Всички лампи са оборудвани с уплътнителна система, която осигурява ефективна защита срещу проникване на вода и влага по свързващите кабели.</p>
--	--	---	---	--

Dieter Knoll Collection

92300005/01 92300005/04
92300005/02 92300005/05
92300005/03

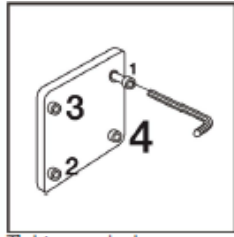

Ако външният гъвкав кабел на лампата е повреден, той трябва да се смени само от производителя или от квалифициран специалист, за да се избегне опасност.

Затягайте винтовете последователно или на кръст. Процедирайте по същия начин, както при отвиване на винтове.

За по-лесна поддръжка (отвиване) на лампата препоръчваме да защитите резбите на винтовете със силиконова смазка, преди лампата да бъде изложена на атмосферни влияния.

Поддържайте лампата, за да предотвратите натрупването на мръсотия по рамката и винтовете. За компоненти от неръждаема стомана използвайте само предвидени специално за тях почистващи средства.

Не излагайте лампата на агресивни агенти или химически вещества (напр. торове, препарати за унищожаване на плевели, вар).

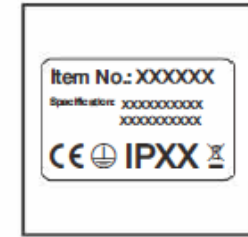
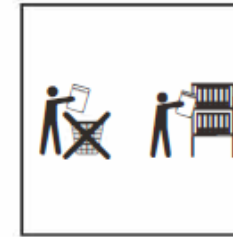
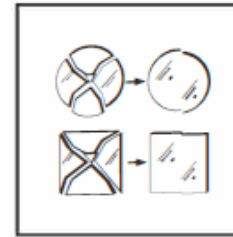
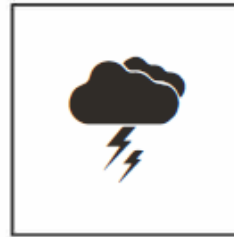

Не използвайте водоструйка под високо налягане.

Това е електронно устройство, което реагира чувствително на свръхнапрежение. Инсталирането на защита от свръхнапрежение намалява интензивността на ударите на свръхнапрежение и предпазва устройствата от повреда.

Ако разсейвателят е повреден, сменете го, преди да включите лампата.

Запазете тези инструкции.

Техническите данни са посочени на табелката на продукта.

Демонтаж на LED модула

Изключете лампата от електрическата мрежа, преди да я разглобите.

- 1: развийте стъкления капак обратно на часовниковата стрелка.
- 2: отстранете алуминиевата тръба нагоре.
- 3: Отстранете винтовете на капака
- 4: извадете батериите

Този продукт съдържа няколко светлинни източника с клас на енергийна ефективност: G

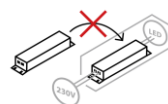

Пусково-регулиращата апаратура не се сменя.

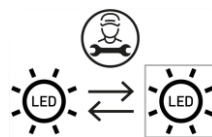

Смяна на LED светлинния източник от специалист.

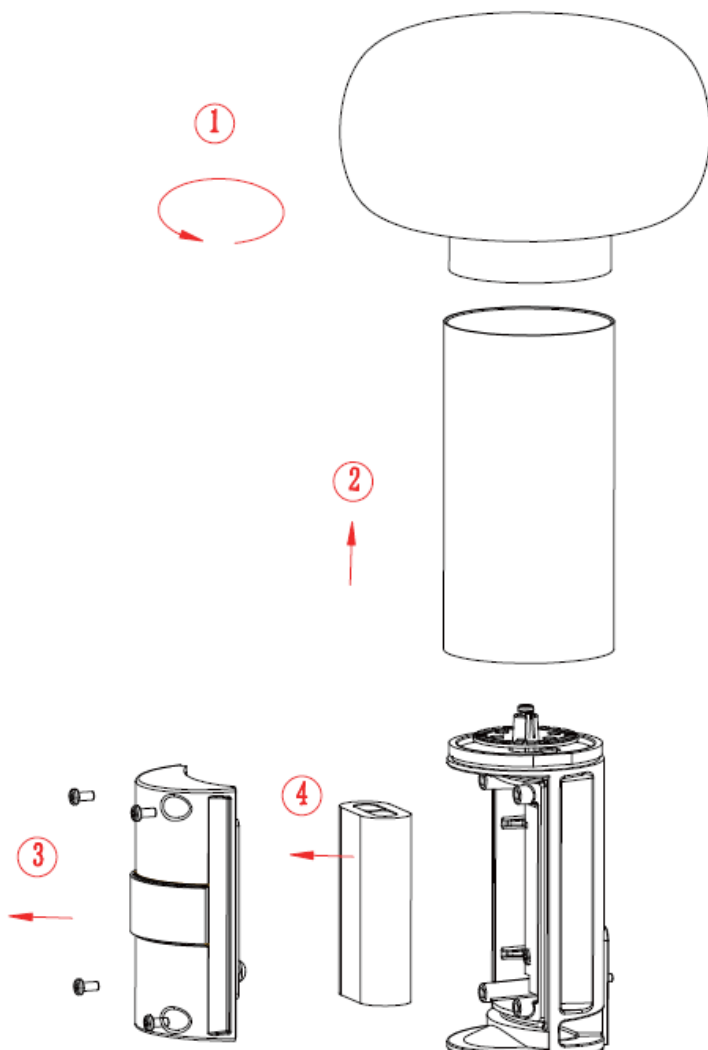

Dieter Knoll Collection

92300005/01
92300005/02
92300005/03

92300005/04
92300005/05



ПРЕВКЛЮЧАТЕЛ С ДОКОСВАНЕ (ВКЛ./ИЗКЛ.)
Функция за запаметяване на яркостта. Всеки път, когато включите лампата, тя светва с последно настроената яркост.

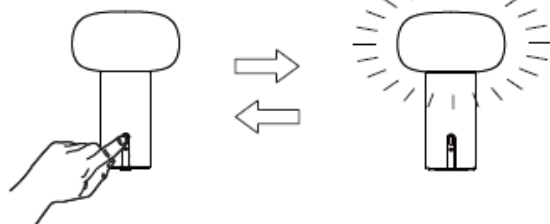
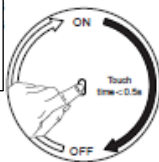

ПЛАВНО ДИМИРАНЕ
Тази функция е достъпна само когато лампата е включена.

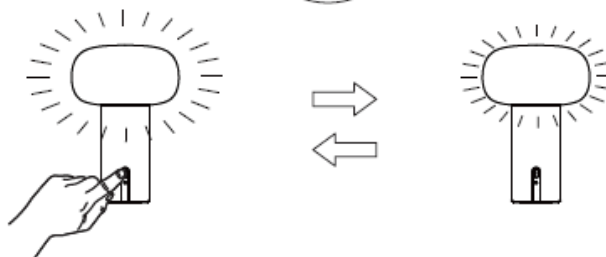
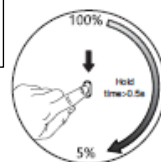

ПРЕВКЛЮЧАТЕЛ ЗА ЦВЕТНА ТЕМПЕРАТУРА
Тази функция е достъпна само когато лампата е изключена.

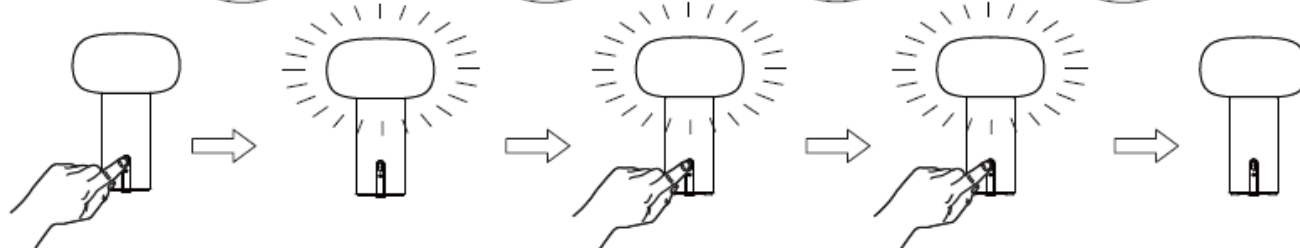
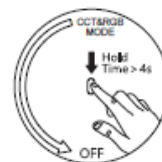
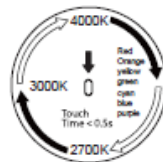
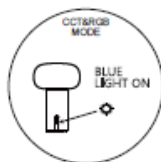
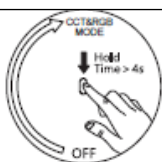

Dieter Knoll Collection

92300005/01 92300005/04
92300005/02 92300005/05
92300005/03



Лампата автоматично изключва режима на превключване на цветната температура, ако в рамките на 10 секунди не се извърши операция.

ОCTANGE MODE
Auto Off Time=10s
OFF

ЗАРЕЖДАНЕ НА УСТРОЙСТВОТО

USB Adapter DC5V 1A (Optional)

ORANGE GREEN

TABLE LAMP IP65
CONNECTING CHARGING BASE E20

HOT Avoid direct sunlight

Dieter Knoll Collection

92300005/01 92300005/04
92300005/02 92300005/05
92300005/03



RO:

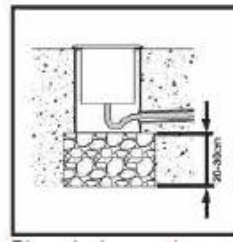
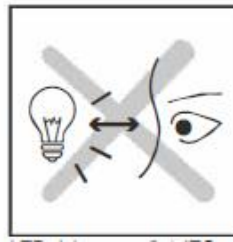

<p>Conectarea și întreținerea lămpii pot fi efectuate numai de către personal specializat, instruit și calificat, în conformitate cu reglementările în vigoare.</p>	<p>Asigurați-vă că lampa este deconectată de la sursa de curent electric înainte de a începe operațiunile de întreținere.</p>	<p>LED-grup de risc 0-1, standard european: IEC 62471 Nu priviți direct în sursa de lumină, atunci când aceasta este pornită. Acest lucru poate provoca probleme de vedere.</p>	<p>Așezați lumina în pământ pe un strat de drenaj de 20-30 cm grosime (pietriș) și turnați apă. Dacă apa nu s-a scurs complet după 30 de minute, trebuie să instalați un sistem de drenaj suplimentar (de exemplu, o țevă de scurgere).</p>	<p>Pentru a preveni acumularea de apă, lumina încastrată în podea nu trebuie instalată pe un teren în pantă.</p>
---	---	---	---	--

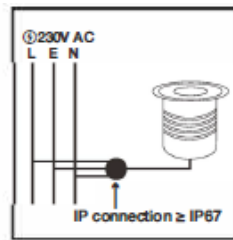
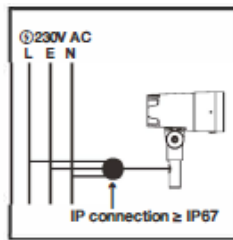
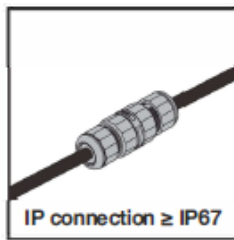
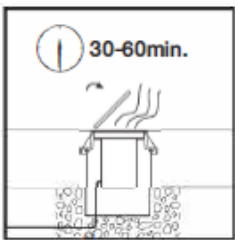

<p>Dacă demontați corpuri de iluminat încastrate în podea, proiectoare sau stâlpi, porniți corpurile de iluminat timp de 30-60 de minute înainte de demontare pentru a permite evaporarea umezelii.</p>	<p>Cuplarea electrică a luminilor cu un cablu de conectare trebuie să respecte cel puțin gradul de protecție IP67.</p>	<p>Cuplarea la sursa de curent electric a proiectoarelor trebuie să respecte cel puțin gradul de protecție IP67.</p>	<p>Cuplarea la sursa de curent electric a corpurilor de iluminat încastrate în podea trebuie să respecte cel puțin gradul de protecție IP67.</p>	<p>Toate corpurile de iluminat sunt echipate cu un sistem de etanșare care asigură o protecție eficientă împotriva pătrunderii apei și a umezelii de-a lungul cablurilor de alimentare.</p>
---	--	--	--	---

Dieter Knoll Collection

92300005/01 92300005/04
92300005/02 92300005/05
92300005/03

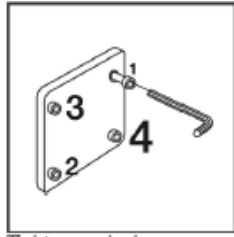

Atunci când cablul de alimentare exterior este deteriorat, acesta trebuie schimbat de către producător sau de către o altă persoană cu o calificare asemănătoare, pentru a evita orice pericol.

Strângeți șuruburile alternativ sau în cruce. Urmați aceeași procedură atunci când slăbiți șuruburile.

Pentru o întreținere ușoară (deșurubare) a corpului de iluminat, vă recomandăm să protejați filetele șuruburilor cu unsoare siliconică înainte ca corpul de iluminat să fie expus la intemperii.

Păstrați lampa curată pentru a preveni acumularea de murdărie pe ramă și pe șuruburi. Utilizați numai agenți de curățare special concepuți pentru componentele din inox.

Nu expuneți lampa la agenți agresivi sau substanțe chimice (de exemplu, îngrășăminte, erbicide, var).

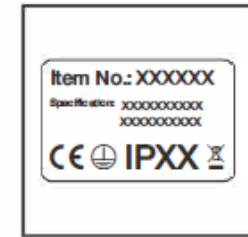
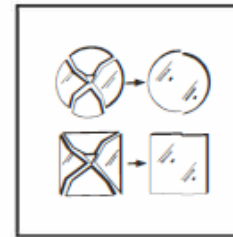

Nu utilizați aparate de curățat cu presiune.

Acesta este un dispozitiv electronic sensibil la supratensiune. Instalarea unei protecții împotriva supratensiunii protejează dispozitivele împotriva deteriorării.

Dacă dispensorul este deteriorat, înlocuiți-l înainte de a porni lumina.

Păstrați aceste instrucțiuni de utilizare.

Datele tehnice sunt menționate pe plăcuța de identificare a produsului.

Demontarea modulului LED:

Deconectați lampa de la rețeaua electrică înainte de a o demonta.

1: deșurubați capacul de sticlă în sens invers acelor de ceasornic.

2: scoateți tubul de aluminiu în sus.

3: Scoateți șuruburile plăcii de acoperire

4: scoateți bateriile

Acest produs conține mai multe surse de iluminat din clasa energetică: G

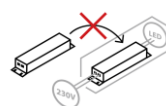

Dispozitivul de comandă nu se poate înlocui.

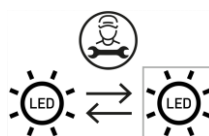

Becul LED trebuie înlocuit de către un profesionist.

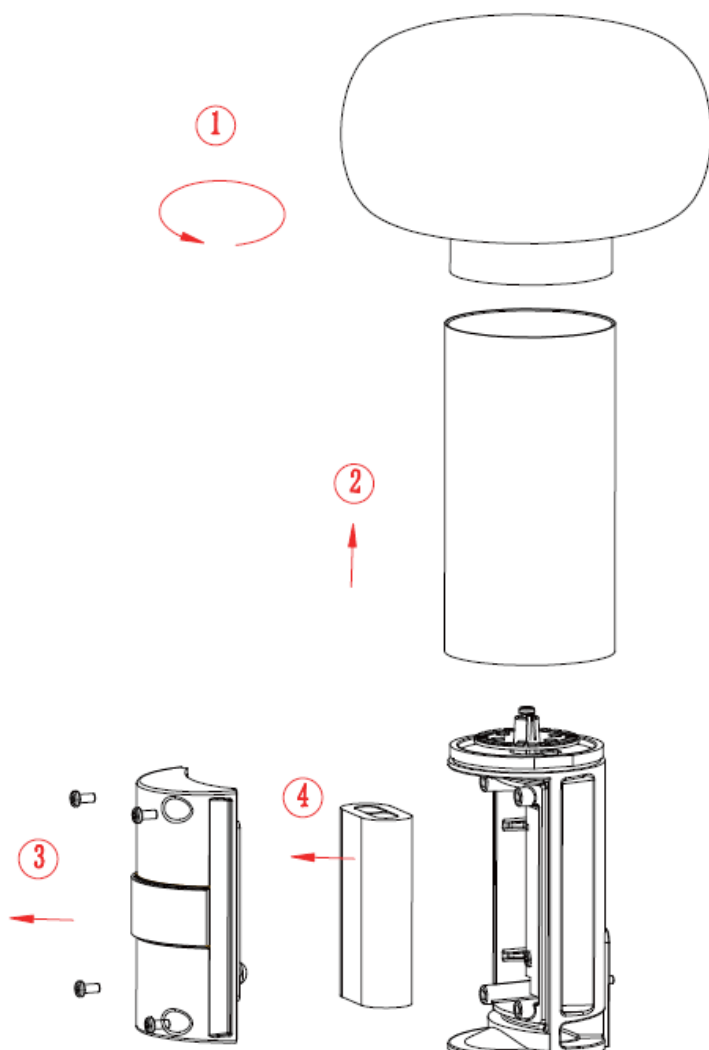

Dieter Knoll Collection

92300005/01
92300005/02
92300005/03

92300005/04
92300005/05



**COMUTATOR TACTIL
(PORNIRE/OPRIRE)**
Funcție de memorie pentru
luminozitate. De fiecare dată
când porniți lampa, aceasta se
aprinde la același nivel de
luminozitate care a fost setat
anterior.

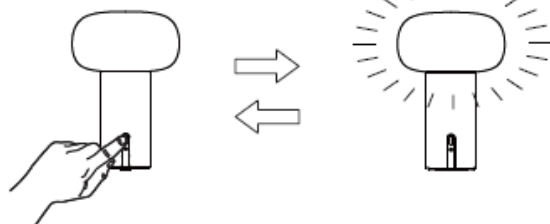
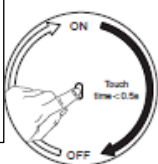

DIMARE CONTINUĂ
Această funcție este disponibilă doar
atunci când lampa este pornită.

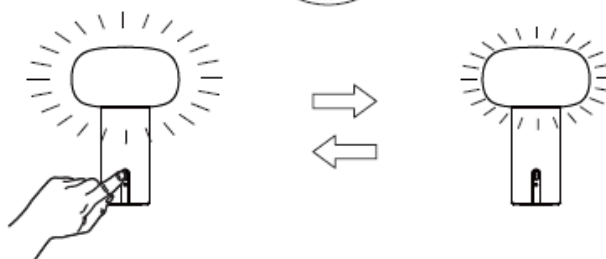
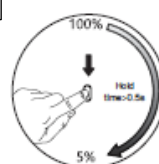

COMUTATOR TEMPERATURĂ CULOARE
Această funcție este disponibilă doar atunci
când lampa este oprită.

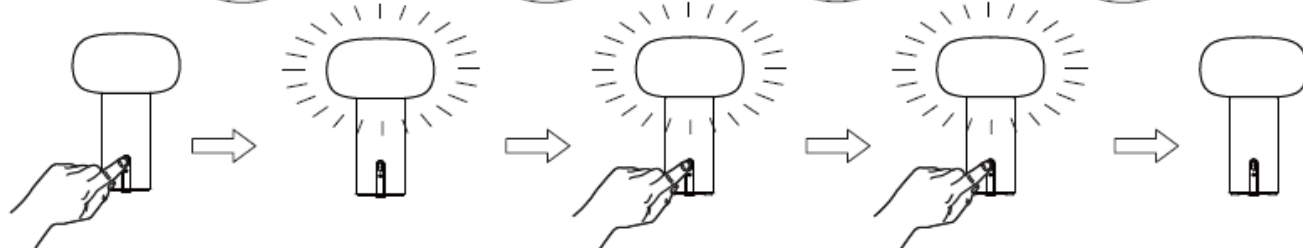
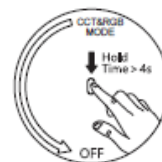
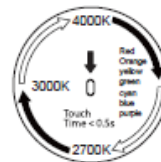
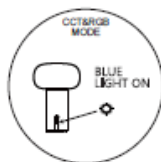
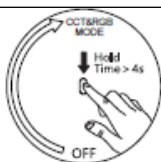

Dieter Knoll Collection

92300005/01 92300005/04
92300005/02 92300005/05
92300005/03



Lumina oprește automat
modul de comutare a
temperaturii de culoare
dacă nu se efectuează
nicio operațiune în decurs
de 10 secunde.

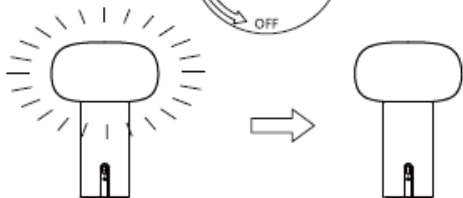
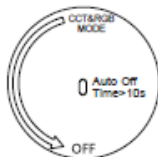

ÎNCĂRCARE DISPOZITIV

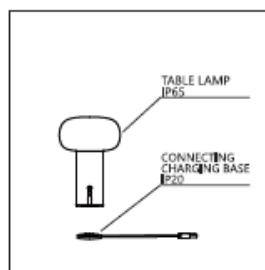
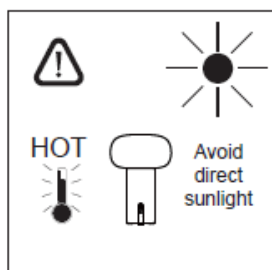
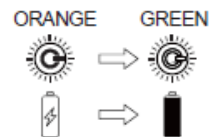
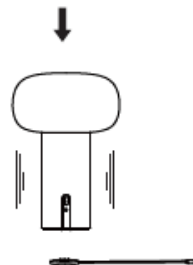

Dieter Knoll Collection

92300005/01 92300005/04
92300005/02 92300005/05
92300005/03



RS:

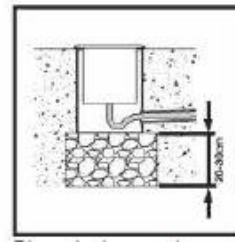
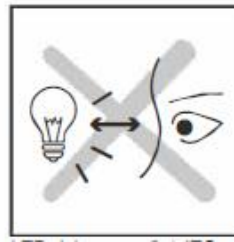
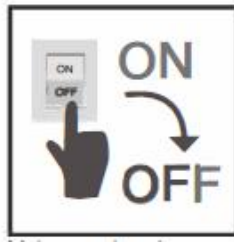

Priključivanje i održavanje lampe sme da obavlja samo obučeno i kvalifikovano stručno osoblje u skladu sa važećim propisima.

Uverite se da je lampa isključena iz struje pre nego što izvršite bilo kakvo održavanje.

LED rizična grupa 0–1, standard: IEC 62471
Ne gledajte direktno u izvor svetlosti kada je u upotrebi. To može izazvati oštećenja očiju.

Postavite ugradnu podnu lampu na drenažni sloj (šljunak) debljine 20–30 cm i napunite vodom. Ako voda nije potpuno ispuštena nakon 30 minuta, moraćete da instalirate dodatni sistem za odvodnjavanje (npr. odvodnu cev).

Da bi se sprečilo nakupljanje vode, ugradna podna lampa ne sme da se postavlja u udubljenje.

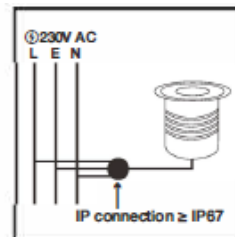
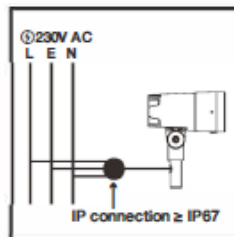
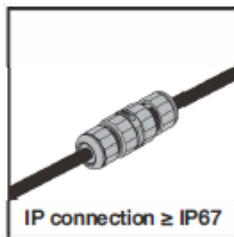
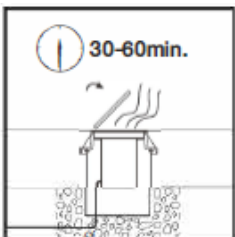

Kada demontirate ugradnu podnu lampu, projektore ili stubove, uključite lampe na 30–60 minuta pre demontaže kako biste dozvolili da eventualna vlaga ispari.

Električno povezivanje lampi sa fabrički ožičenim priključnim kablom mora biti u skladu sa najmanje vrstom zaštite IP67.

Električni priključak projektora mora biti u skladu sa najmanje vrstom zaštite IP67.

Električni priključak ugradnih podnih lampi mora biti u skladu sa najmanje vrstom zaštite IP67.

Sve lampe su opremljene sistemom izolacije koji obezbeđuje efikasnu zaštitu od prodora vode i vlage duž priključnih kablova.

Dieter Knoll Collection

92300005/01 92300005/04
92300005/02 92300005/05
92300005/03

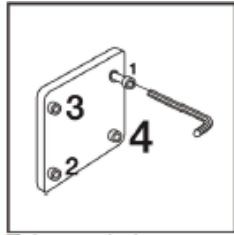

Ukoliko je spoljašni, fleksibilni kabl lampe oštećen, kabl mora zameniti proizvođač ili stručno kvalifikovano osoblje, da bi se izbegle opasnosti.

Zategnite zavrtnje naizmenično ili unakrsno. Sledite isti postupak kada odvrnete zavrtnje.

Radi lakšeg održavanja (odvrtanja) lampe preporučuje se da se navoji zavrtnja zaštite silikonskom mašću pre izlaganja lampe vremenskim uslovima.

Lampu održavajte čistom kako biste sprečili nakupljanje prljavštine na okviru i zavrtnjima. Za delove od nerđajućeg čelika koristite samo sredstva za čišćenje posebno napravljena za delove od nerđajućeg čelika.

Ne izlažite lampu agresivnim sredstvima ili hemijskim supstancama (npr. đubrivo, sredstvo za otklanjanje korova, kreč).

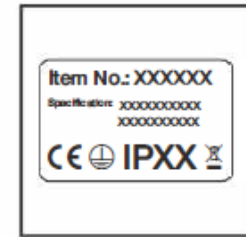
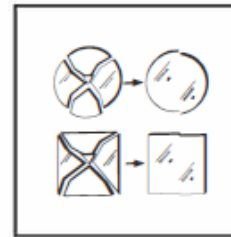
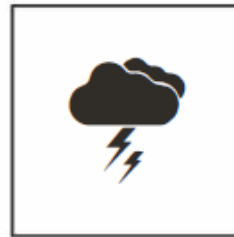

Ne koristite čistač visokog pritiska.

Radi se o elektronskom uređaju koji je osetljiv na prenapon. Instaliranje zaštite od prenapona prigušuje intenzitet prenapona i štiti uređaje od oštećenja.

Ako je difuzor oštećen, zamenite ga pre nego što uključite lampu.

Sačuvajte ova uputstva.

Tehnički podaci su navedeni na tipskoj pločici proizvoda.

Demontaža LED modula

Pre rastavljanja lampe isključite lampu iz struje.

1: odvrnite stakleni poklopac u smeru suprotnom od kazaljke na satu.

2: uklonite aluminijumsku cev nagore.

3: Uklonite zavrtnje poklopca

4: izvadite baterije

Ovaj proizvod sadrži više izvora svetlosti klase energetske efikasnosti: G

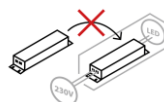

Upravljački uređaj se ne može menjati.

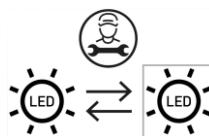

Zamena LED izvora svetla od strane stručnog lica.

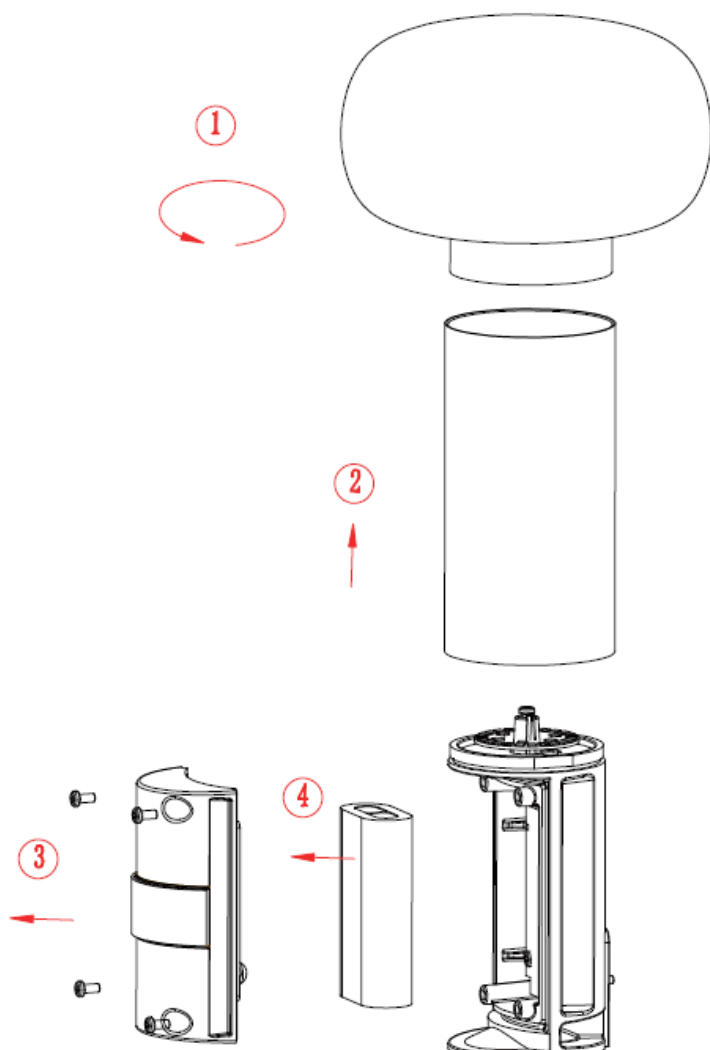

Dieter Knoll Collection

92300005/01
92300005/02
92300005/03

92300005/04
92300005/05



PREKIDAČ OSETLJIV NA DODIR (UKLJ./ISKLJ.)
Funkcija memorisanja za jačinu svetlosti. Svaki put kada uključite lampu, ona se uključuje na poslednjoj postavci jačine svetlosti.

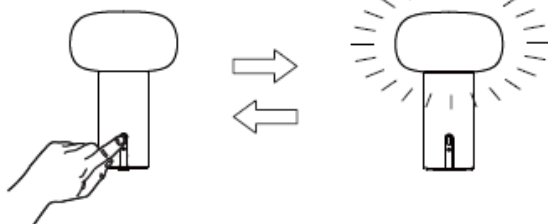
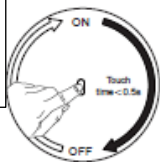

BESTEPENO DIMOVANJE
Ova funkcija je moguća samo kada je lampa uključena.

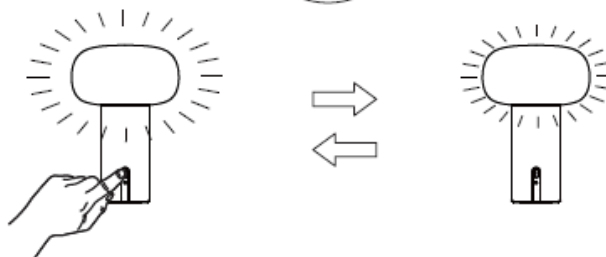
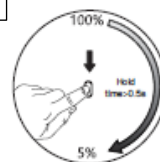

PREKIDAČ ZA TEMPERATURU BOJE
Ova funkcija je moguća samo kada je lampa isključena.

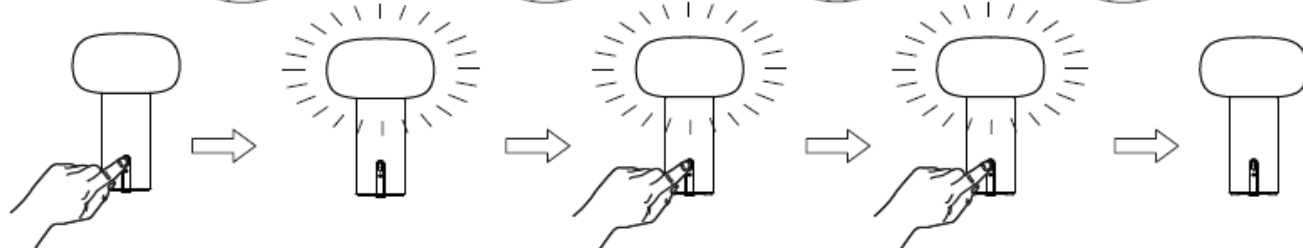
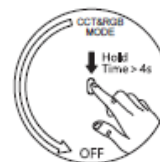
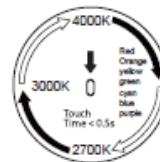
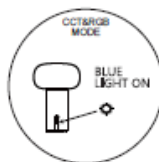
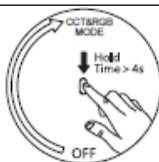

Dieter Knoll Collection

92300005/01 92300005/04
92300005/02 92300005/05
92300005/03



Lampa automatski isključuje režim prebacivanja temperature boje, ako se u roku od 10 sekundi ništa ne pritisne.

PUNJENJE UREĐAJA

ORANGE GREEN

Auto Off Time=10s

USB Adapter DC5V 1A (Optional)

TABLE LAMP IP65

CONNECTING CHARGING BASE E20

HOT Avoid direct sunlight

Dieter Knoll Collection

92300005/01 92300005/04
92300005/02 92300005/05
92300005/03



FR:

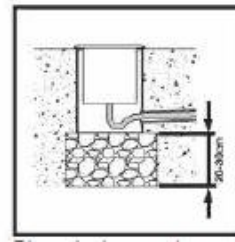
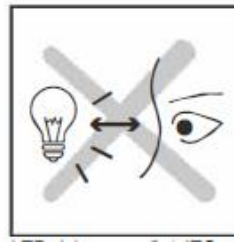
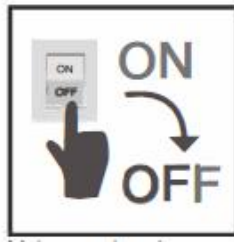

<p>Le raccordement et l'entretien du luminaire ne peuvent être effectués que par le personnel formé et qualifié, dans le respect des prescriptions en vigueur.</p>	<p>Assurez-vous que le luminaire est débranché de l'alimentation électrique avant d'effectuer des travaux d'entretien.</p>	<p>Groupe à risque LED 0-1, norme : IEC 62471 Ne regardez pas directement dans la lumière lorsqu'elle est allumée. Risque de lésions oculaires.</p>	<p>Placez l'encasté de sol sur une couche de drainage (gravier) de 20 à 30 cm d'épaisseur et remplissez d'eau. Si l'eau ne s'est pas complètement écoulee au bout de 30 minutes, vous devez installer un système de drainage supplémentaire (par exemple un tuyau d'évacuation).</p>	<p>Pour éviter l'accumulation d'eau, n'installez pas l'encasté de sol dans un creux.</p>
--	--	---	--	--

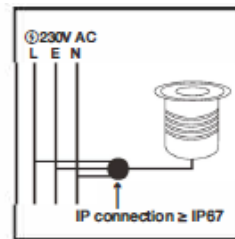
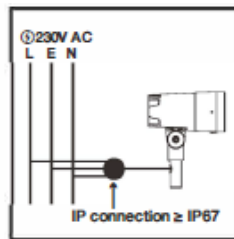
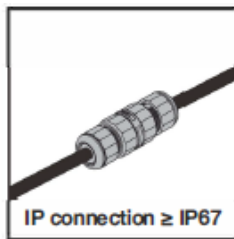
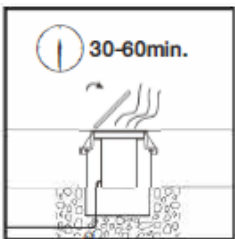

<p>Si vous démontez des encastrés de sol, des projecteurs ou des bornes, allumez les luminaires pendant 30 à 60 minutes avant de les démonter afin que l'humidité éventuellement présente s'évapore.</p>	<p>Le raccordement électrique des luminaires dont le câble de raccordement est câblé en usine doit correspondre au moins au type de protection IP67.</p>	<p>Le raccordement électrique des projecteurs doit correspondre au moins au type de protection IP67.</p>	<p>Le raccordement électrique des encastrés de sol doit correspondre au moins au type de protection IP67.</p>	<p>Tous les luminaires sont équipés d'un système d'étanchéité qui offre une protection efficace contre l'infiltration d'eau et d'humidité le long des câbles de raccordement.</p>
--	--	--	---	---

Dieter Knoll Collection

92300005/01 92300005/04
92300005/02 92300005/05
92300005/03

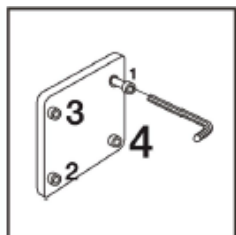

Si le câble flexible extérieur du luminaire est endommagé, il doit être remplacé uniquement par le fabricant ou par un professionnel qualifié afin d'éviter tout danger.

Serrez les vis en alternance ou en croix. Procédez de la même manière pour desserrer les vis.

Pour faciliter l'entretien (dévissage) du luminaire, il est recommandé de protéger le filetage des vis avec de la graisse silicone avant d'exposer le luminaire aux intempéries.

Maintenez le luminaire propre afin d'éviter que de la saleté ne se dépose sur le cadre et les vis. Pour les pièces en acier inoxydable, n'utilisez que des produits de nettoyage spécialement conçus à cet effet.

N'exposez pas le luminaire à des produits agressifs ou à des substances chimiques (par ex. des engrais, des désherbants, de la chaux).

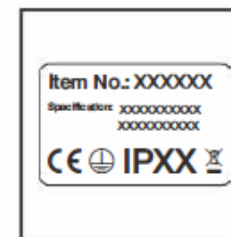
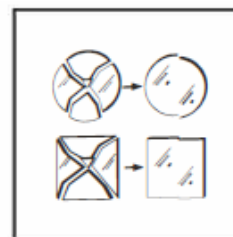
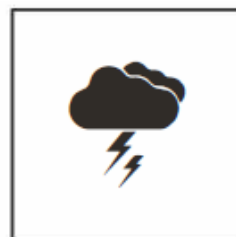

N'utilisez pas de nettoyeur haute pression.

Il s'agit d'un appareil électronique qui est sensible aux surtensions. L'installation d'une protection contre les surtensions atténue l'intensité des surtensions et protège les appareils contre les dommages.

Si le diffuseur est endommagé, remplacez-le avant d'allumer le luminaire.

Conservez ce mode d'emploi.

Les caractéristiques techniques sont indiquées sur la plaque signalétique du produit.

Démontage du module LED

Débranchez la lampe avant de la désassembler.

1 : dévissez le couvercle en verre dans le sens inverse des aiguilles d'une montre.

2 : retirer le tube aluminium vers le haut.

3 : Retirez les vis du couvercle.

4 : retirer les piles

Ce produit contient plusieurs sources lumineuses de classe d'efficacité énergétique : G

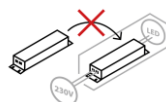

Appareillage de commande non remplaçable.

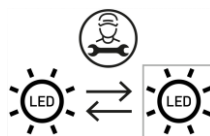

Remplacement de l'ampoule LED par un professionnel.

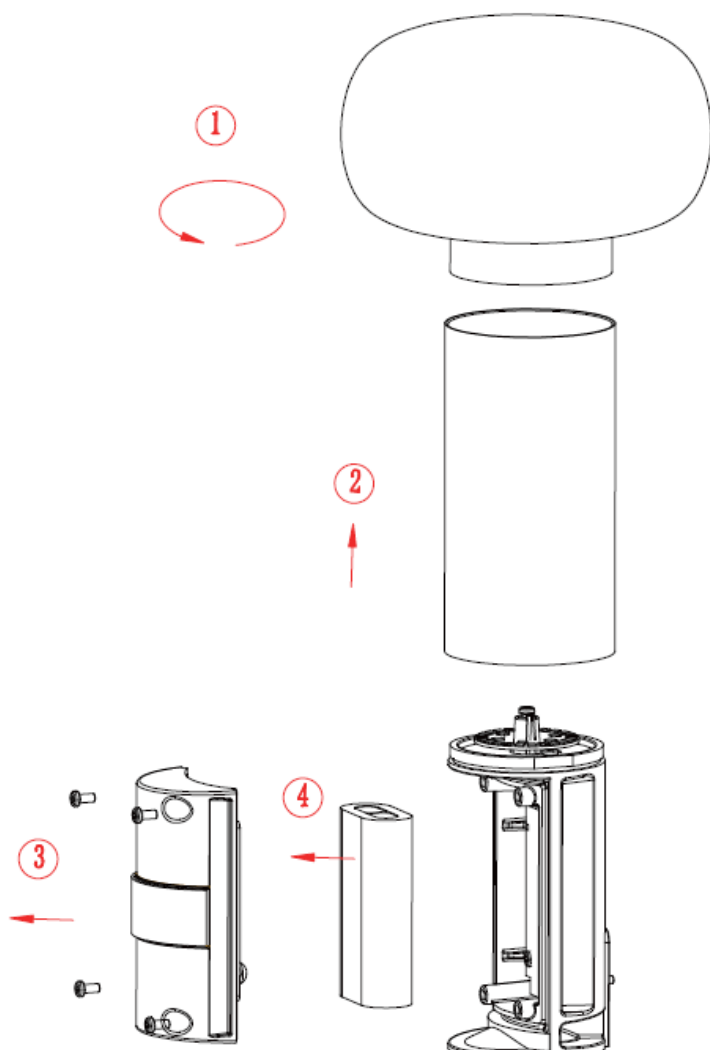

Dieter Knoll Collection

92300005/01
92300005/02
92300005/03

92300005/04
92300005/05



<p>INTERRUPTEUR TACTILE (MARCHÉ/ARRÊT) Fonction mémoire pour la luminosité. Chaque fois que vous allumez la lampe, elle reprend la dernière luminosité réglée.</p>	<p>VARIATION EN CONTINU Cette fonction n'est disponible que si la lampe est allumée.</p>
<p>CHANGEUR DE TEMPERATURE DE COULEUR Cette fonction n'est disponible que si la lampe est éteinte.</p>	

Dieter Knoll Collection

92300005/01 92300005/04
92300005/02 92300005/05
92300005/03



La lampe désactive automatiquement le mode de changement de température de couleur s'il n'y a aucune commande pendant 10 secondes.

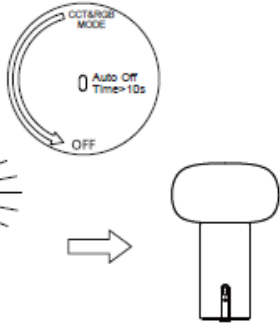

CHARGE DE L'APPAREIL

