

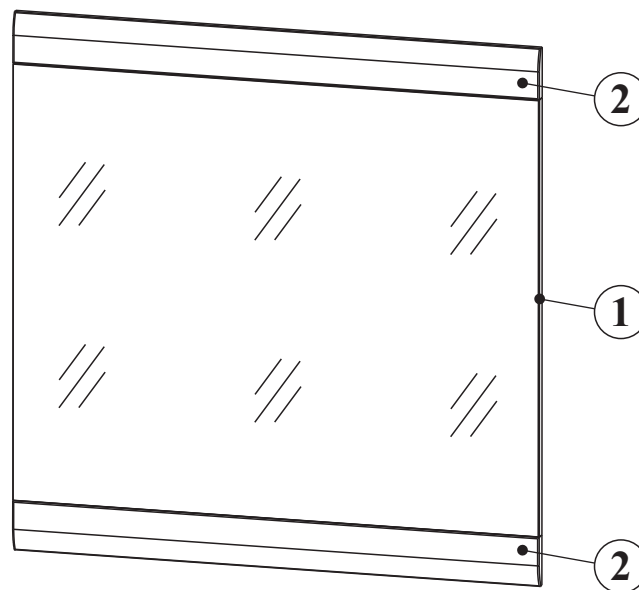





B - 842mm
 H - 856mm
 T - 18mm

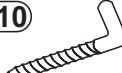

NR 1

B20		x4
φ 8x50		
M1		x6
φ15x12mm		
T1		x6
5x39mm		
C18		x2
5mm		
T10		x3
T13		x3
8x50 mm		

1	696	842	1	1/1
2	842	80	2	1/1



1

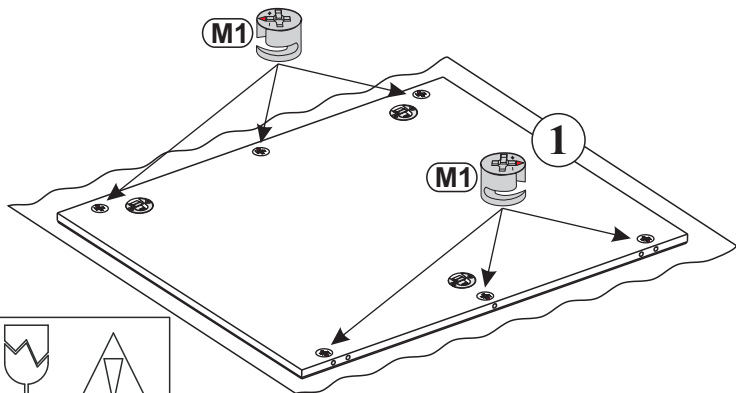
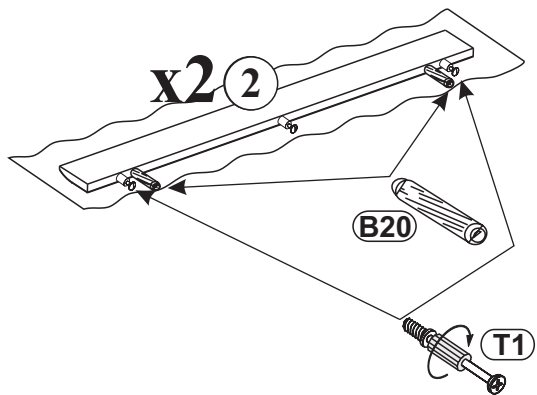
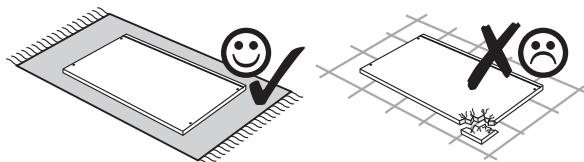
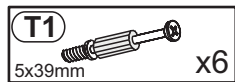
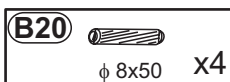
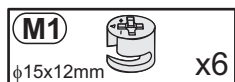
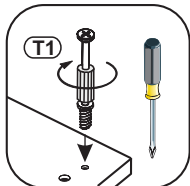
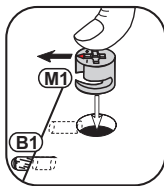

2

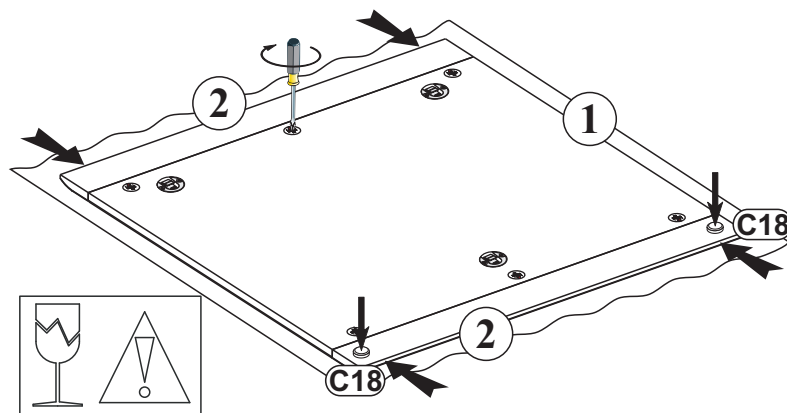
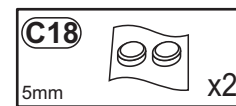

3

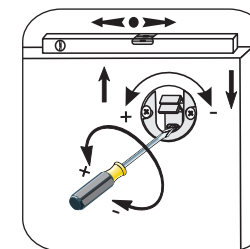
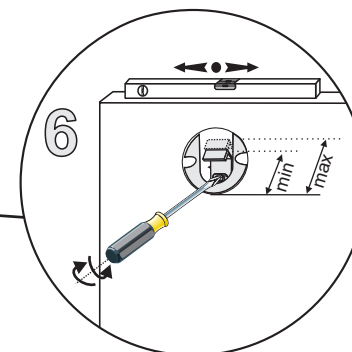
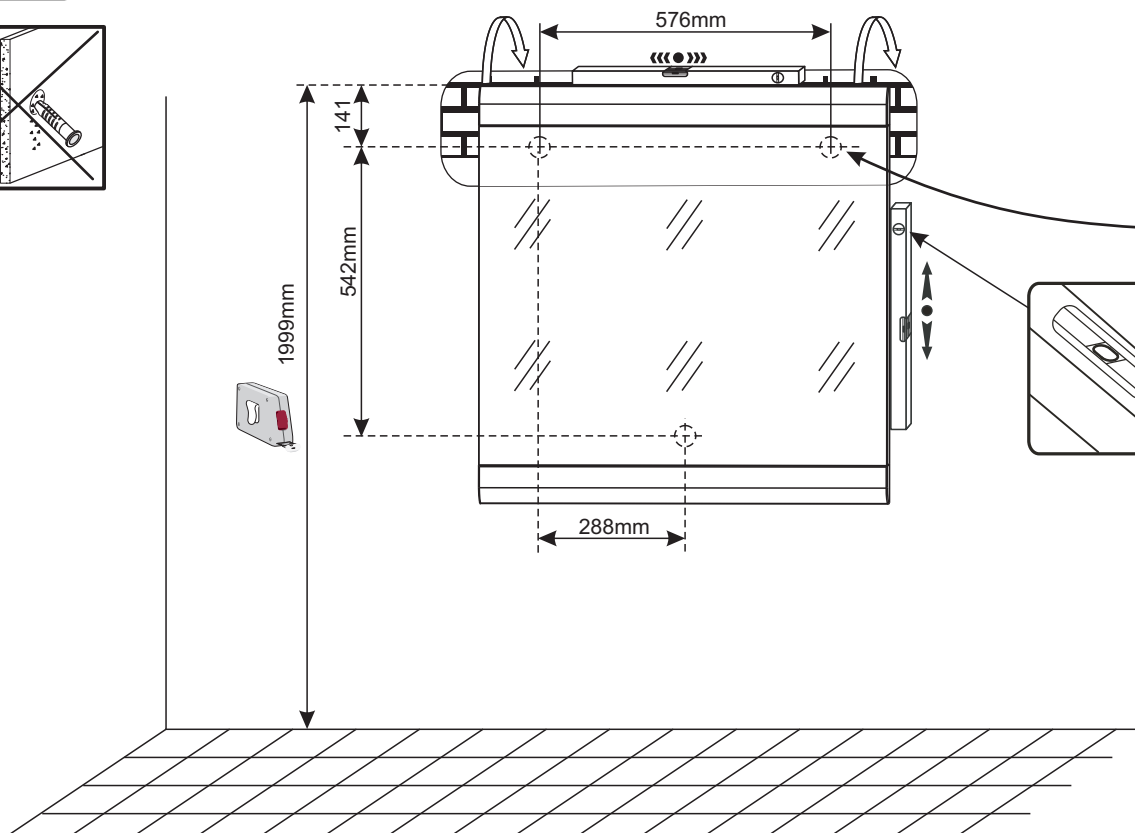
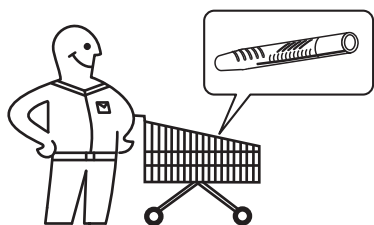
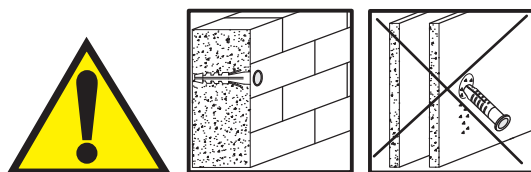
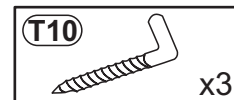
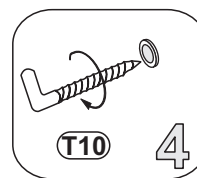
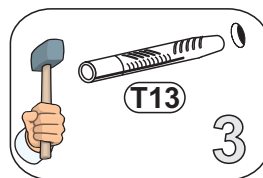
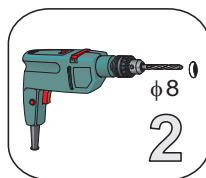
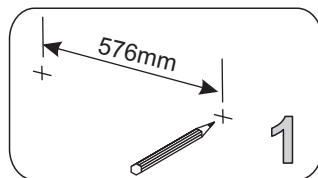
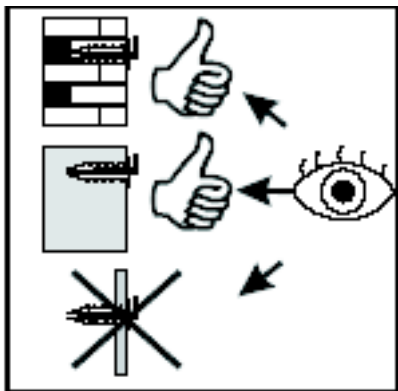

80

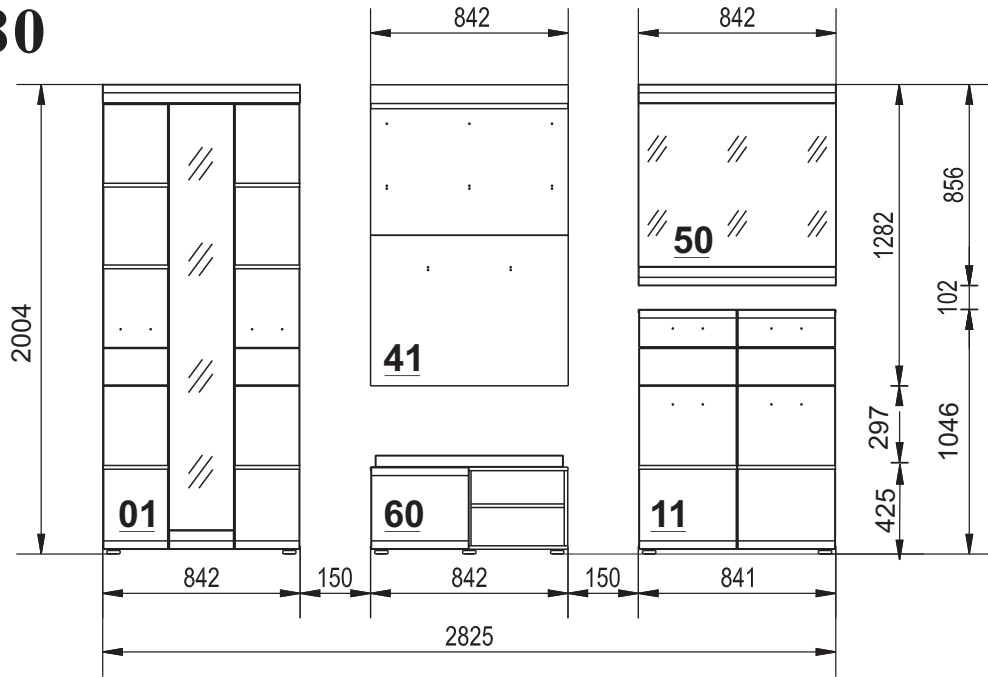

D CH AT LI LU Kleintelle und Verpackungsfolien bei der Möbelmontage von Kindern fernhalten!
GB US Keep small parts and plastic film out of the reach of children!
FR BE NC Tenir les petites pièces et les films plastiques hors de la portée des enfants!
NL Hou de kleine onderdelen en de plastic folie uit de buurt van kinderen!
IT Tenere i componenti di piccole dimensioni e le pellicole di plastica fuori dalla portata dei bambini!
SI Malhni delov i foliju za pakovanje priklom montaži pohištna priane izven dosega otrok!
XS HR BA Mañe dijelove i foliju za pakovanje priklom montaže namještaja držite dalje od djece
HU Bútorészeket közbén a kis alkatrészek és a csomagoló fóliák gyerekekkel távol tartandók!
BG Дребни детайли и опаковъчни фолия да се държат далеч от деца при монтажа на мебелите!
CZ SK Vid montáži nábytku uchovávejte drobné díly a obalové fólie z dosahu dětí!
SE Vid möbelföringen ska smådelar och förpackningsfolien hållas oåtkomliga för barn!
RO Țineți departe de copil piesele mici și folia de ambalat la montarea mobiliei!
ES ¡Durante el montaje, mantenga alejados de los niños las piezas pequeñas y el material plástico de embalaje!

D CH AT LI LU Möbelmontage muss auf ebennem Untergrund erfolgen. Bei Wandmontagen immer geeignetes Befestigungsmaterial verwenden.
GB US Furniture must be assembled on a flat surface. For assembly to the wall only use suitable fixing materials.
FR BE NC Le meuble doit être monté sur une surface plane. Pour le montage mural, utilisez des accessoires de fixation adaptés au type de mur.
NL De meubels dienen op een vlakke ondergrond te worden gemonteerd. Voor wandmontage moeten geschikte bevestigingsmaterialen worden gebruikt.
IT Il montaggio dei mobili deve avvenire su un fondo piano. Per il montaggio si prega di utilizzare solo materiali adatti.
SI Pohištvo je treba montirati na ravni podlagi. Pri stenski montaži vedno uporabite pritrilveni material.
XS HR BA Namještaj se mora montirati na ravnoj podlozi. Kod montaže na zid uvijek koristite prikladan materijal za pričvršćivanje.
HU A bútorcszerelési silk felületen kell végezni. Falra szereléshez mindig megfelelő rögzítianyagot kell használni.
BG Монтажът на мебелите да се извършва на равна основа. При стънен монтаж винаги да се използва подходящ крепежен материал.
CZ SK Montáž nábytku provádějte na rovném podkladu. Při montáži na stěnu používejte vždy vhodný příslušenací materiál.
SE Monteringen av möbelen måste göras på jämnt underlag. Vid väggmontering ska lämpligt uppfästingsmaterial användas.
RO Montarea mobiliei trebuie să se realizeze pe o pardoseală dreaptă. La montarea la perete utilizați întotdeauna material de fixare adecvat.
ES El montaje debe efectuarse sobre una superficie uniforme. En el montaje mural emplee siempre el material de fijación adecuado.

D CH AT LI LU Bitte beachten Sie die Montageanleitung. Halten Sie immer die angegebene Wattzahl ein. Verhindern Sie einen Hitzestau.
GB US Please observe the assembly instructions. Do not exceed the max. given wattage. Ensure that the heat is not allowed to build up.
FR BE NC Veuillez respecter la notice de montage. Respectez impérativement le nombre des watts maximal. Veillez à éviter toute accumulation de chaleur.
NL Lees a.u.b. de montagehandleiding door. Hou de beslist aan het max. opgegeven wattage. Zorg ervoor dat geen hittehuwning onstaat.
IT Attenersi alle istruzioni di montaggio. Rispettarsi rigorosamente il numero di watt max. indicato. Assicurarsi che non si verifichi un accumolo di calore.
SI Upoštevajte navodila za montažo. Vedno upoštevajte navedeno število vatov. Preprečite zastoj vročine.
XS HR BA Obratite pažnju! Vas pozor na uputu za montažu. Uvijek se pridržavajte navedenog broja vat. Izbjegavajte zastoj vrućine.
HU Vegye figyelembe a szerelési útmutatót. Mindig tartsa be a megadott wattszámot. Akadályozza meg a hőelődést.
BG Моля, вземете под внимание ръководството за монтаж. Спазвайте винаги посочените ватове. Избягвайте акумулиране на топлина.
CZ SK Dodržujte prosím návod k montáži. Vždy dodržujte uvedenou hodnotu výkonu (watt). Zabráňte tak přehřívání.
SE Följ monteringsanvisningen. Följ alltid angivet watttal. Undvik att hetta uppstår.
RO Respectați instrucțiunile de montaj. Respectați întotdeauna numărul de watt impus. Evitați acumularea de căldură.
ES Le rogamos que tenga presente las instrucciones de montaje. Respete siempre el número indicado de vatios. Evite la acumulación de calor.

D CH AT LI LU Halten Sie die max. zulässigen Belastungswerte der Möbelteile ein. Details siehe Montageanleitung
GB US Comply with the max. permissible loads. For details, please refer to the assembly instructions
FR BE NC Respectez les valeurs de charge max. admissibles des parties de meubles. Pour plus de détails, cf. la notice de
NL Hou de maximaal geoorloofde belastingwaarden van de meubeldelen aan. Voor details verwijzen wij naar de montagehandleiding
IT Rispettare la portata max. permessa degli elementi del mobile. Per dettagli si vedano le istruzioni di montaggio e si vada
SI Upoštevajte največjo dovoljeno obremenitev delov pohištva. Podrobnosti najdete v navodilih za montažo in na
XS HR BA Tartsa be a bútorelemek max. megengedett terhelési értékét. A részleteket lásd a szerelési útmutatóban
HU Tartsa végre a bútorelemek max. megengedett terhelési értékét. A részleteket lásd a szerelési útmutatóban
BG Спазвайте макс. допустимите стойности на натоварване на мебелите. За подробности виж ръководството за монтаж
CZ SK Dodržujte max. přípustné hodnoty zatížení nábykových dílů. Podrobnosti viz návod k montáži
SE Följ max. tillåten belastning av möbeldelarna. Mer information finns i monteringsanvisningen
RO Respectați valorile de solicitare max. admise pentru corpurile de mobilier. Pentru detalii consultați instrucțiunile de montaj
ES Respete los valores máximos de carga admisibles para las piezas de los muebles. Consulte los detalles en las instrucciones

D CH AT LI LU Zur Möbelfeinigung ein mit Wasser befeuchtetes, fusselfreies Baumwolltuch verwenden. Geeignigte Flächen immer trockenreiben!
GB US To clean the furniture only use a water dampened lint-free cotton cloth. Once cleaned, always wipe the surfaces dry.
FR BE NC Utilisez un chiffon en coton non pelucheux humidifié avec de l'eau pour nettoyer les meubles. Séchez systématiquement les surfaces
NL nettoyées en les frottant!
IT Gebrauk een met water bevochtigde, pluusvrije katoenen doek om de meubels te reinigen. Wrijf gereinigde oppervlakken altijd droog!
SI Per pulire il mobile utilizzare un panno di cotone inumidito d'acqua e che non perde pelucchi. Asciugare sempre le superfici che si sono
XS HR BA kromi!
HU Za čišćenje pohištva uporabljajte vlažno bombažno krpo, ki ne pušča vlaken. Očiščene površine vedno obrišite do suhnega!
BG За чišćenje namještaja koristite sa vodom navlaženu pamučnu krpu koja ne ispušta vlakna. Očiščene površine uvijek obrišite suhom
CZ SK K čišťení nábytku používejte bavlněný hadr neuvloňující vlákna, navlhčený ve vodě. Učistěné plochy vždy utřete do sucha!
SE För möbelföring används en luddfri bomullsduk fuktad med vatten. Rengörda ytor ska alltid torikas torra!
RO Pentru curățarea mobiliei utilizați o lavetă din bumbac fără scame umezită cu apă. Suprafețele curățate se șterg întotdeauna până se usucă!
ES Emplee un paño de algodón humedecido con agua y libre de pelusa para la limpieza de los muebles. ¡Seque siempre las superficies que ha limpiado!