

1398149

11250277/01

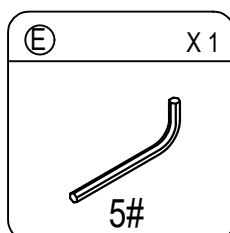

1

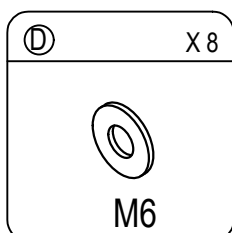
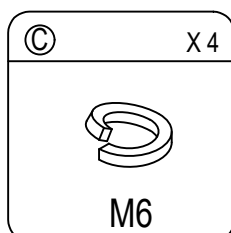
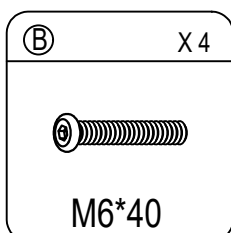
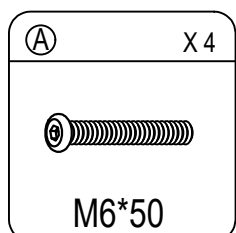
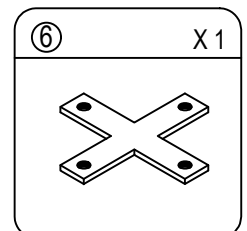
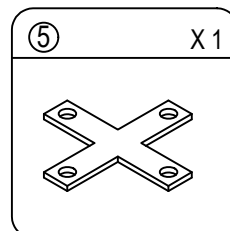
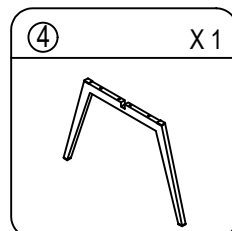
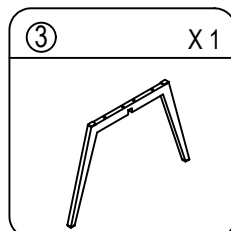
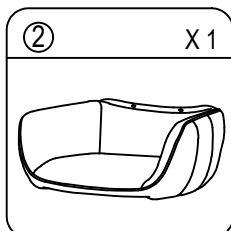
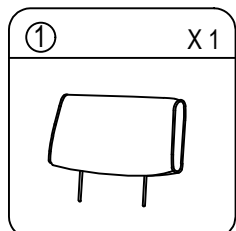
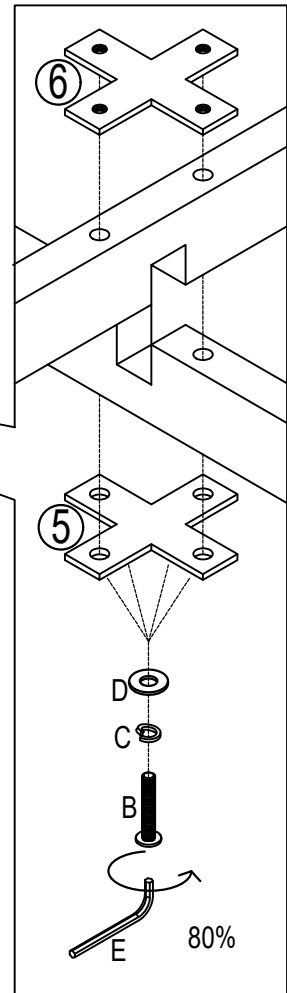
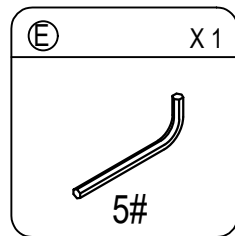
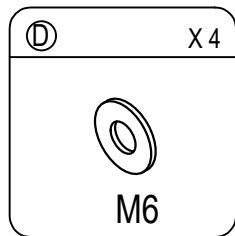
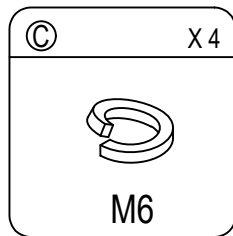
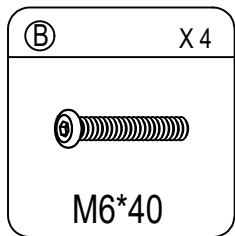
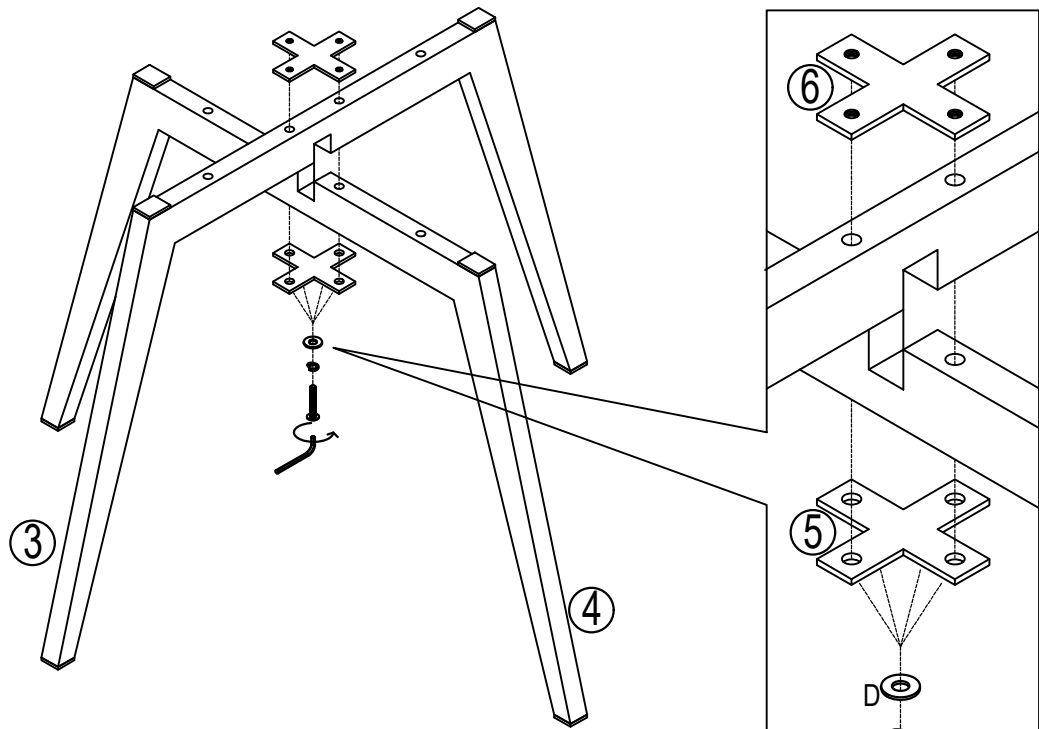

2

