

A**S643-REGN/110/40****CONNECT**

24270215/11
24270215/12

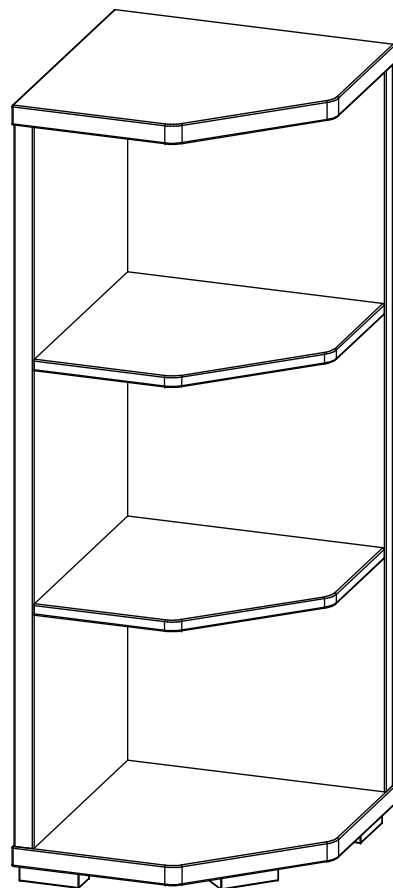

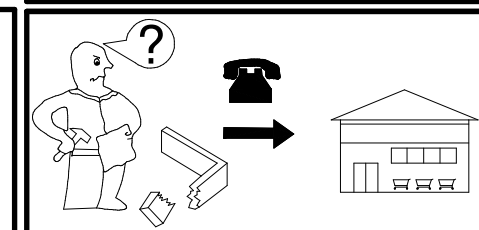
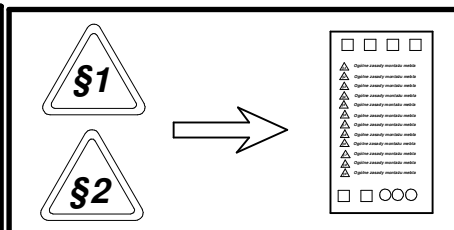
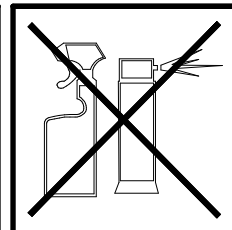
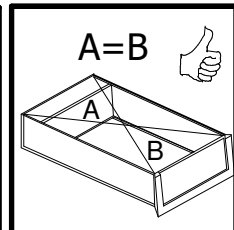
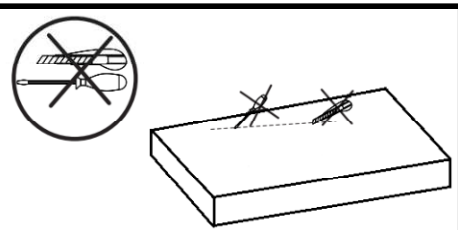
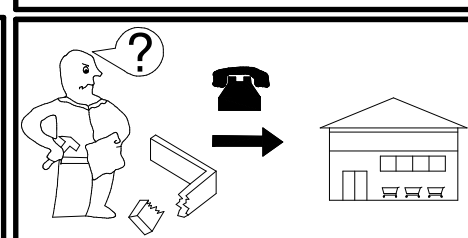
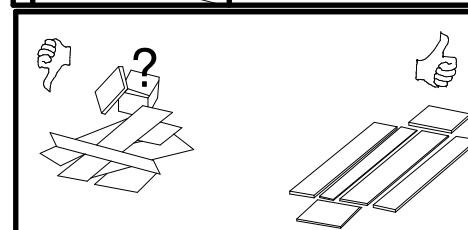
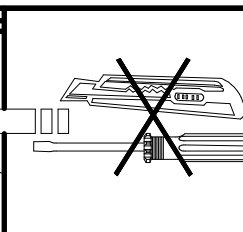
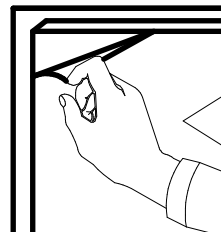
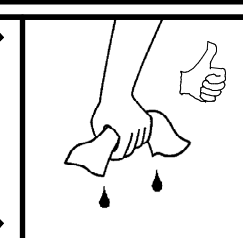
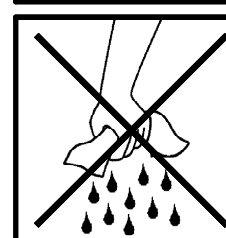
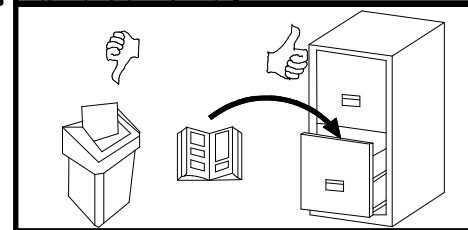
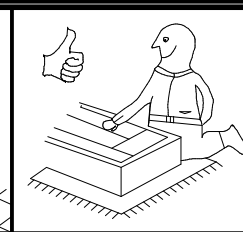
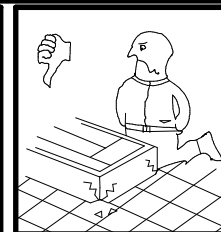
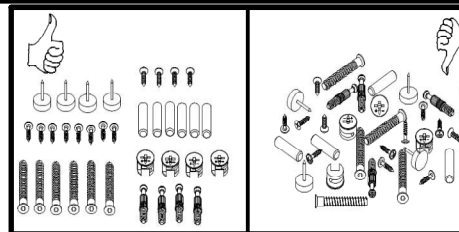
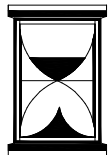
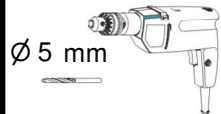
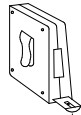
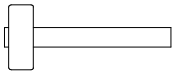
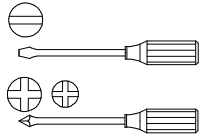
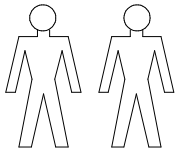

35 min

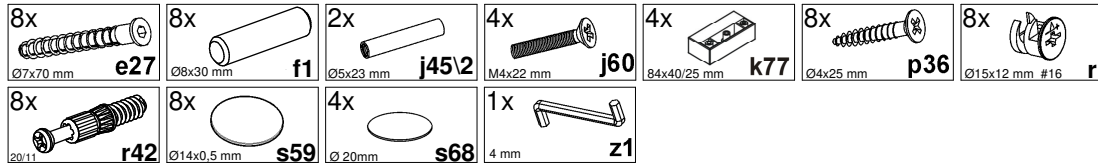

A	B1	B2	C1	C2	C3	D
1	S643-1007	-	1016	393	28	1/1
2	S643-1008	-	1016	363	28	1/1
3	S643-2007	-	395	395	28	1/1
4	S643-2008	-	395	395	28	1/1
5	S643-3003	-	361	363	16	1/1

A

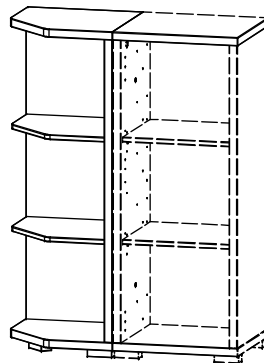

B

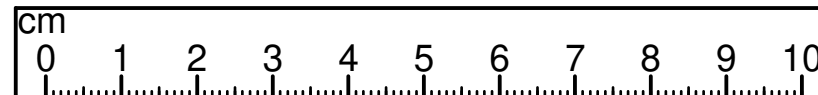
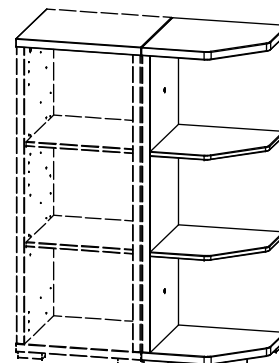

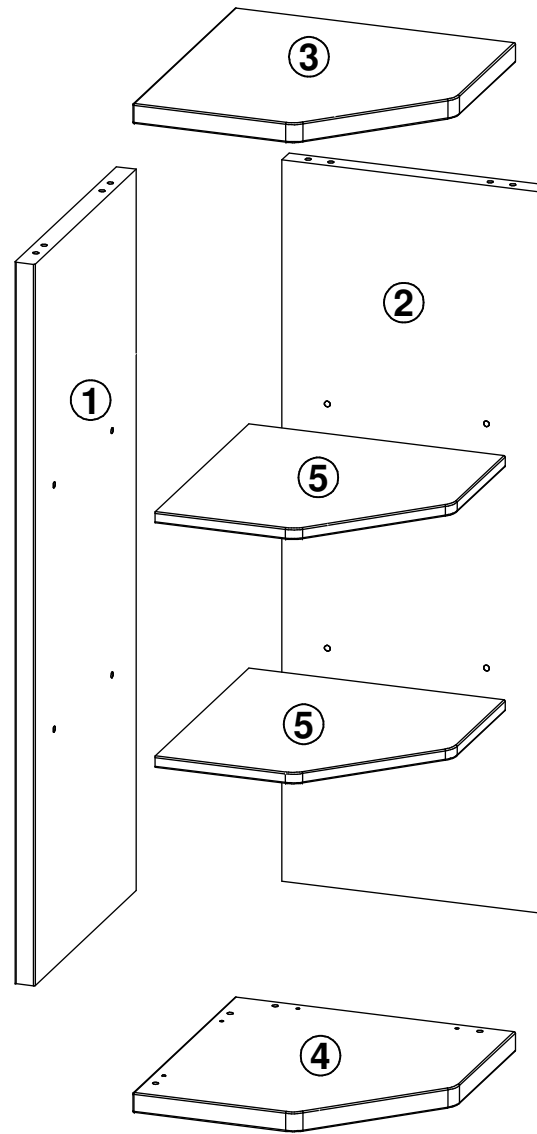

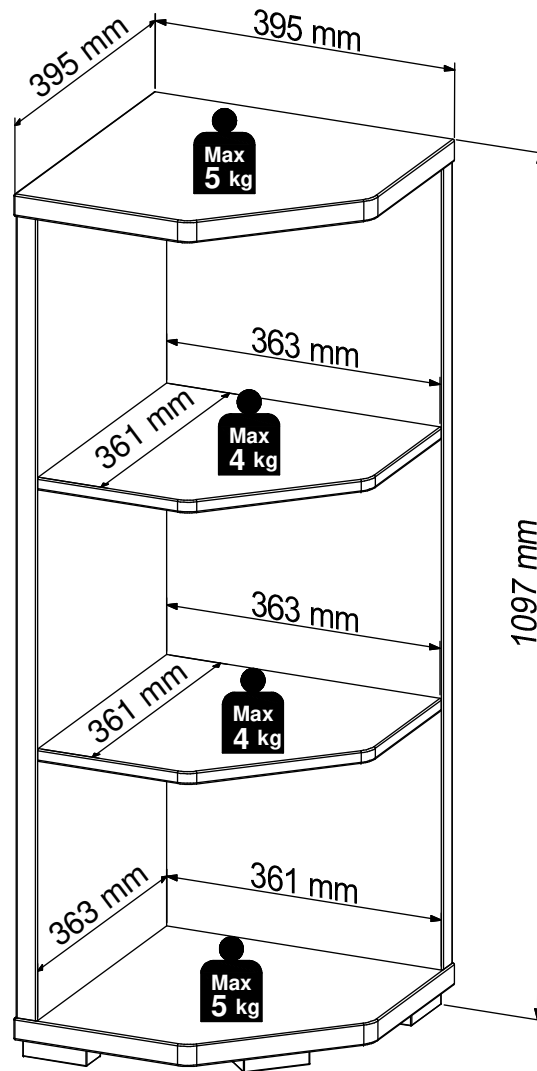

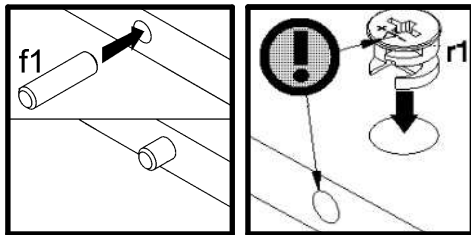
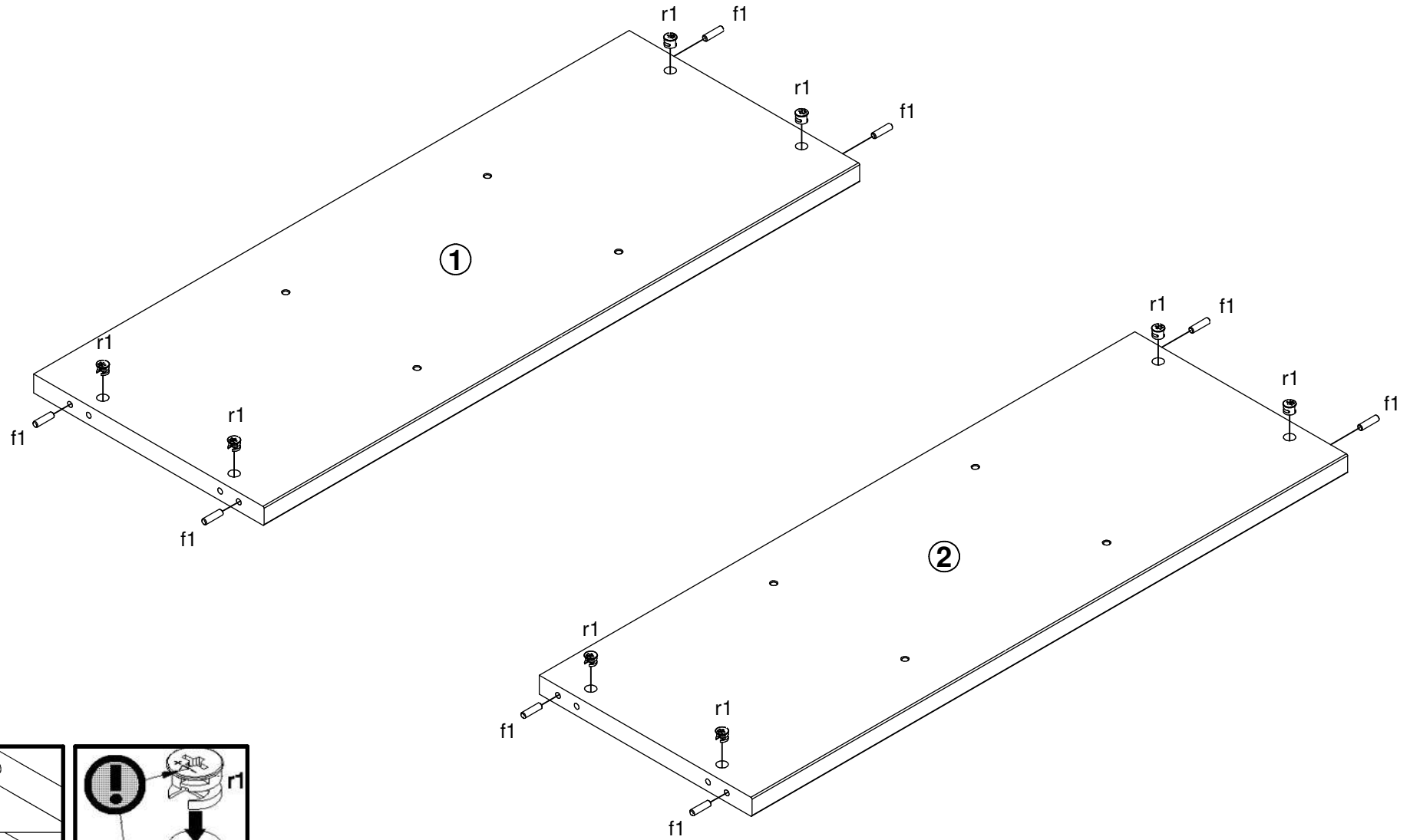
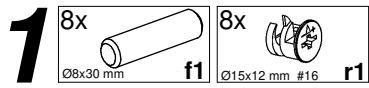

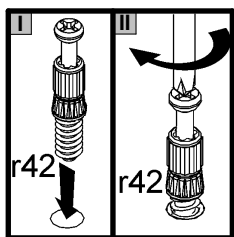
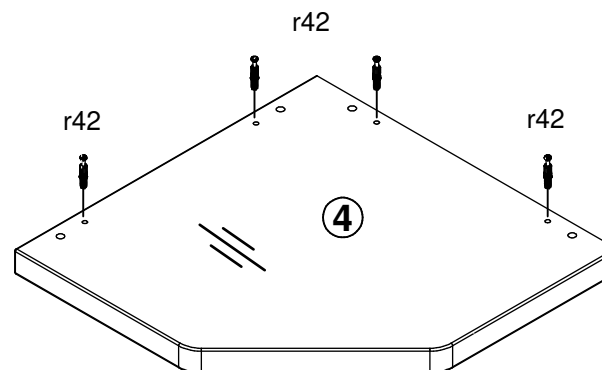
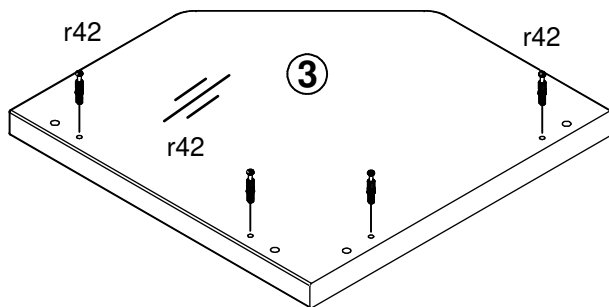
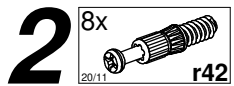

3

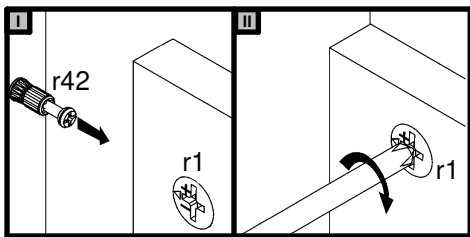
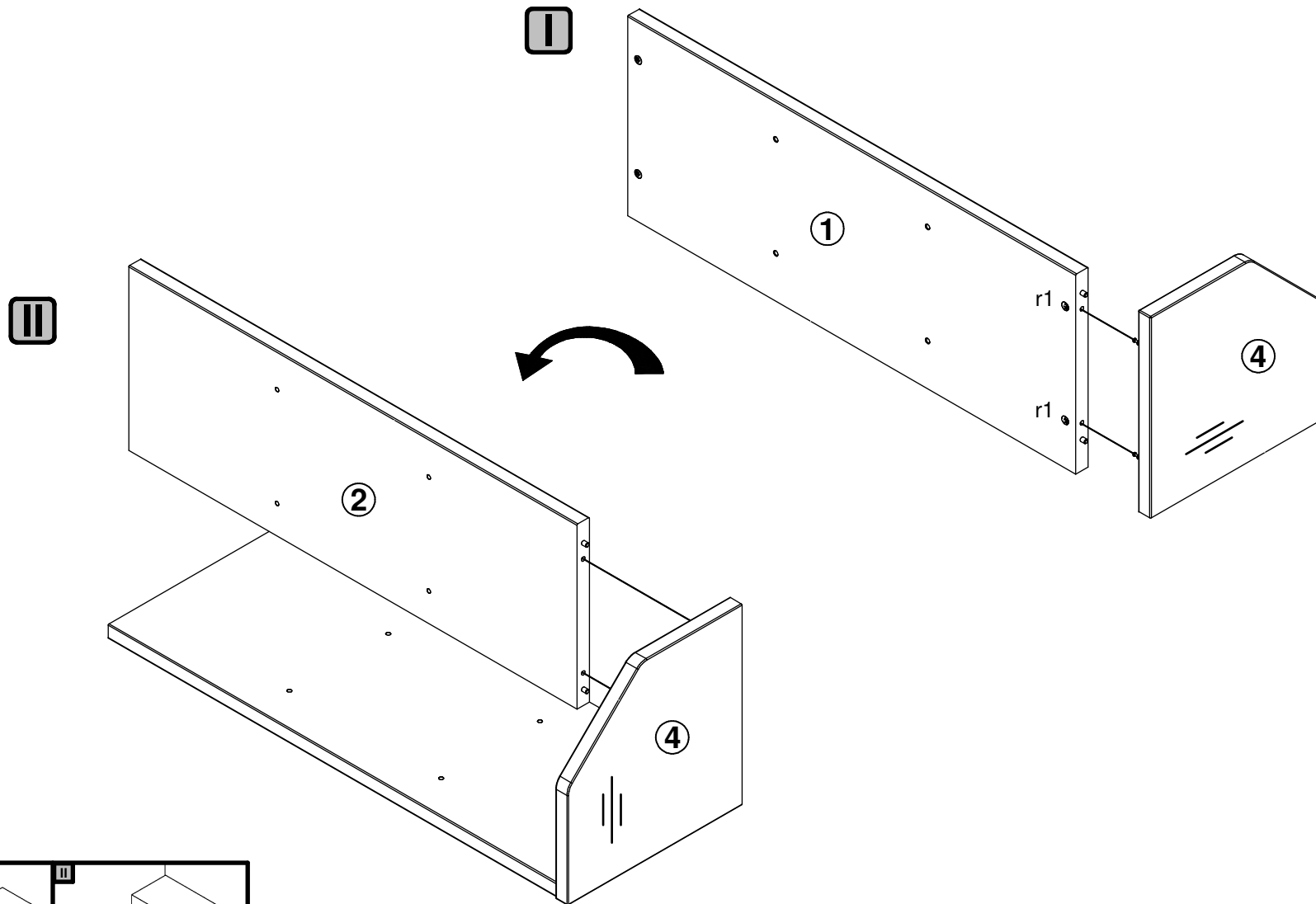

4

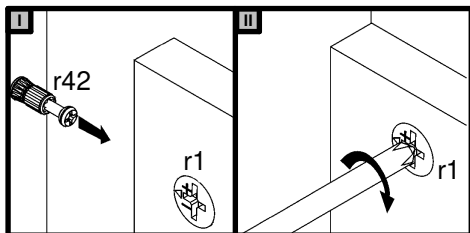
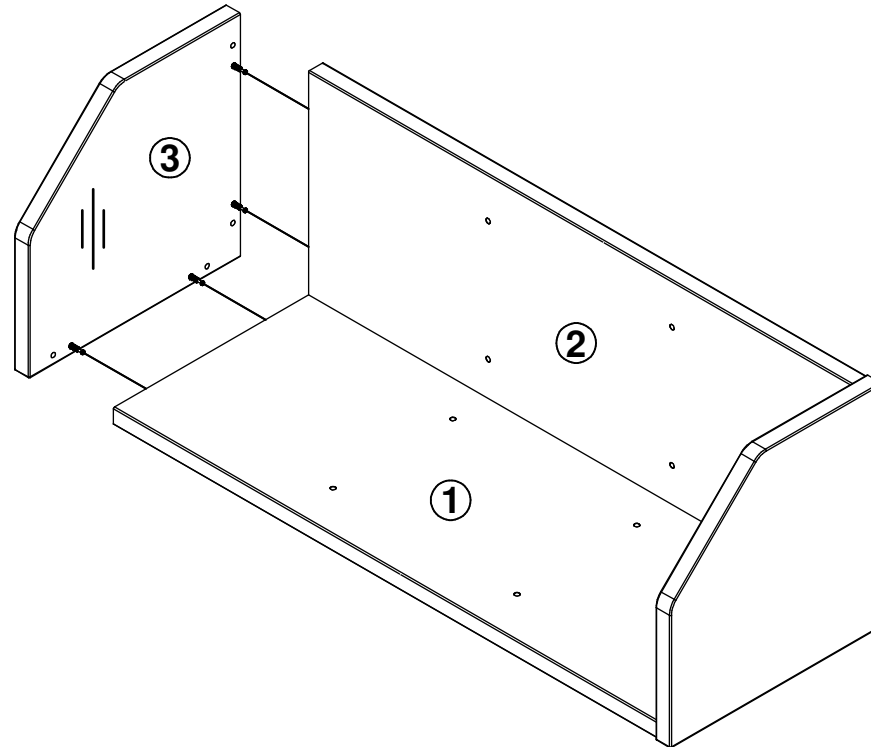

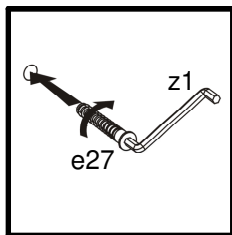
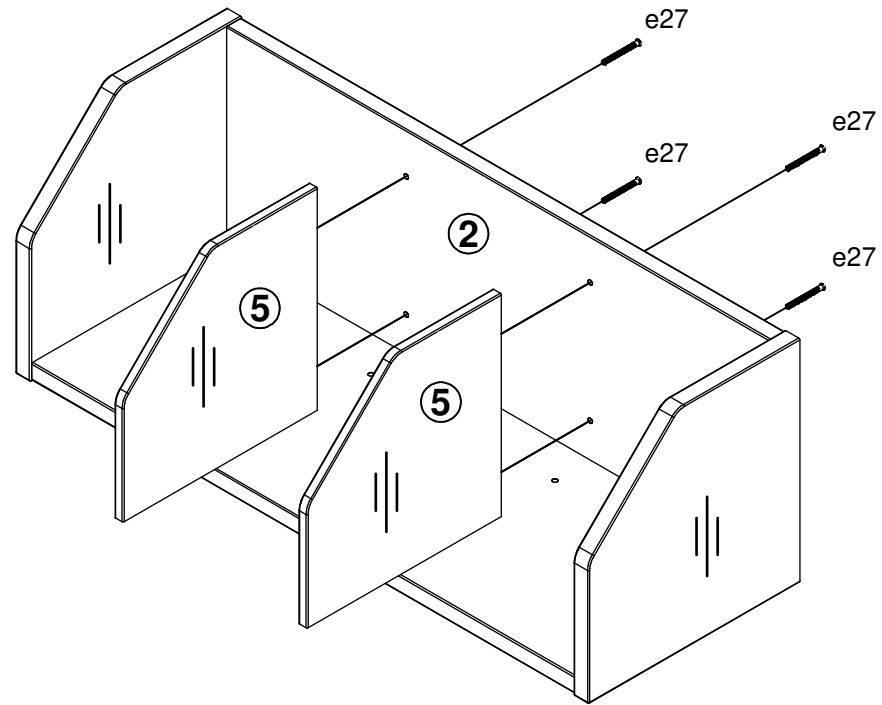
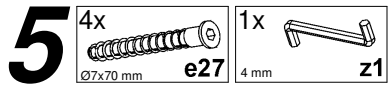

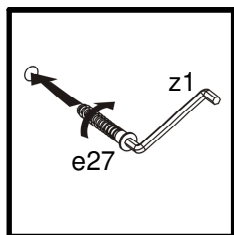
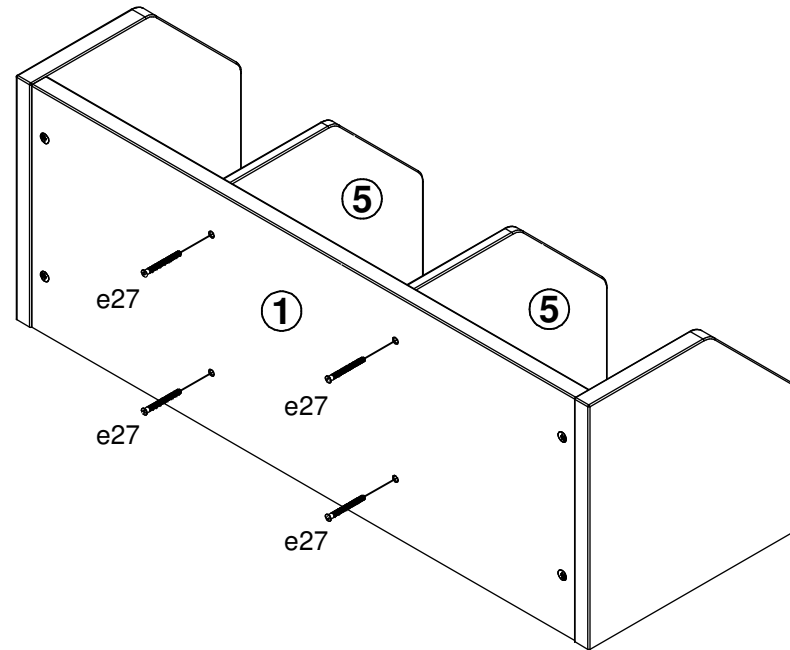
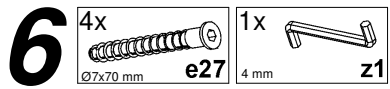

7A

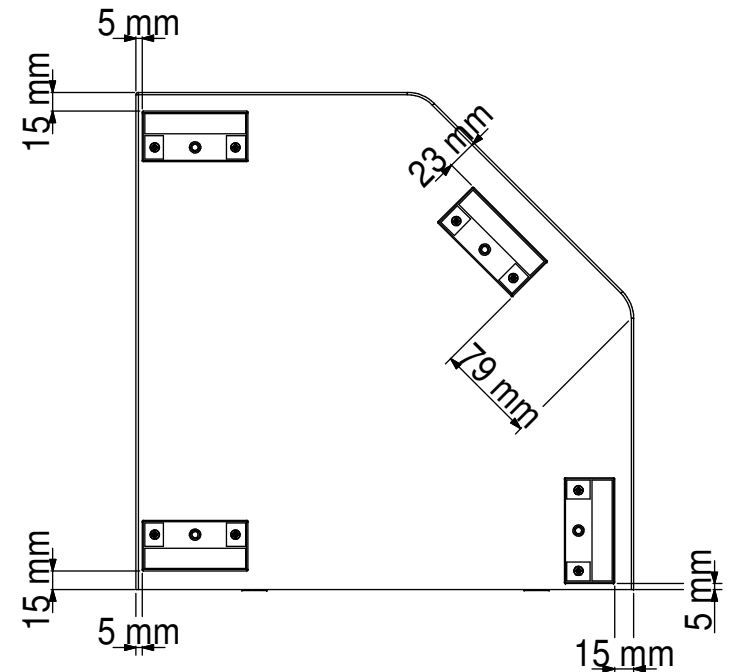
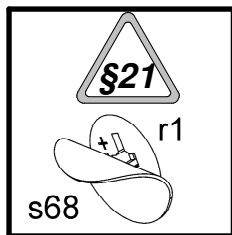
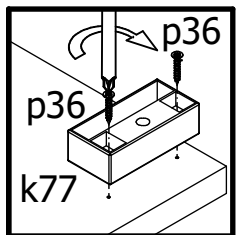
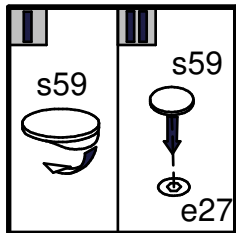
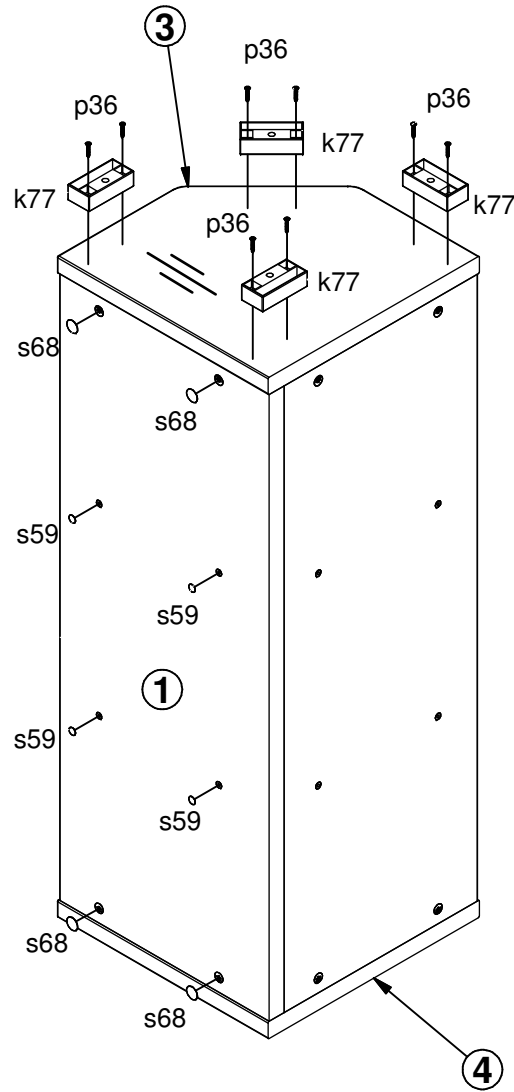
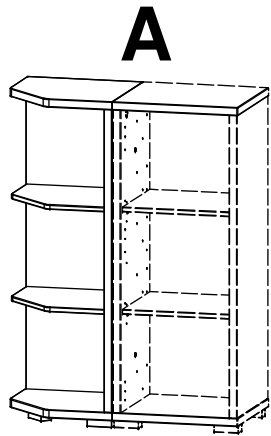
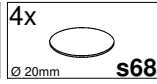
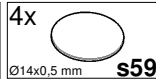
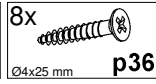
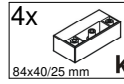

8A

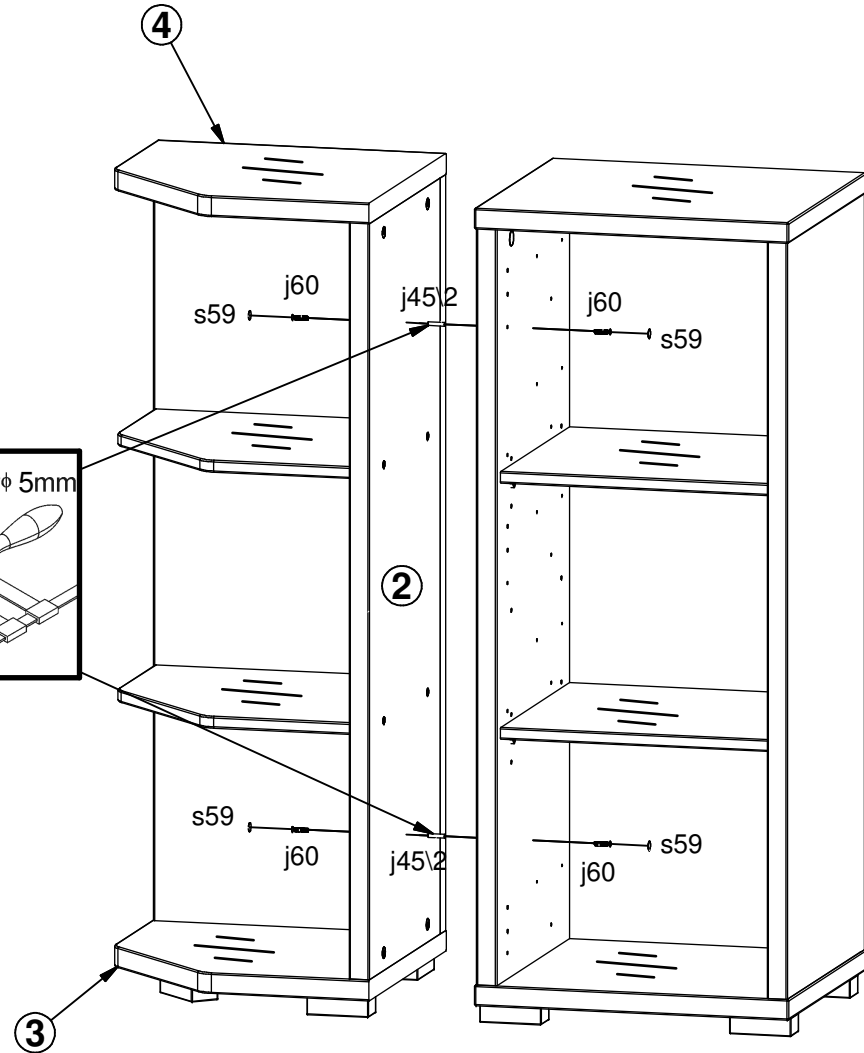
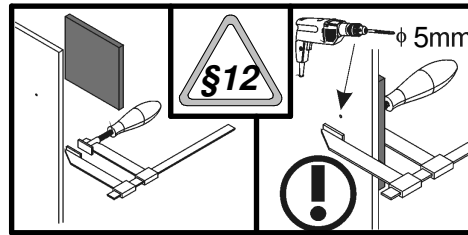
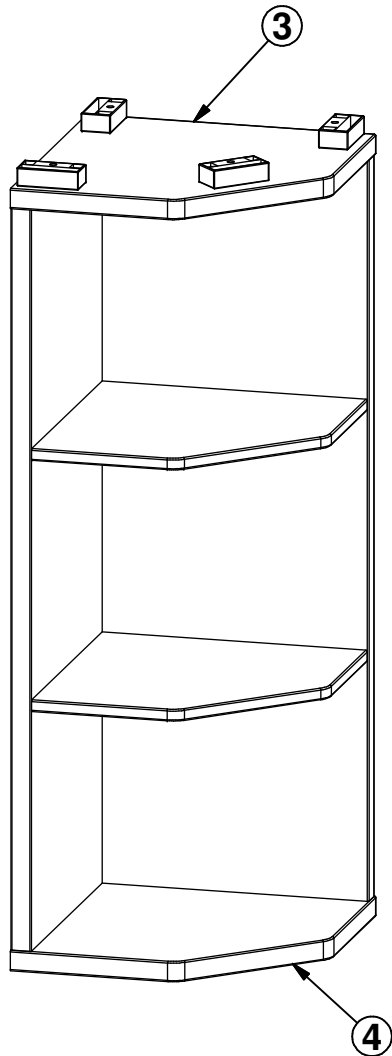
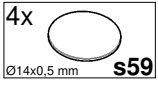
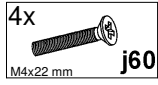
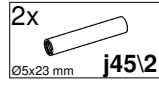

7B

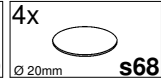
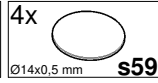
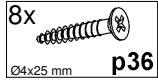
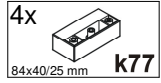

B

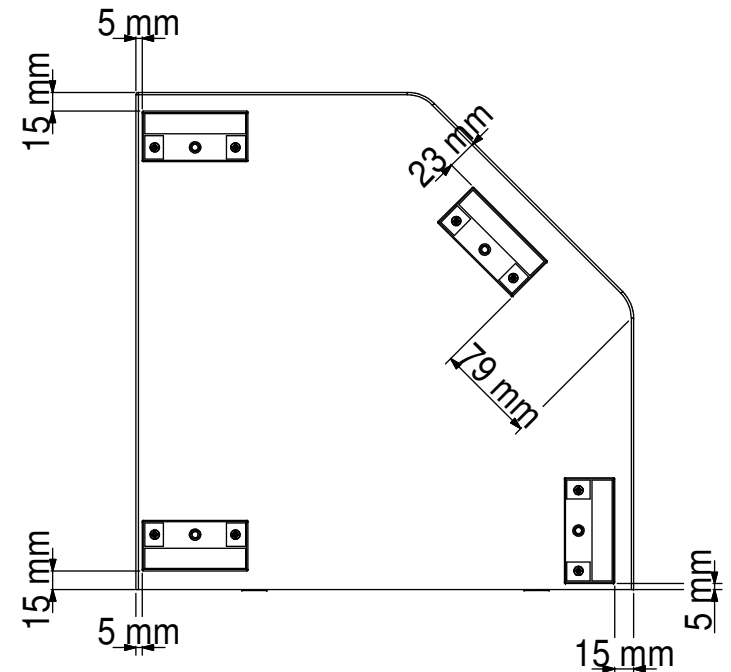
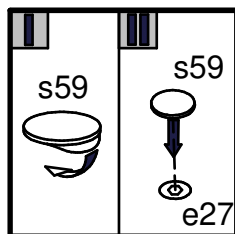
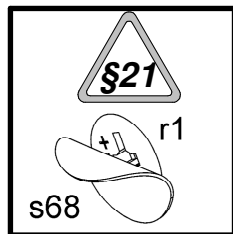
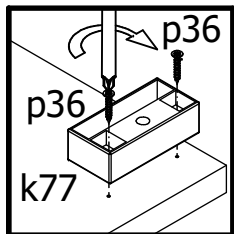
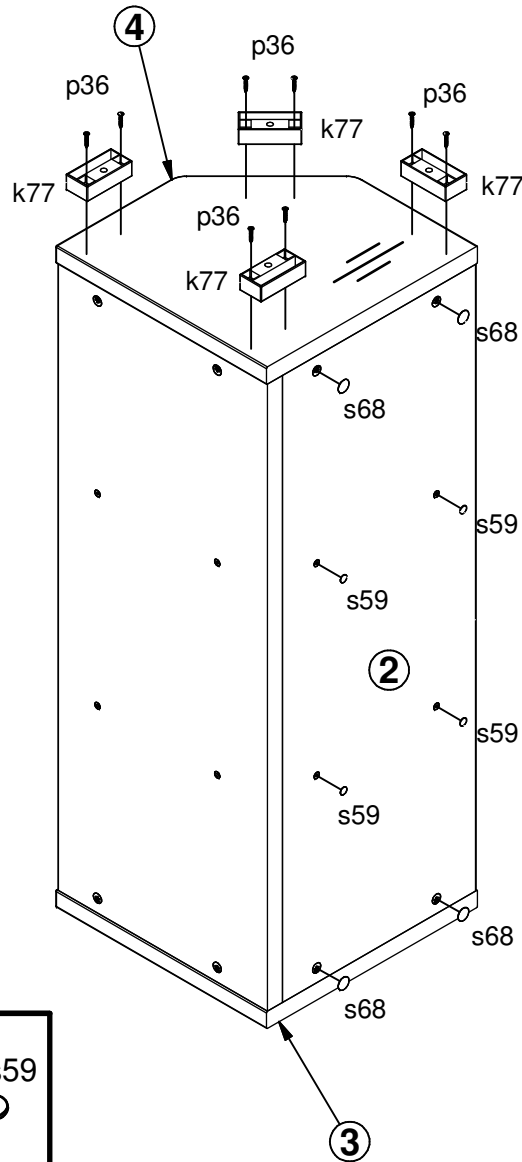
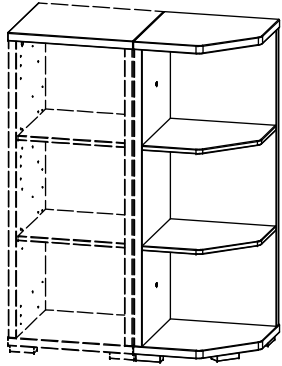

8B

2x
Ø5x23 mm j45\2

4x
M4x22 mm j60

4x
Ø14x0.5 mm s59

