

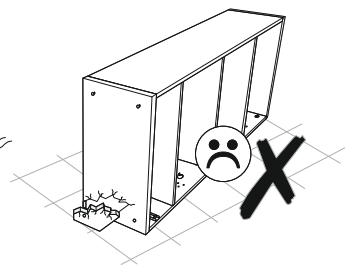

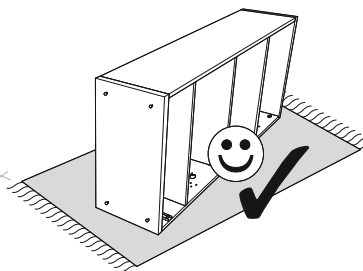

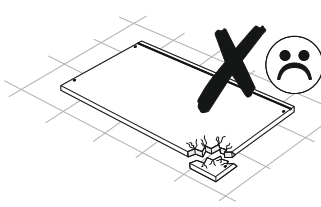

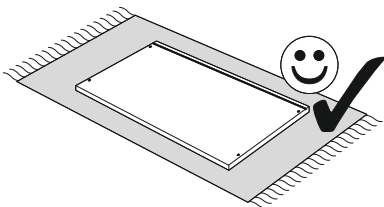

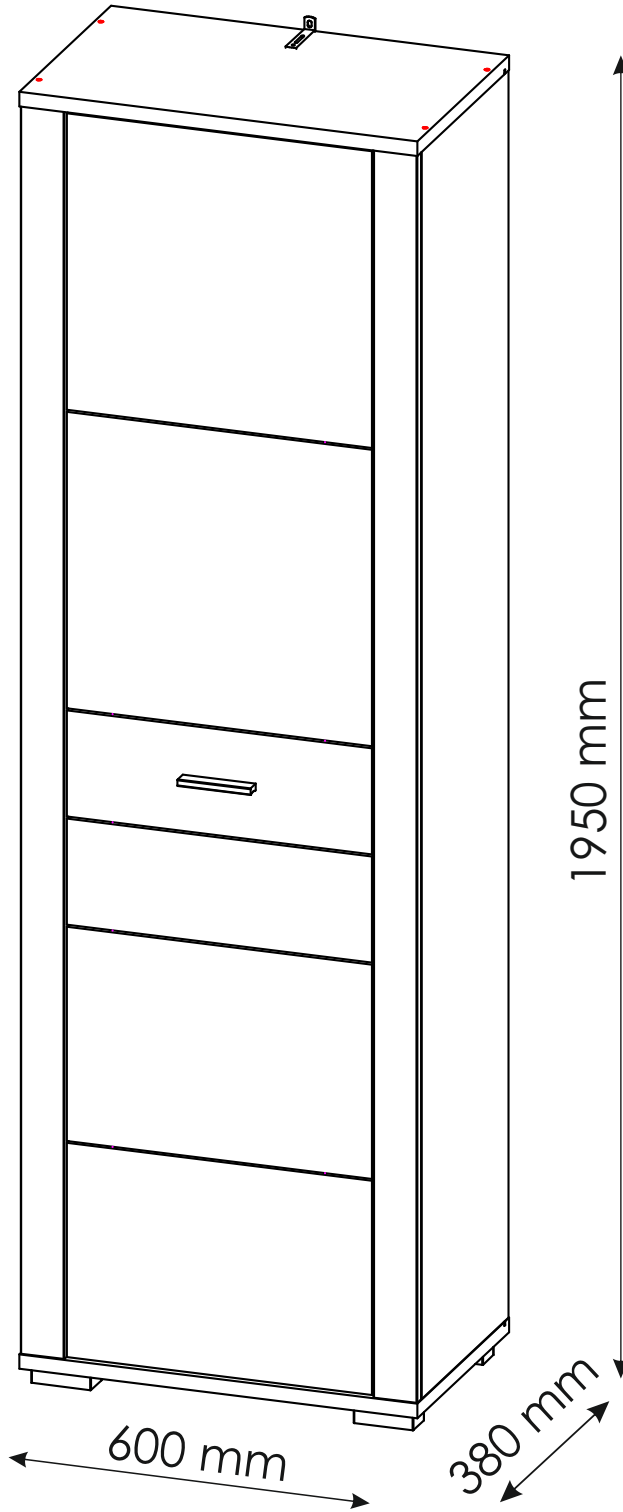
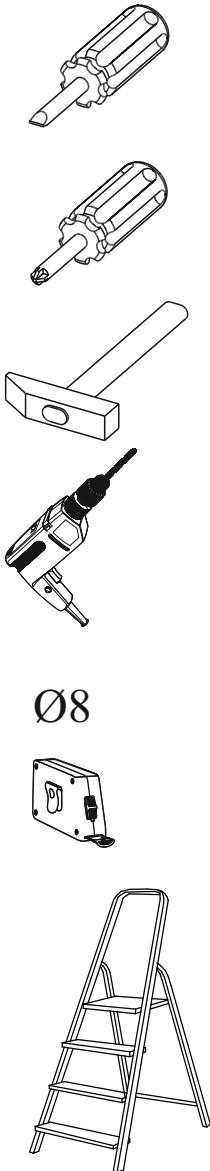
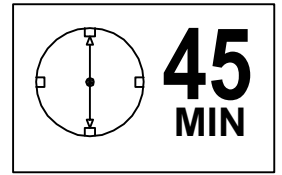
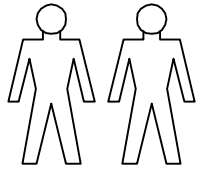
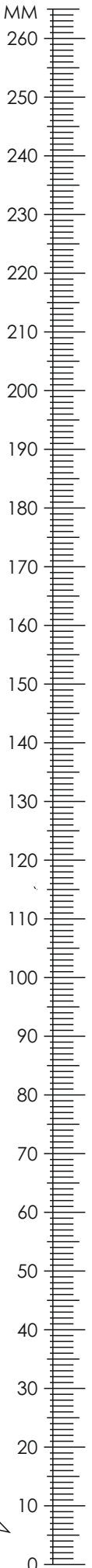



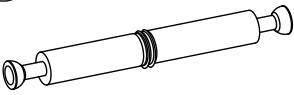

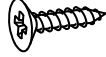



MAXIM- Garderobenschrank

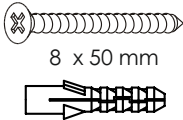
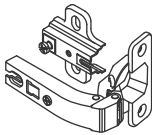

MAXIM- Garderobenschrank

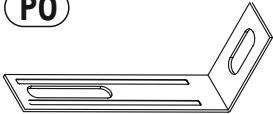
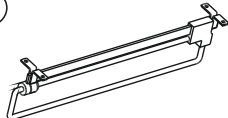
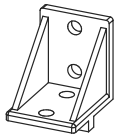
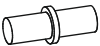

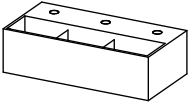
B2 f 7 x 70 mm x8 	C0  x24	C2  x4
C5  x10	D0 3 x 15 mm  x14	D10 4 x 16 mm  x8
D14 4 x 35 mm  x12	D4 3,5 x 18 mm  x40	D8 3,5 x 13 mm  x4
D21 5 x 13 mm  x1	D16 4 x 30 mm  x2	E0 5 x 50 mm 8 x 50 mm  x1
J36  x4	K 4mm  x1	L7 L-110  x1
M1  x14	P0  x1	P21  x1
P27  x10	Q0  x4	U0  x1
U10  14x8x3 x10	T2  x4	

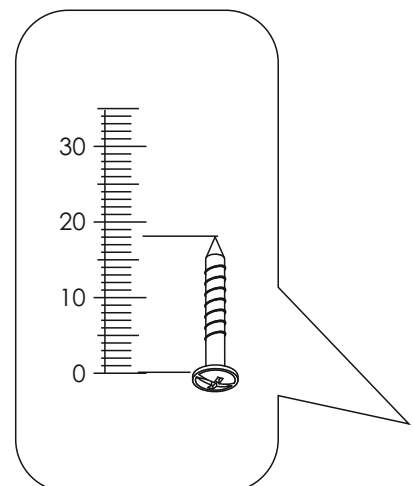

MAXIM- Garderobenschrank

1	1881	360	16	1	1/2
2	1881	360	16	1	1/2
3	600	380	22	1	2/2
4	600	380	22	1	2/2
5	566	340	16	1	1/2
6	566	340	16	1	1/2
7	460	447	16	1	2/2
8	460	447	16	1	2/2
9	460	323	16	1	2/2
10	460	323	16	1	2/2
11	460	160	16	1	2/2
12	460	160	16	1	2/2
13	1880	66	16	1	1/2
14	1880	66	16	1	1/2
15	1893	289	3	2	1/2
16					2/2

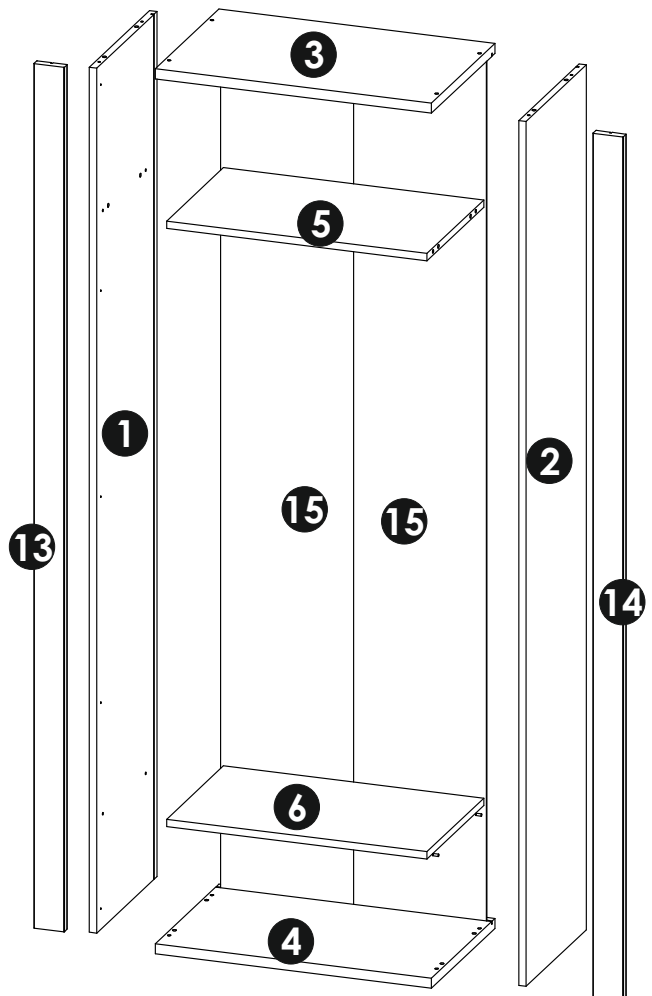
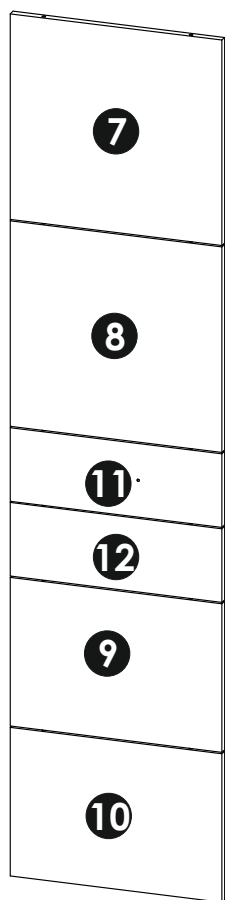

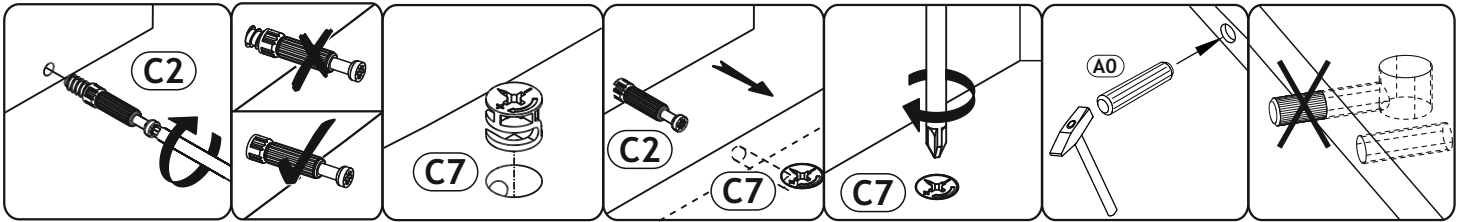

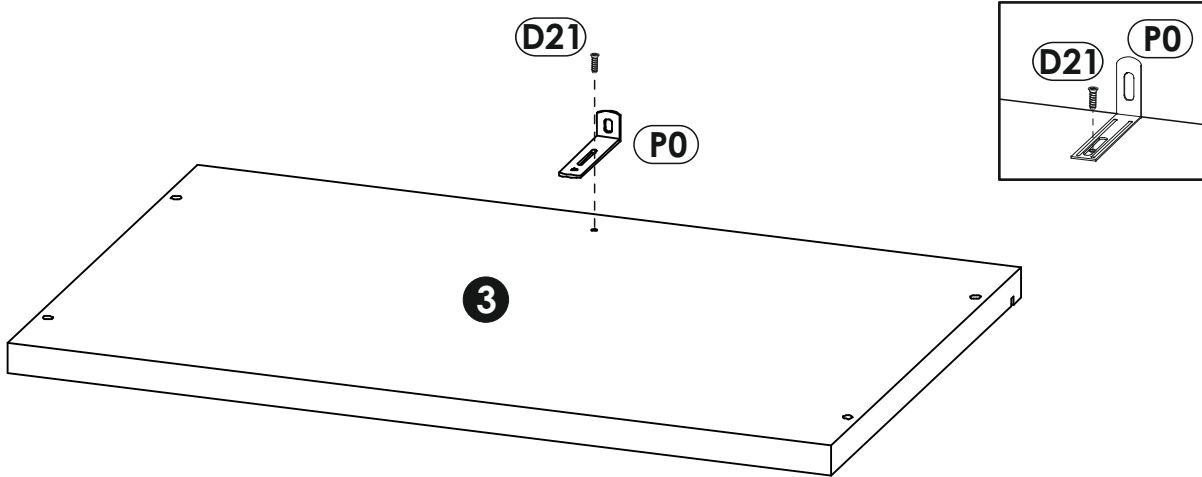
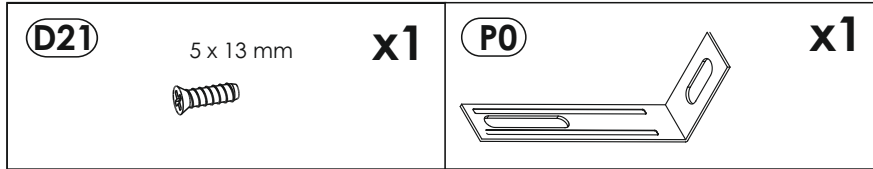

1 ▶

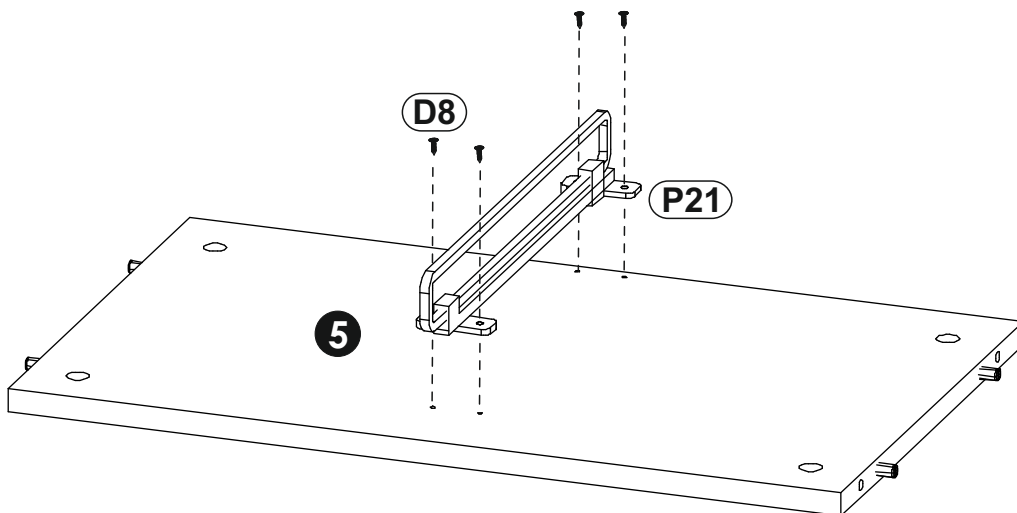
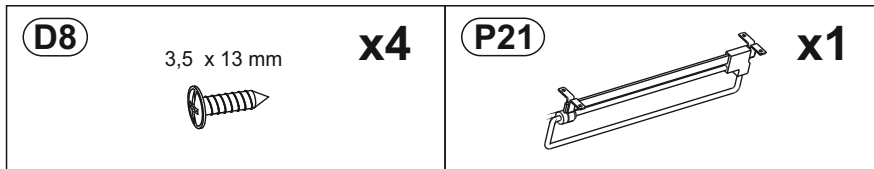

2 ▶

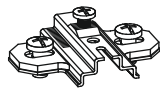

3 L

D4 3,5 x 18 mm 	x20	P27 	x10	J36 	x4
---	------------	--	------------	---	-----------

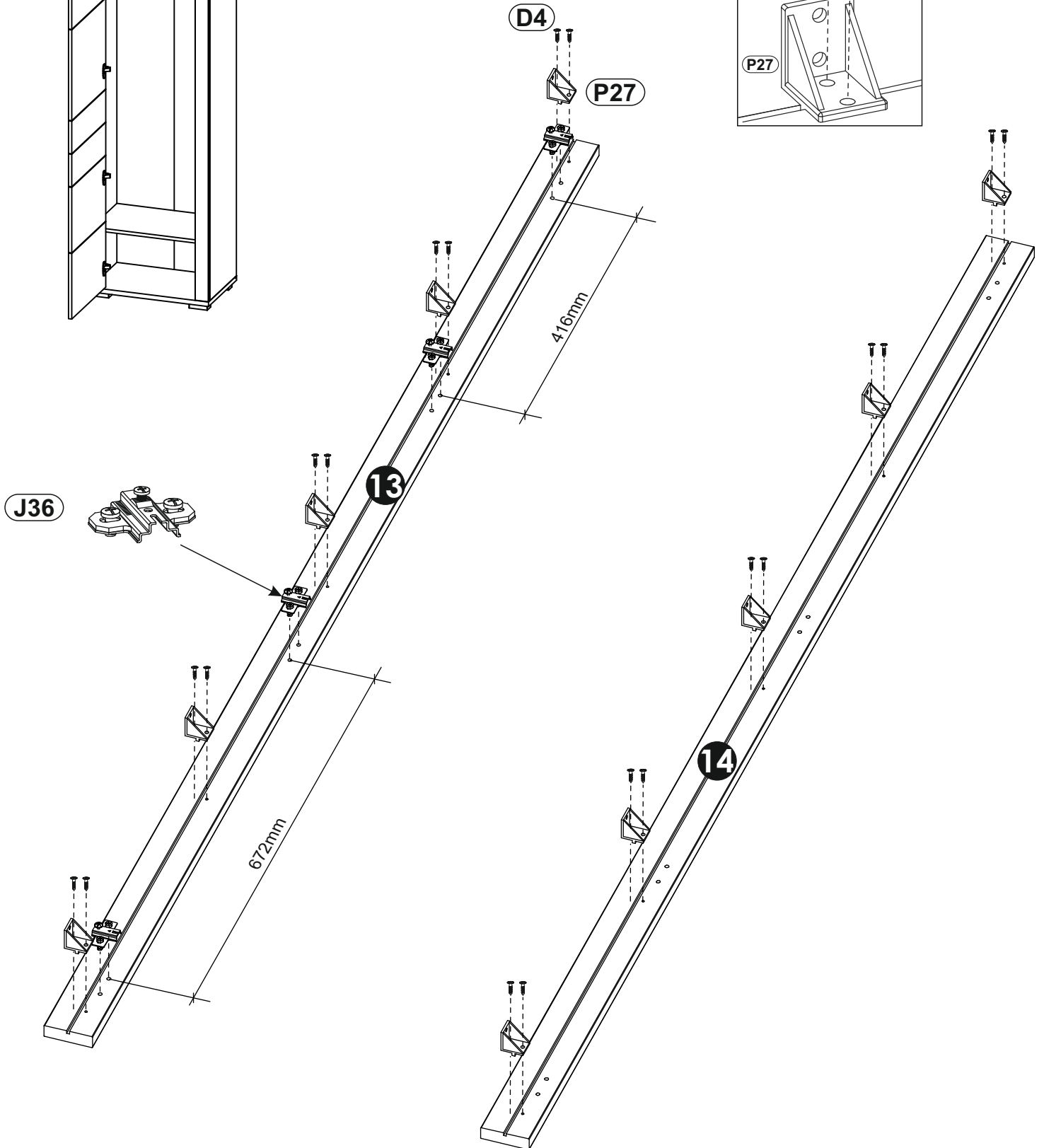
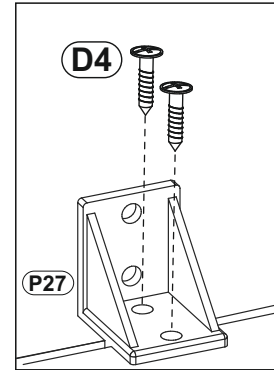
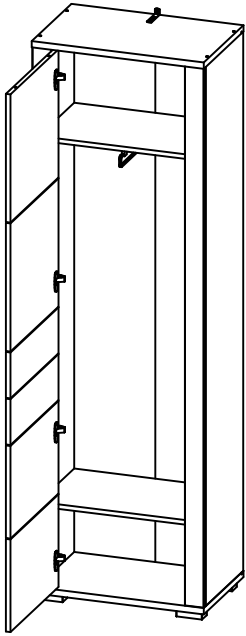

3 P ▶

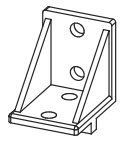
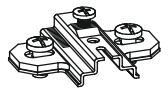
D4 3,5 x 18 mm 	x20	P27 	x10	J36 	x4
---	------------	--	------------	---	-----------

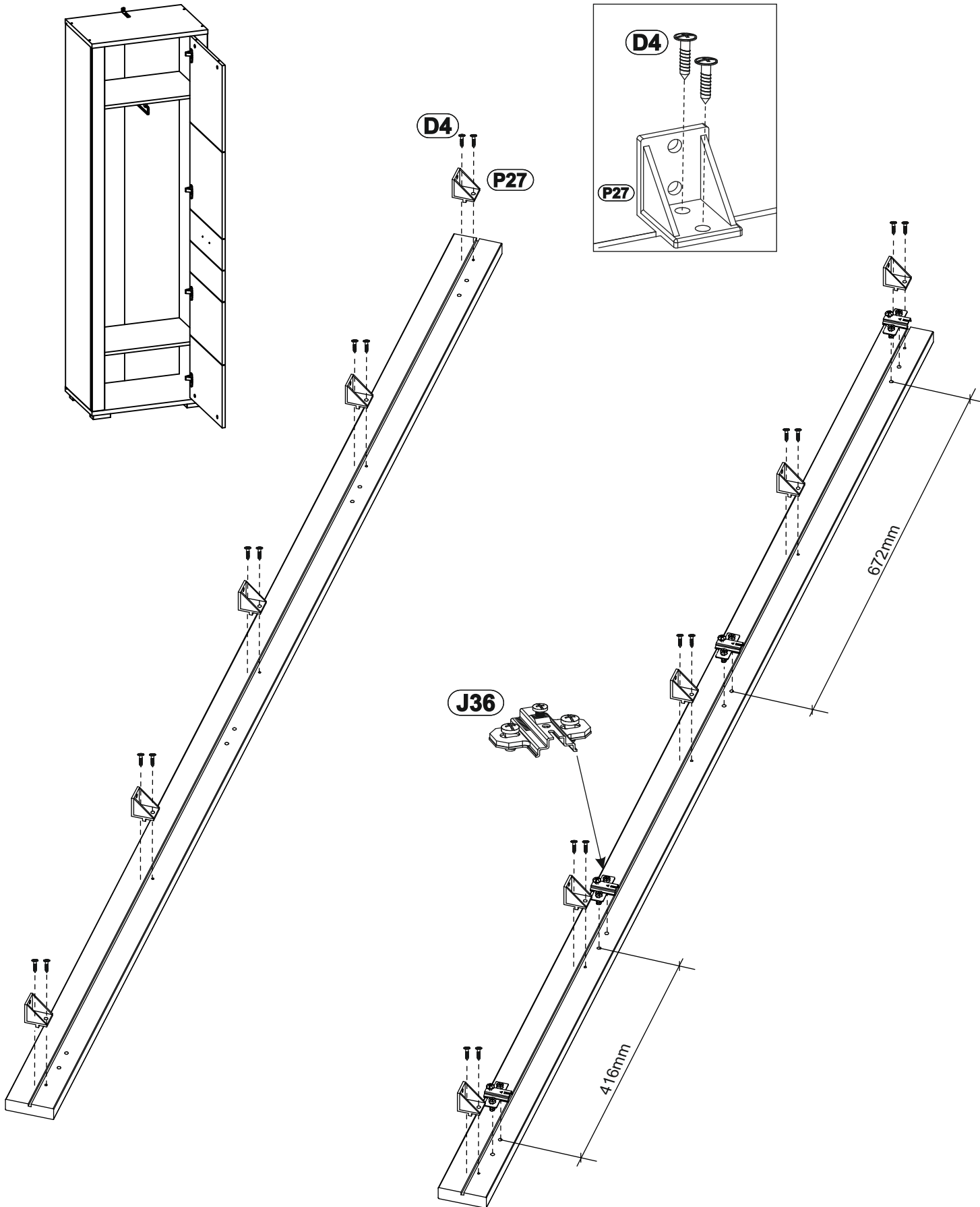

4 ▶

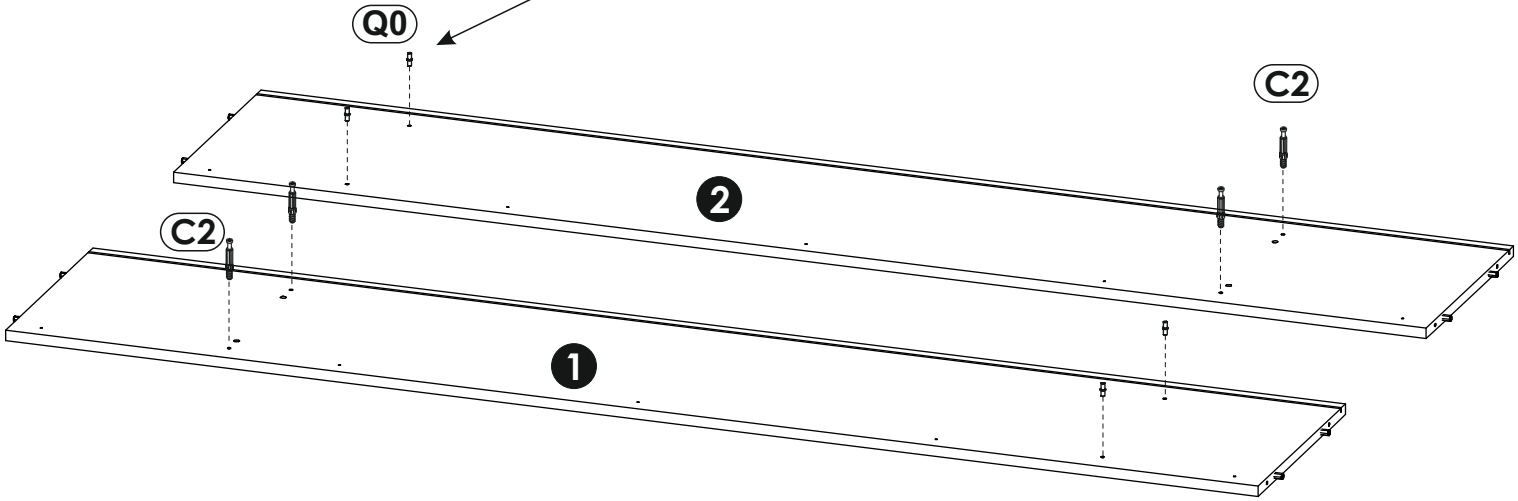
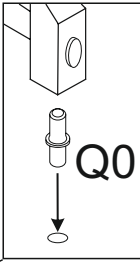
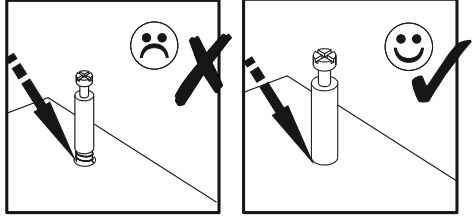
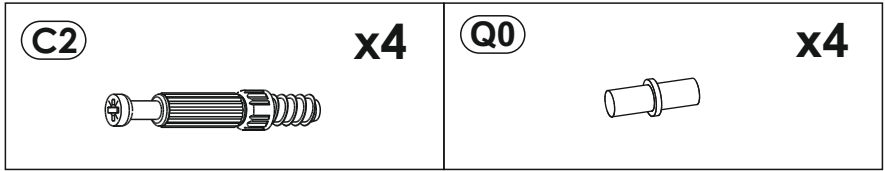

5 ▶

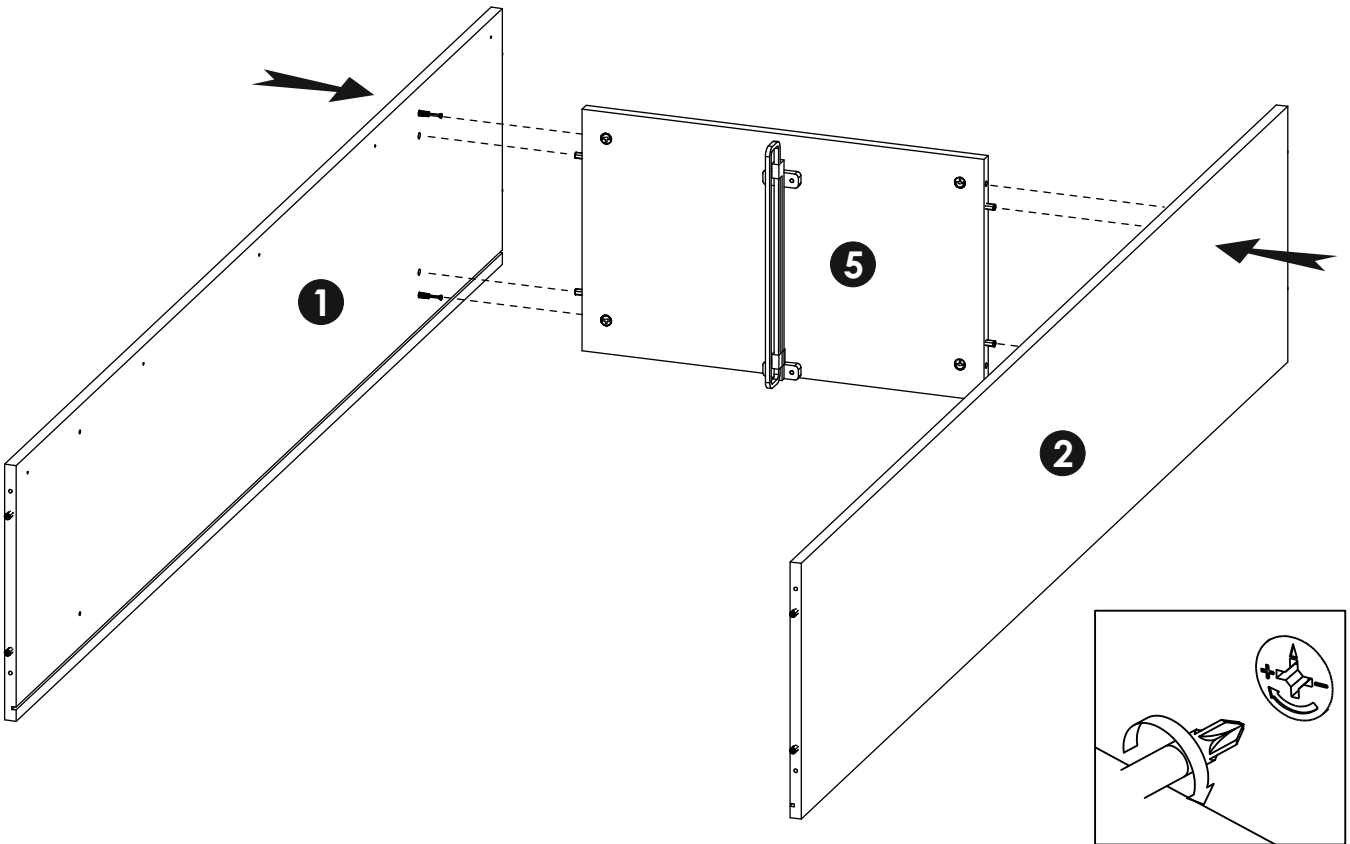



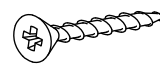
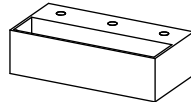

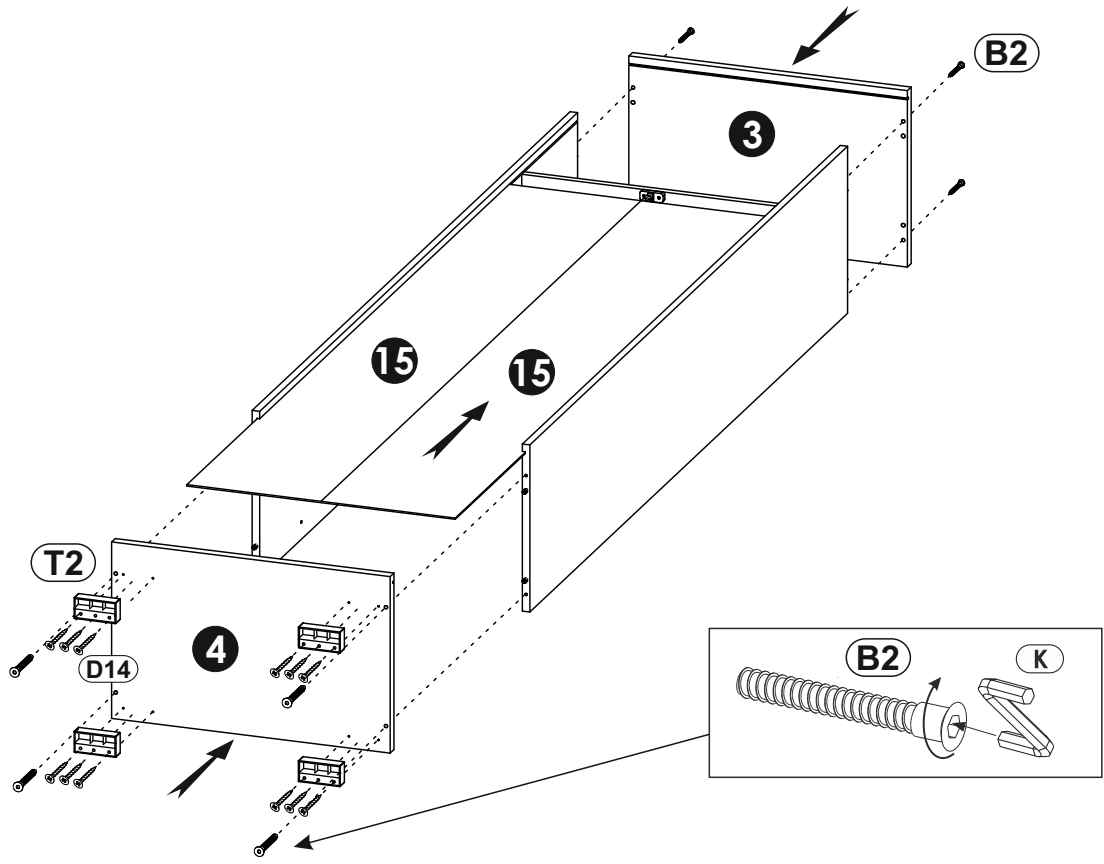

6 ▶

<p>(B2) f 7 x 70 mm x8</p> 	<p>(D14) 4 x 35 mm x12</p> 	<p>(T2) x4</p> 
--	--	---

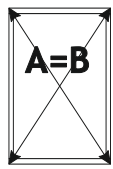

7 ▶

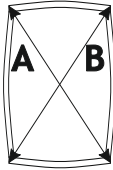
<p>(D0) 3 x 15 mm x14</p> 	<p>(M1) x14</p> 
---	---



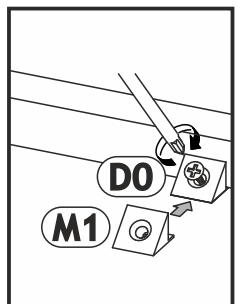
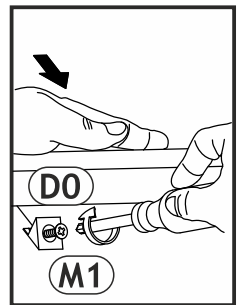
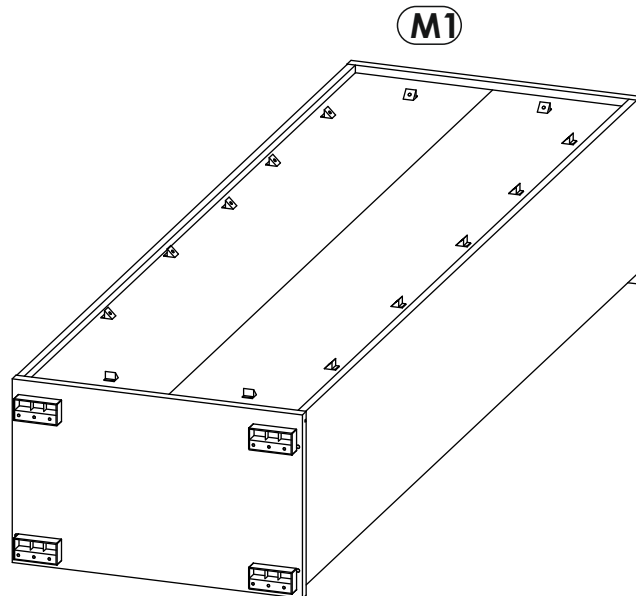



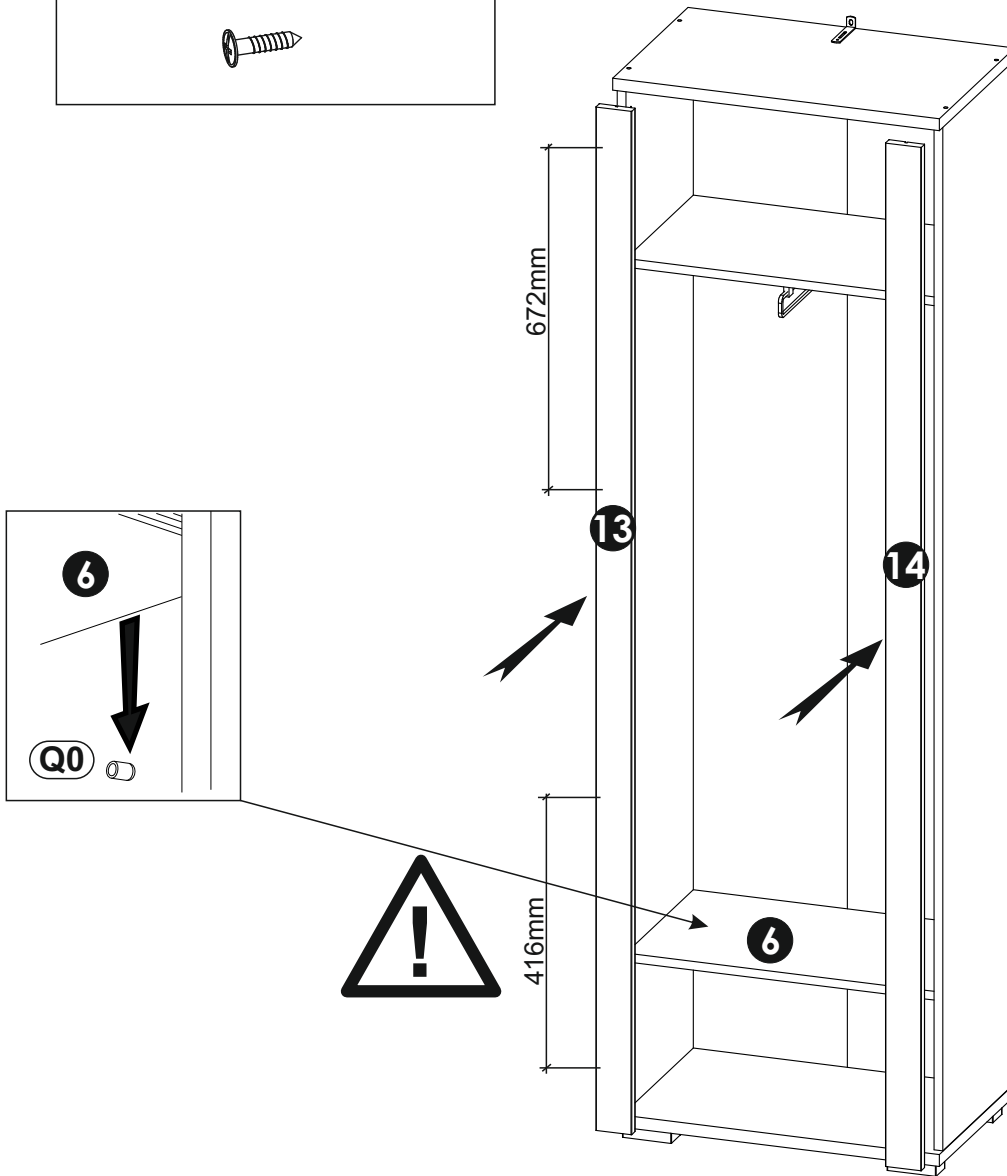
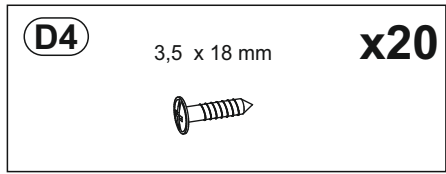

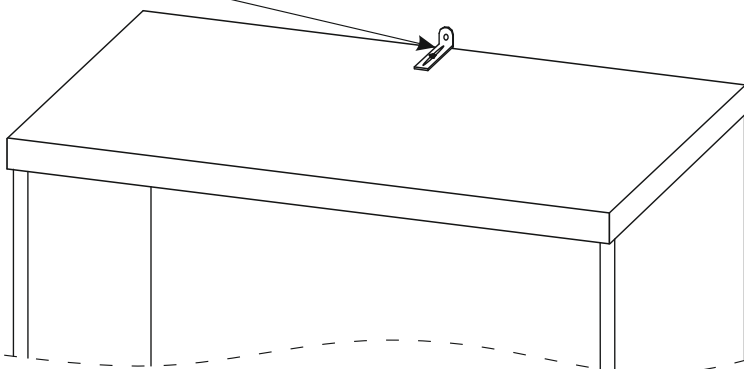
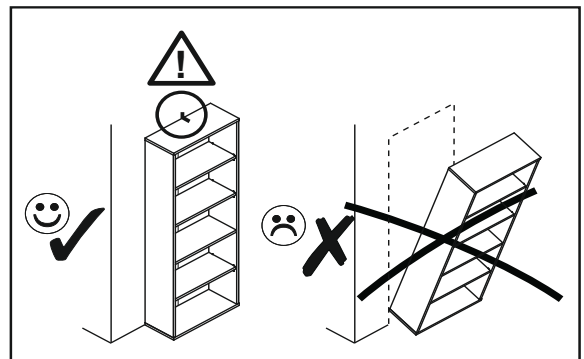
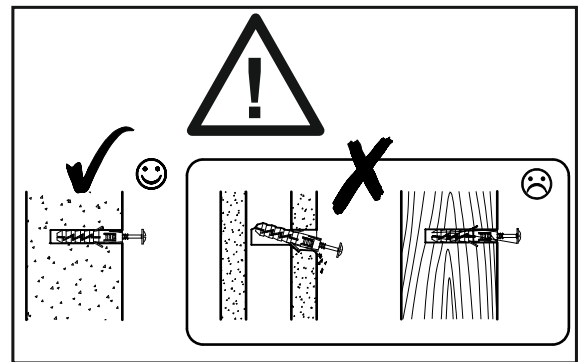
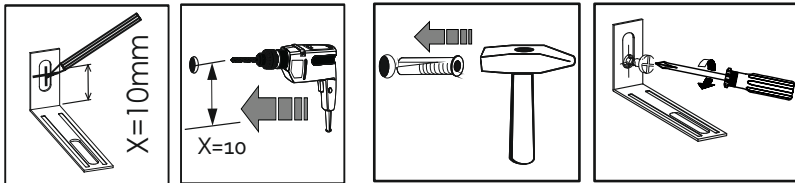
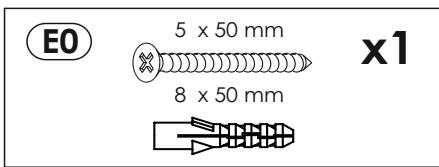

8 ▶



9 ▶



10L ▶

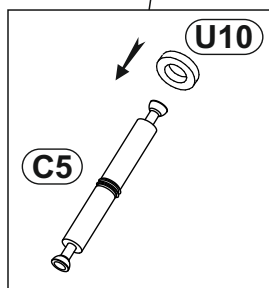
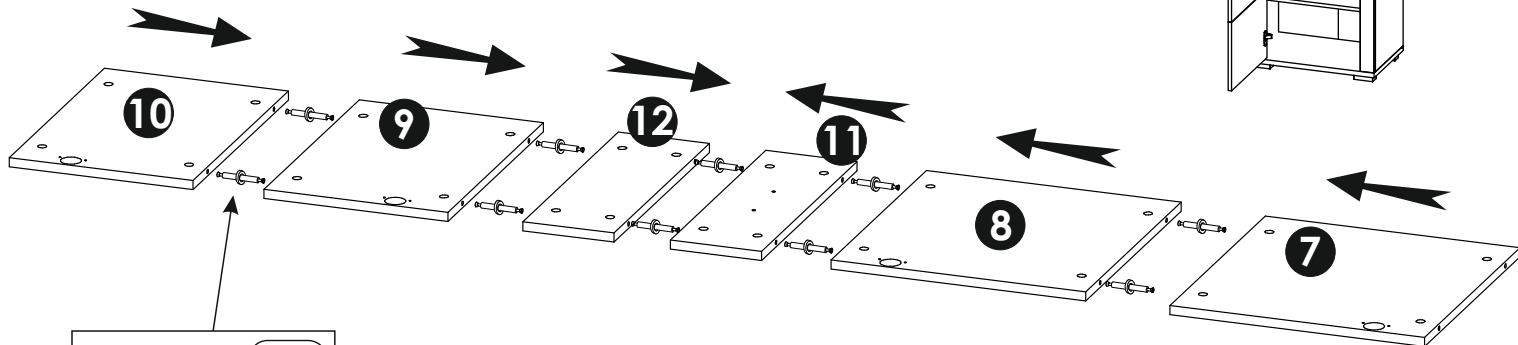
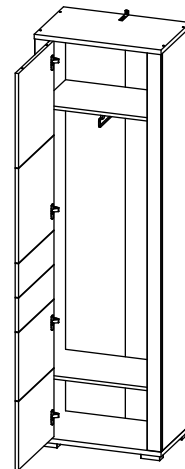
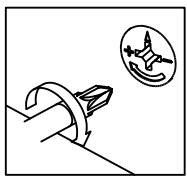
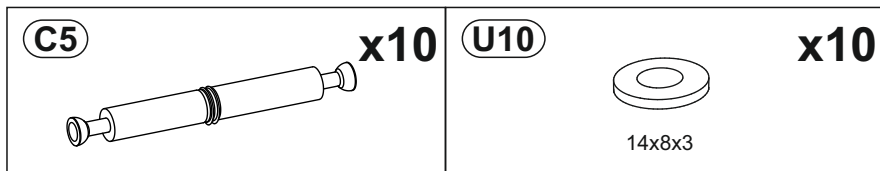

11L ▶

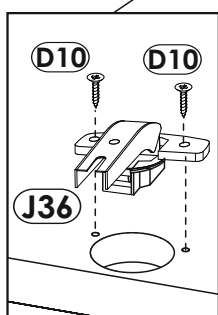
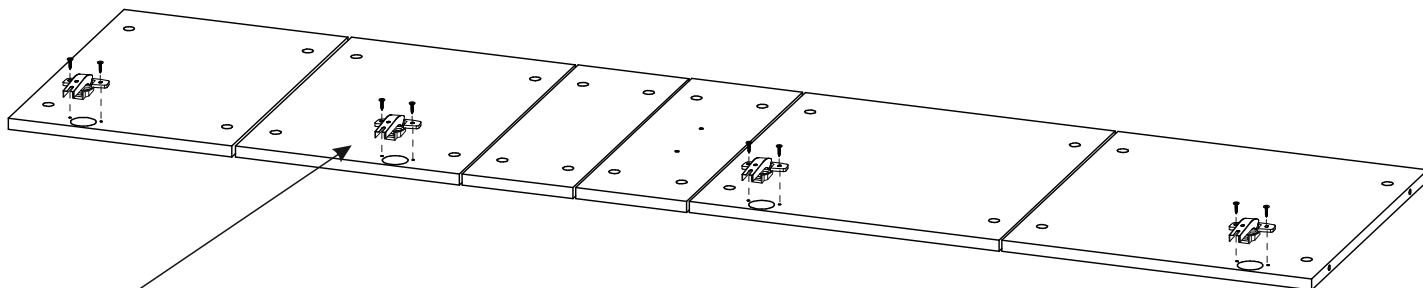
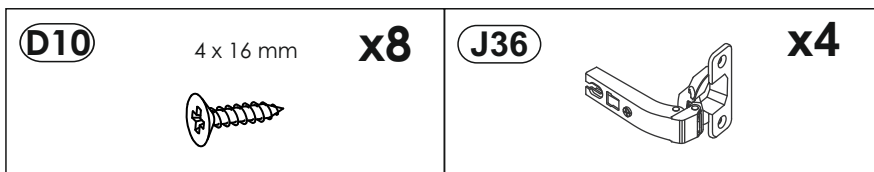

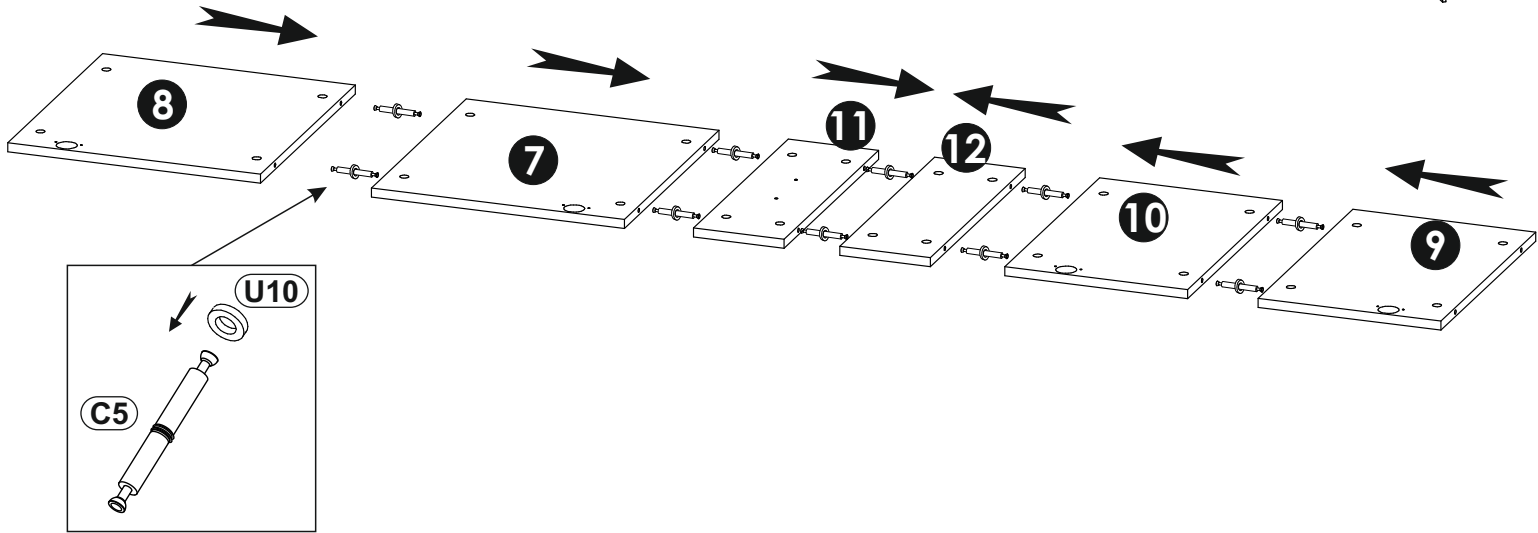
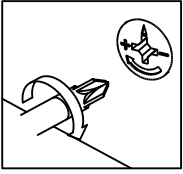
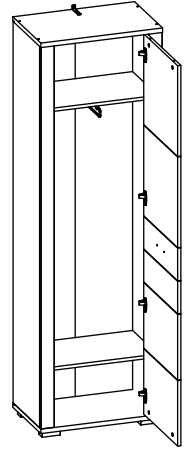
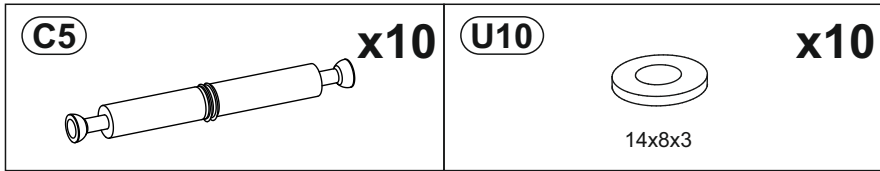

10P ▶

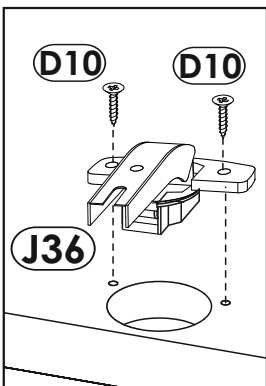
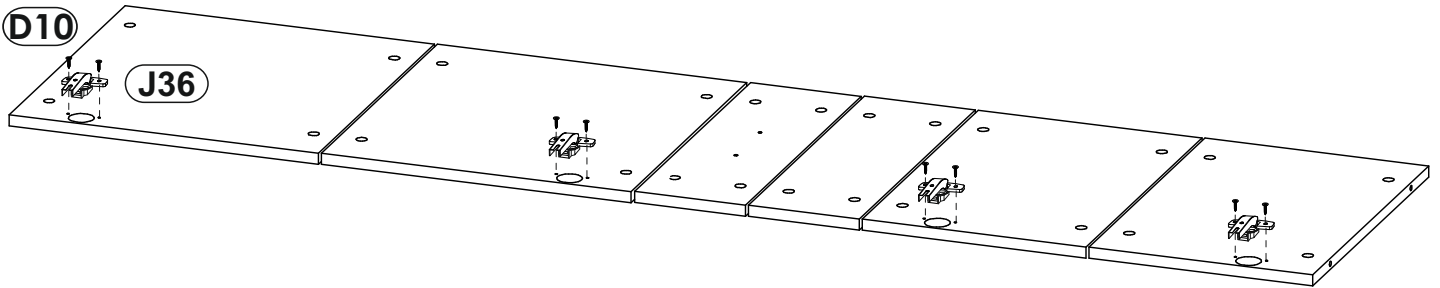
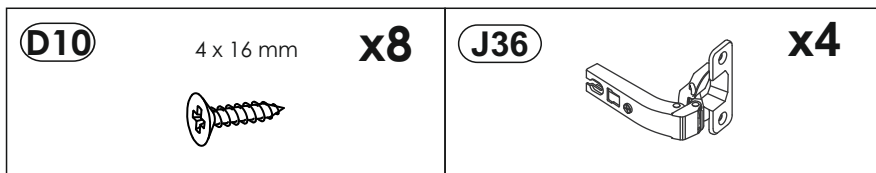

11P ▶



12 ▶

(C0)  x24	(D16)  4 x 30 mm x2	(L7)  L-110 x1
--	---	--

(U0)  x1

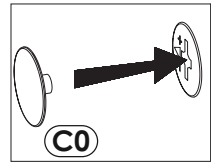

L

R

