

# CAMRON-Aktenschrank klein 1T 00030001/52

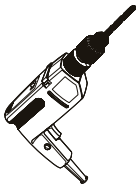

Ø8

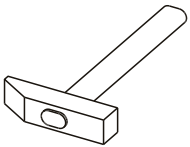

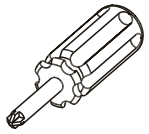
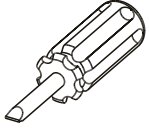
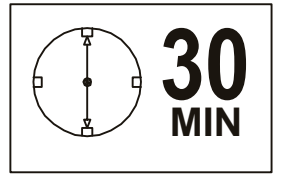
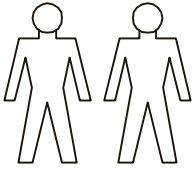

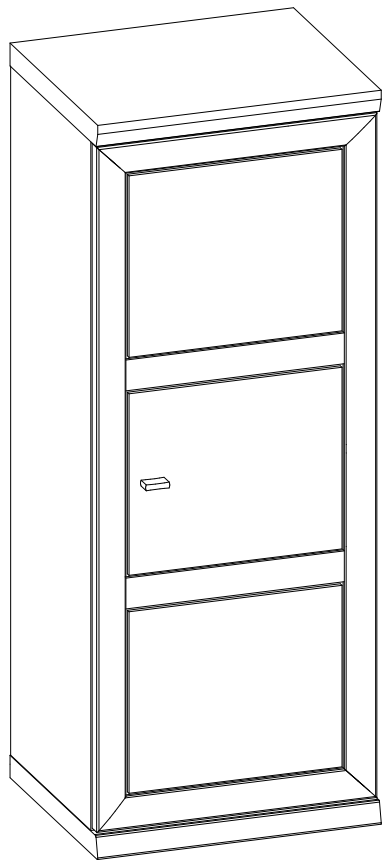



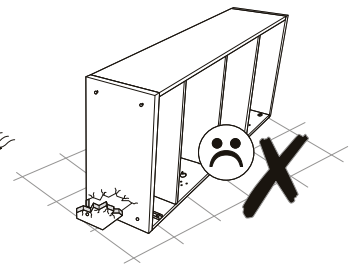
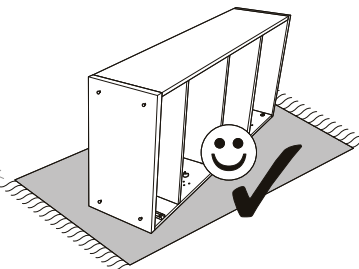
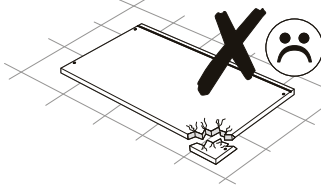
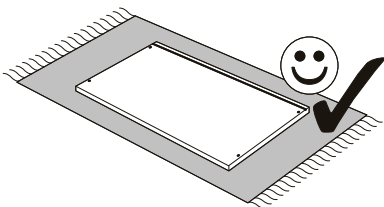
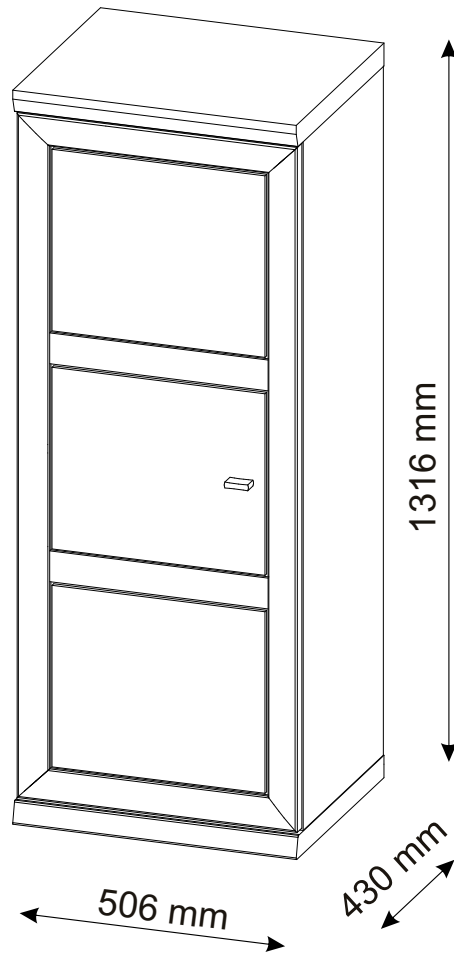



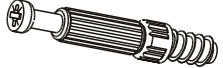



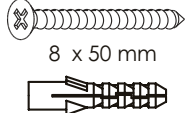

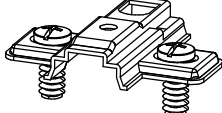
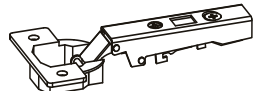
R

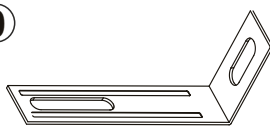

L

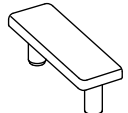

<b>B0</b>		<b>x4</b>	<b>B6</b>	f 7 x 38 mm 	<b>x4</b>	<b>C0</b>		<b>x4</b>
<b>C2</b>		<b>x8</b>	<b>D0</b>	3x15mm 	<b>x10</b>	<b>D10</b>		<b>x6</b>
<b>D21</b>	5x13mm 	<b>x1</b>	<b>E0</b>	5 x 50 mm 8 x 50 mm 	<b>x1</b>	<b>H2</b>		<b>x2</b>
<b>J3</b>		<b>x3</b>	<b>J10</b>		<b>x3</b>	<b>K</b>	4mm 	<b>x1</b>
<b>L6</b>		<b>x1</b>	<b>M1</b>		<b>x10</b>	<b>P0</b>		<b>x1</b>
<b>Q3</b>		<b>x8</b>	<b>T4</b>		<b>x4</b>	<b>U3</b>		<b>x2</b>

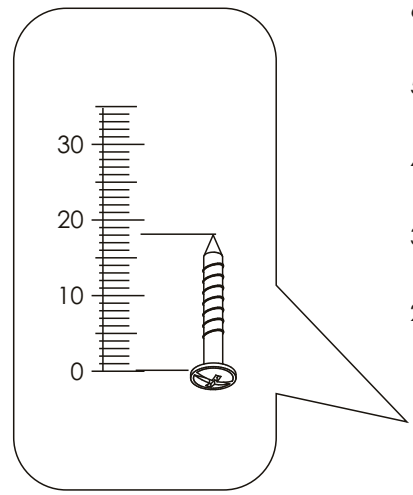
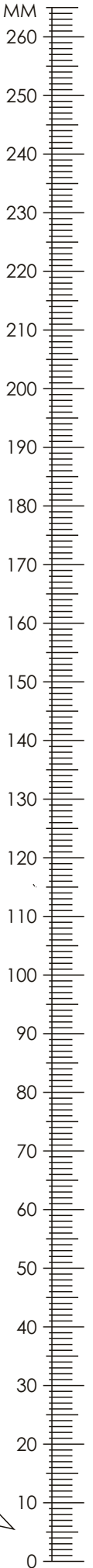

<b>1</b>	1230	393	16	x1	1/3
<b>2</b>	1230	393	16	x1	1/3
<b>3</b>	472	393	16	x1	1/3
<b>4</b>	506	430	40	x1	3/3
<b>5</b>	506	430	40	x1	3/3
<b>6</b>	1224	482	3	x1	2/3
<b>7</b>	472	372	16	x2	1/3
<b>8</b>	1222	500	25	x1	2/3
					3/3

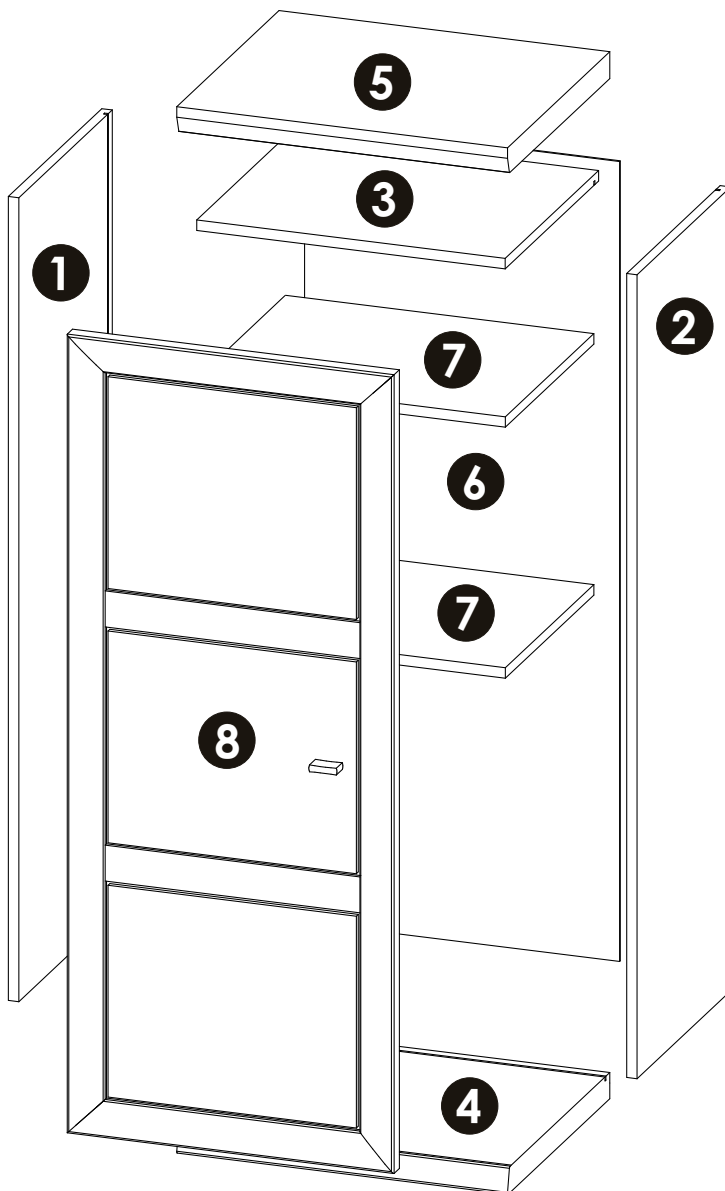
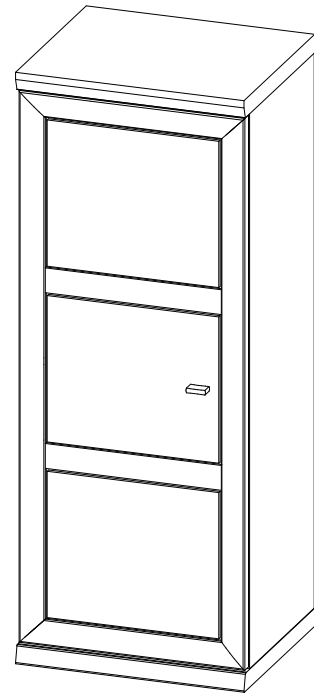

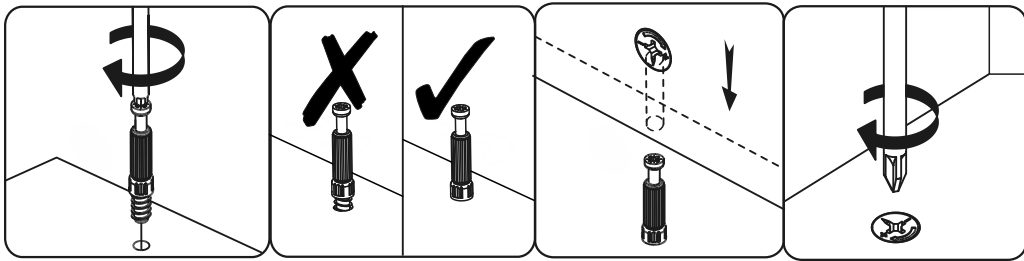

1 ▶

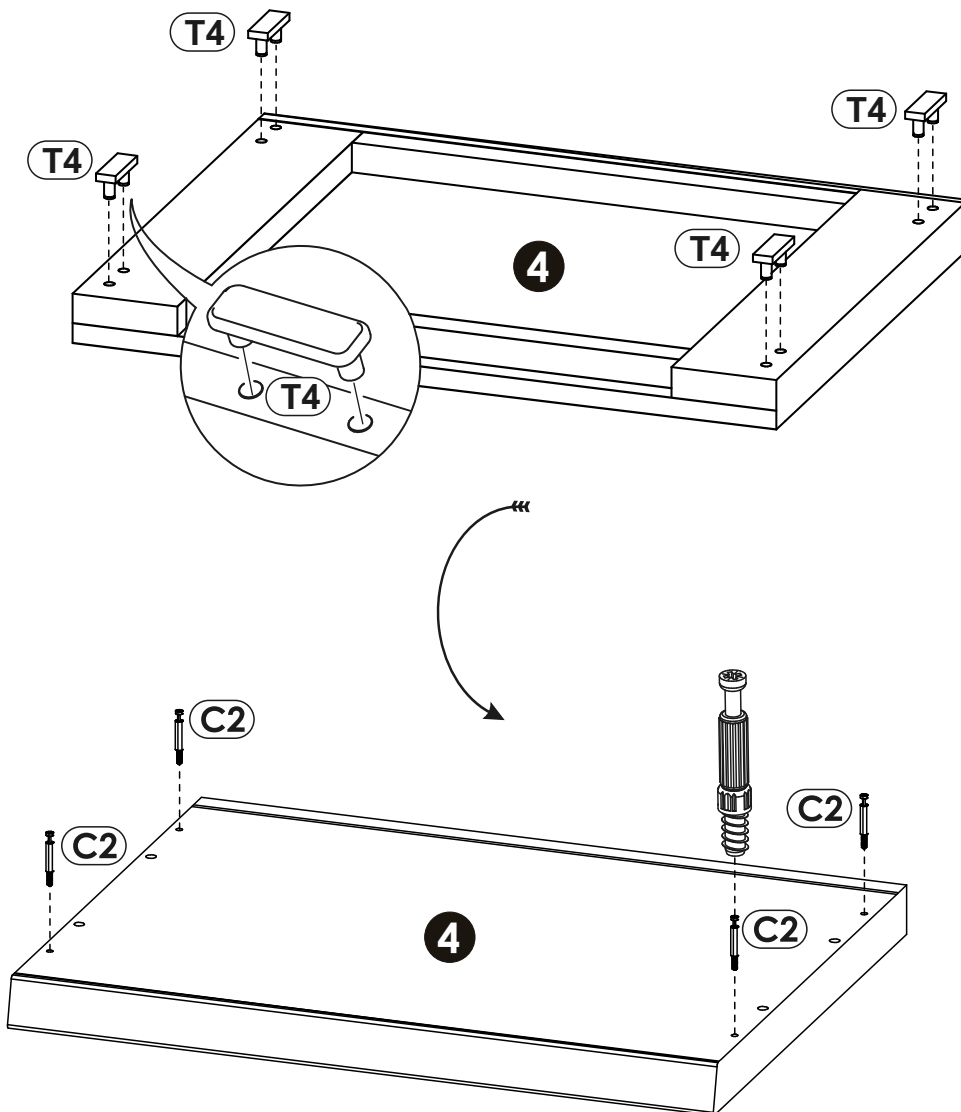
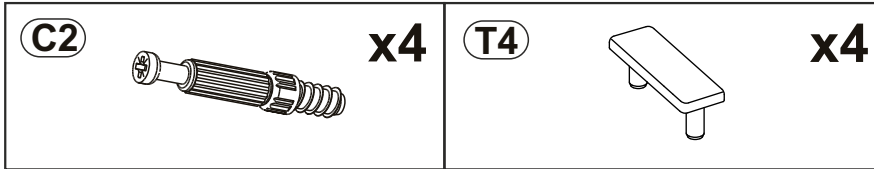

2 ▶

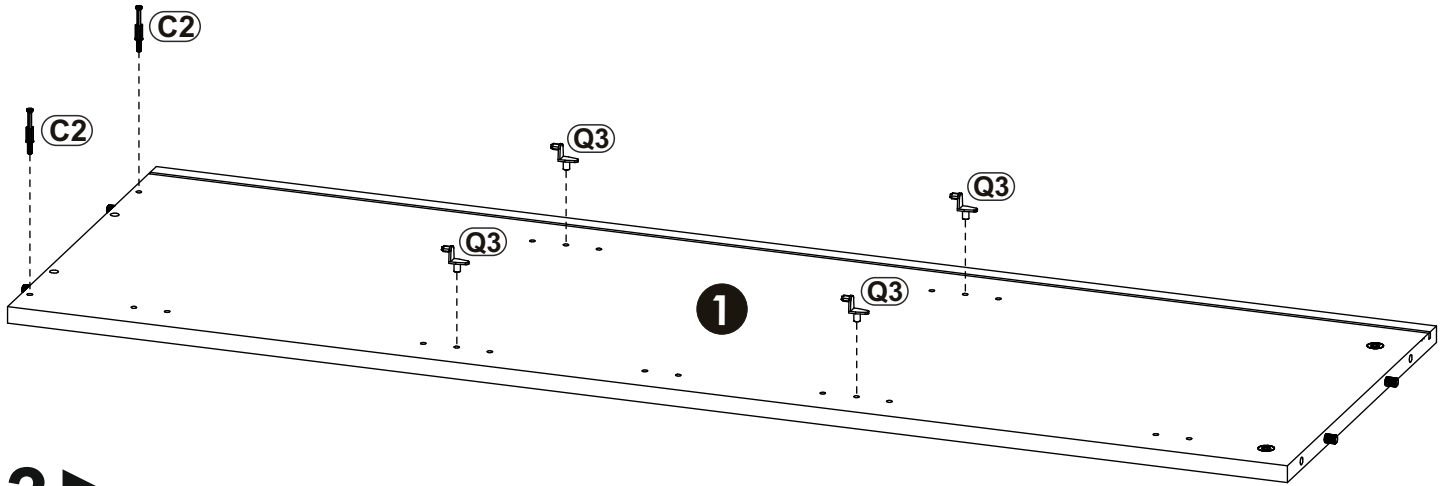
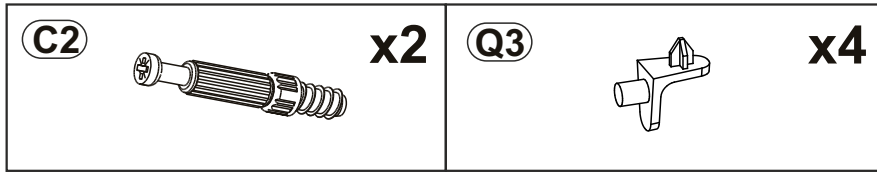

3 ▶

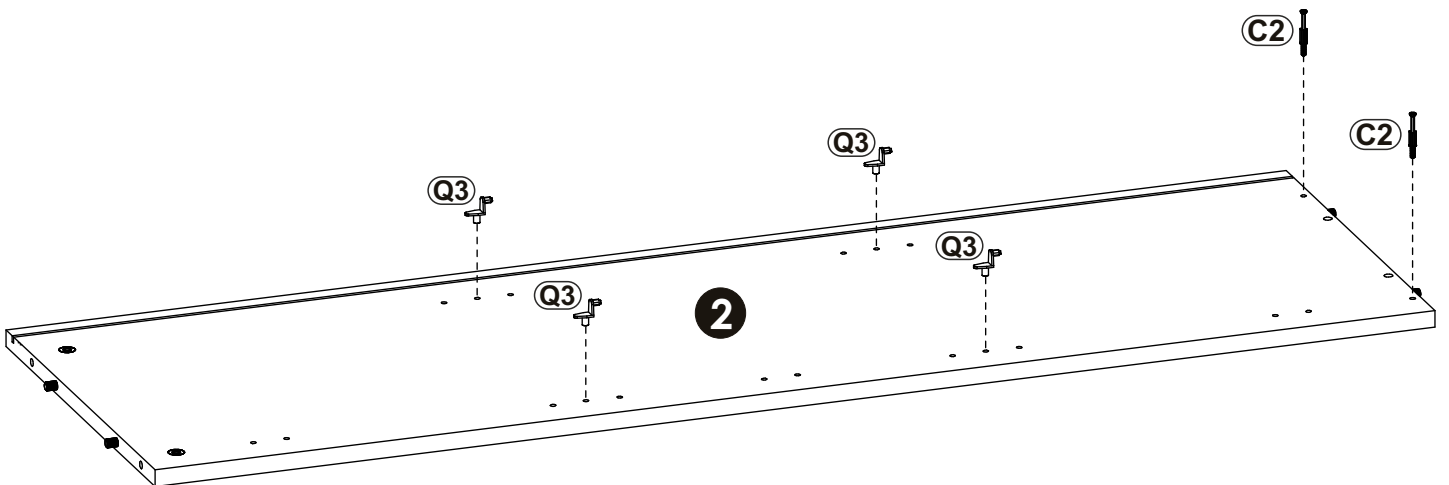
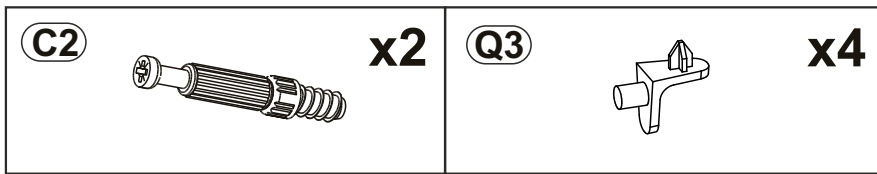

4 ▶

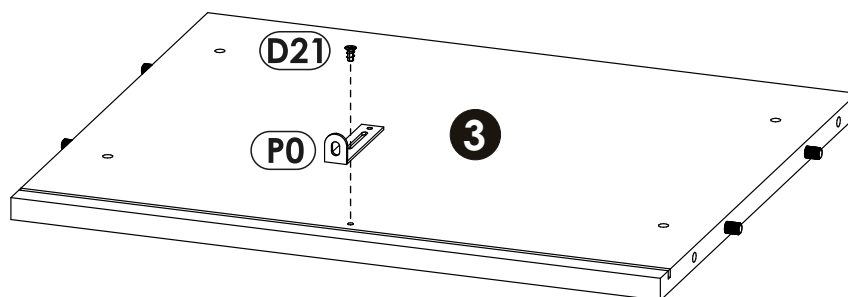
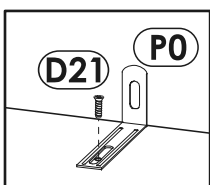
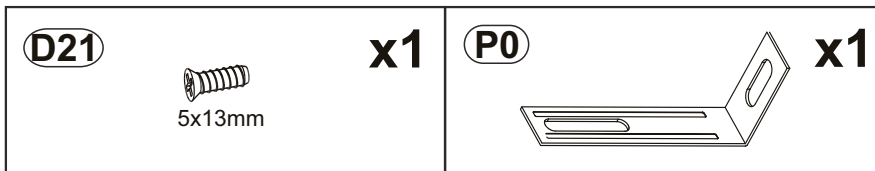

5 ▶

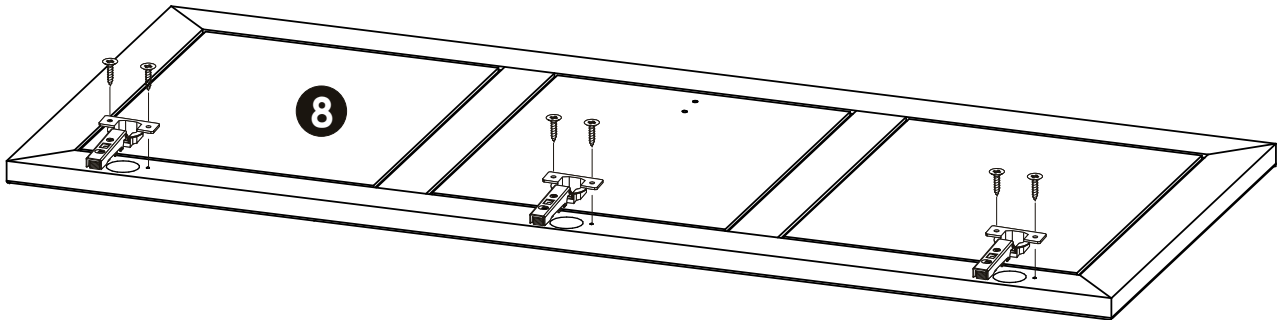
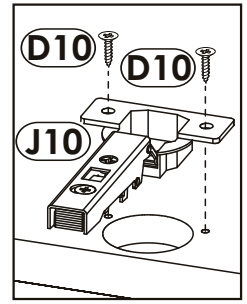
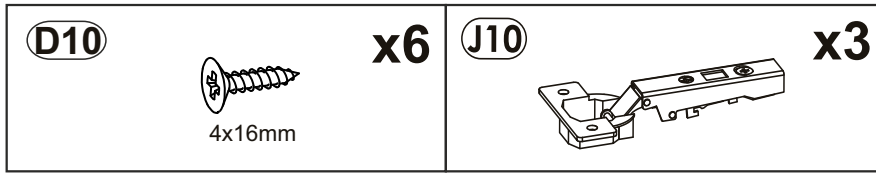

6 ▶

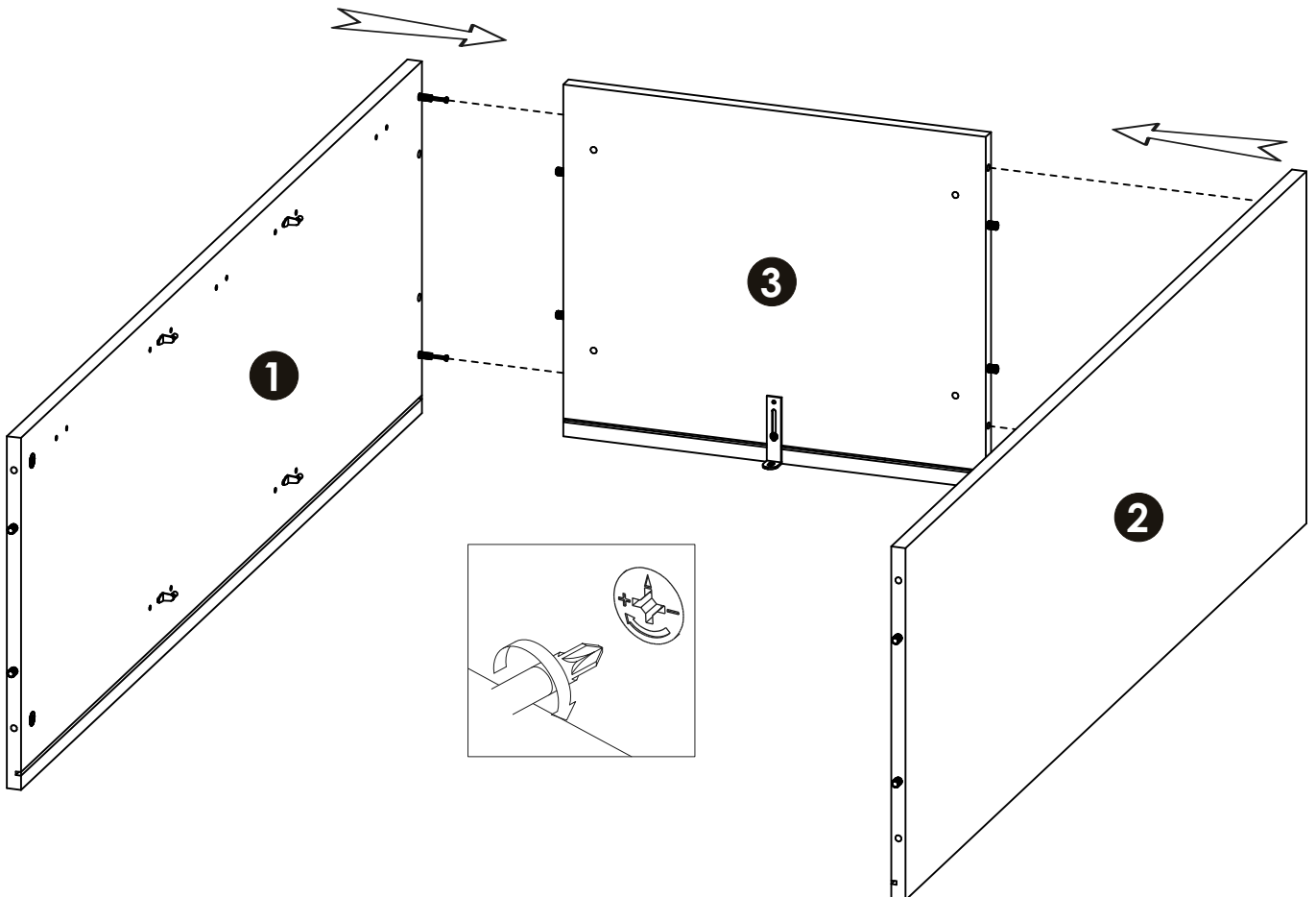

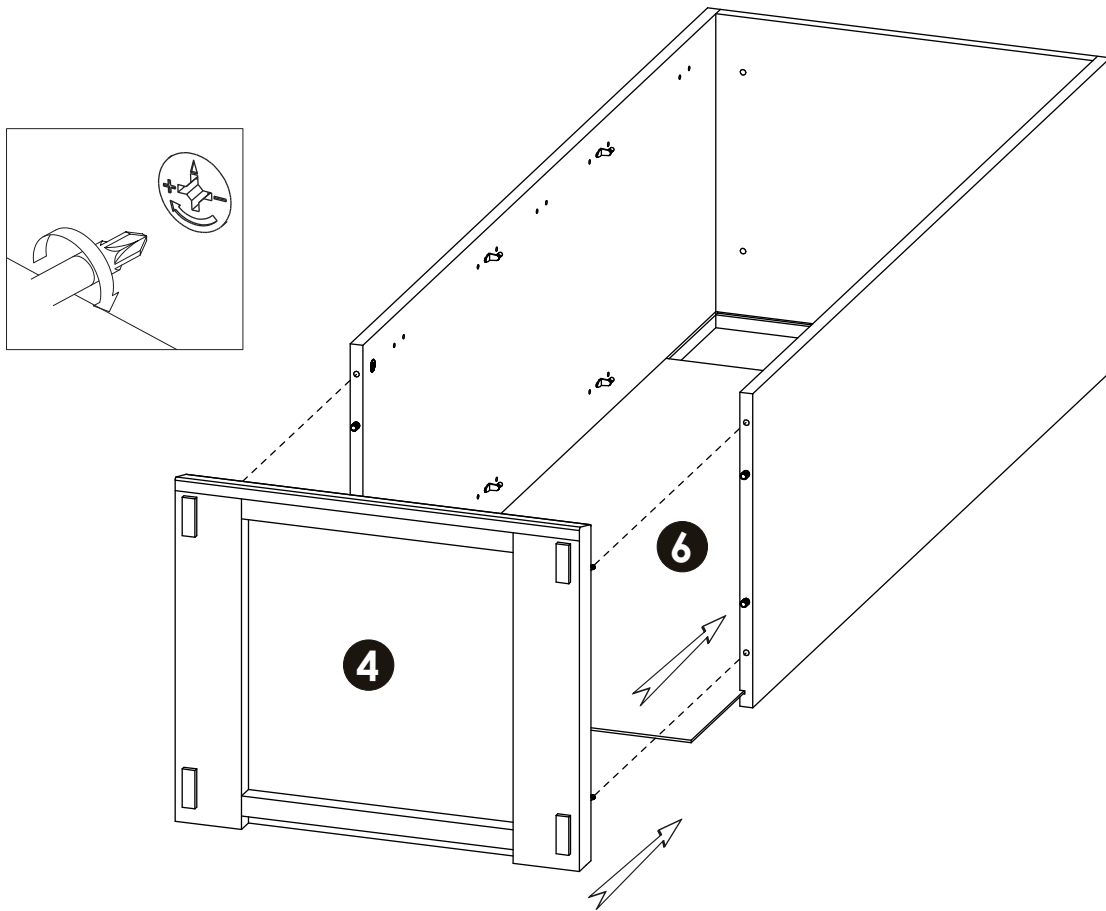

7 ▶

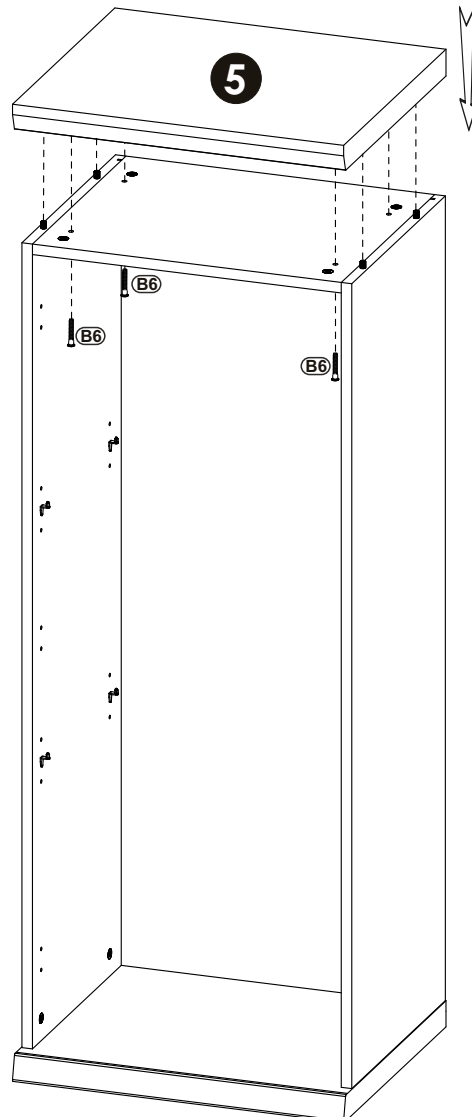
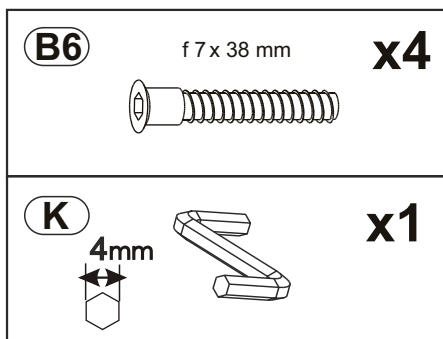

8 ▶



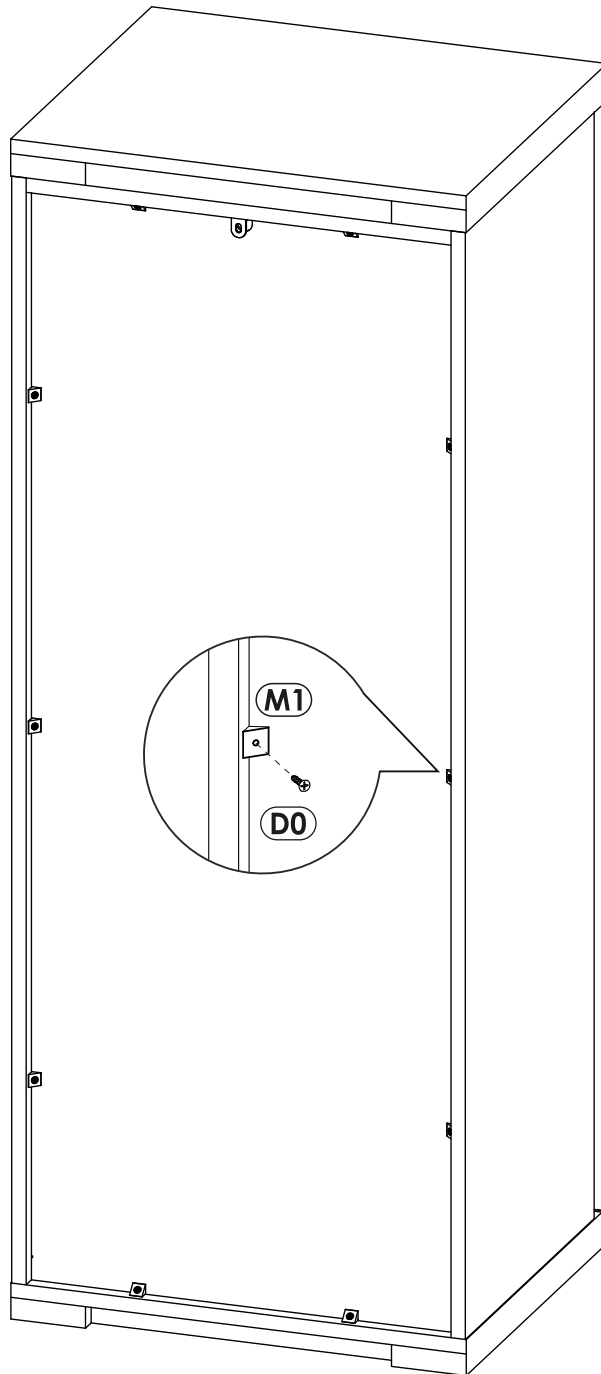
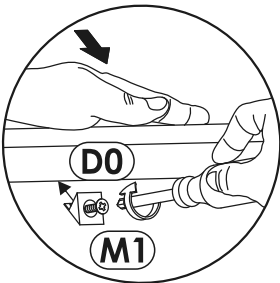
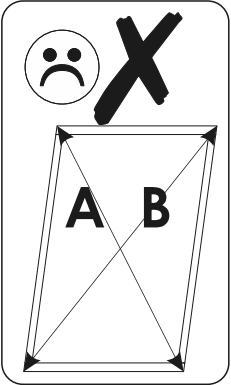
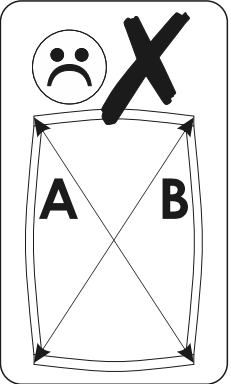
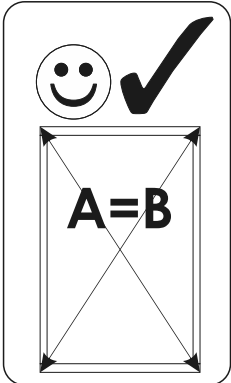

9 ▶

<b>D0</b>	 3x15mm	<b>x10</b>	<b>M1</b>		<b>x10</b>
-----------	---	------------	-----------	---	------------





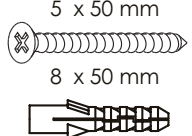

# 10 ▶

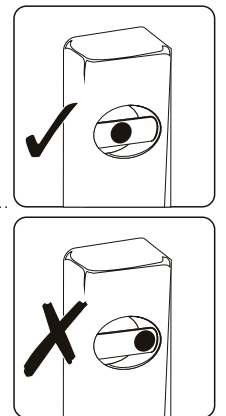
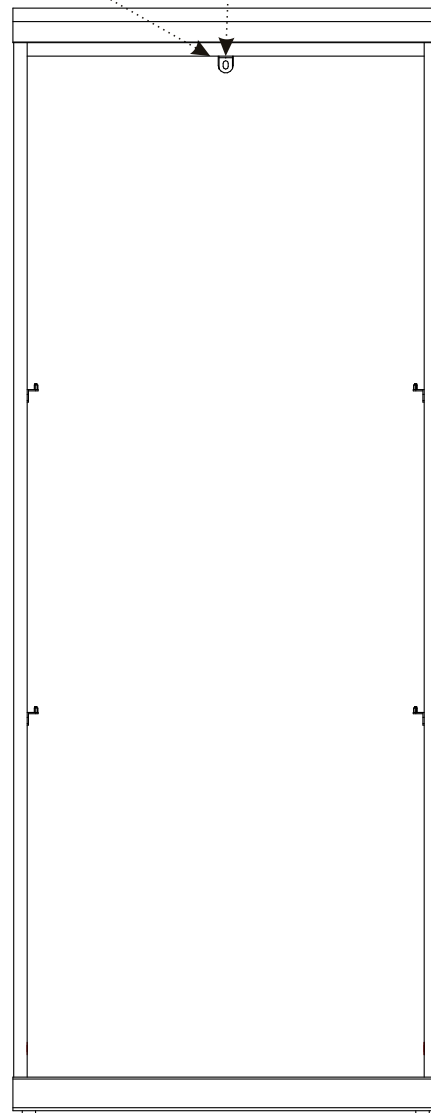
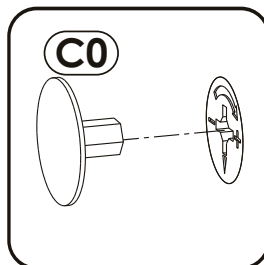
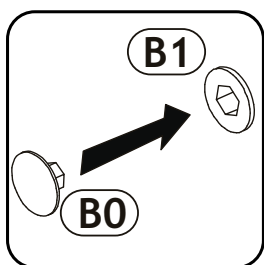
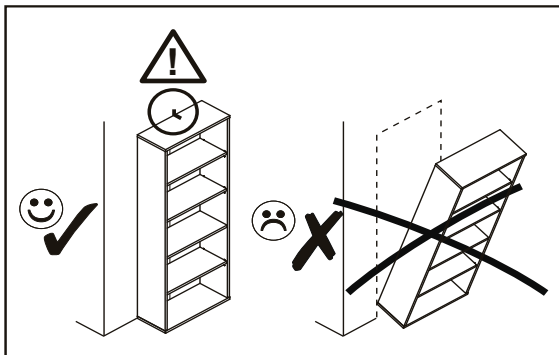
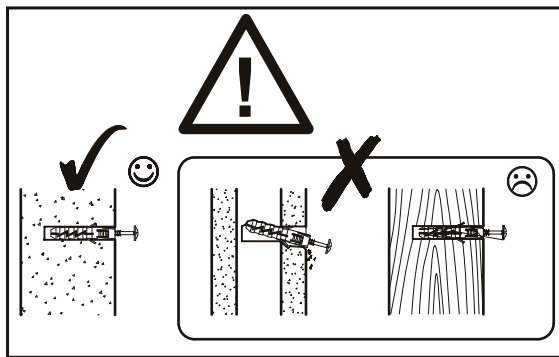
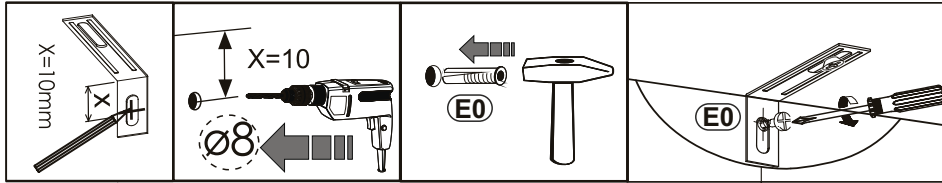
<b>B0</b>  <b>x4</b>	<b>C0</b>  <b>x4</b>	<b>E0</b>  <b>x1</b>
---	---	---

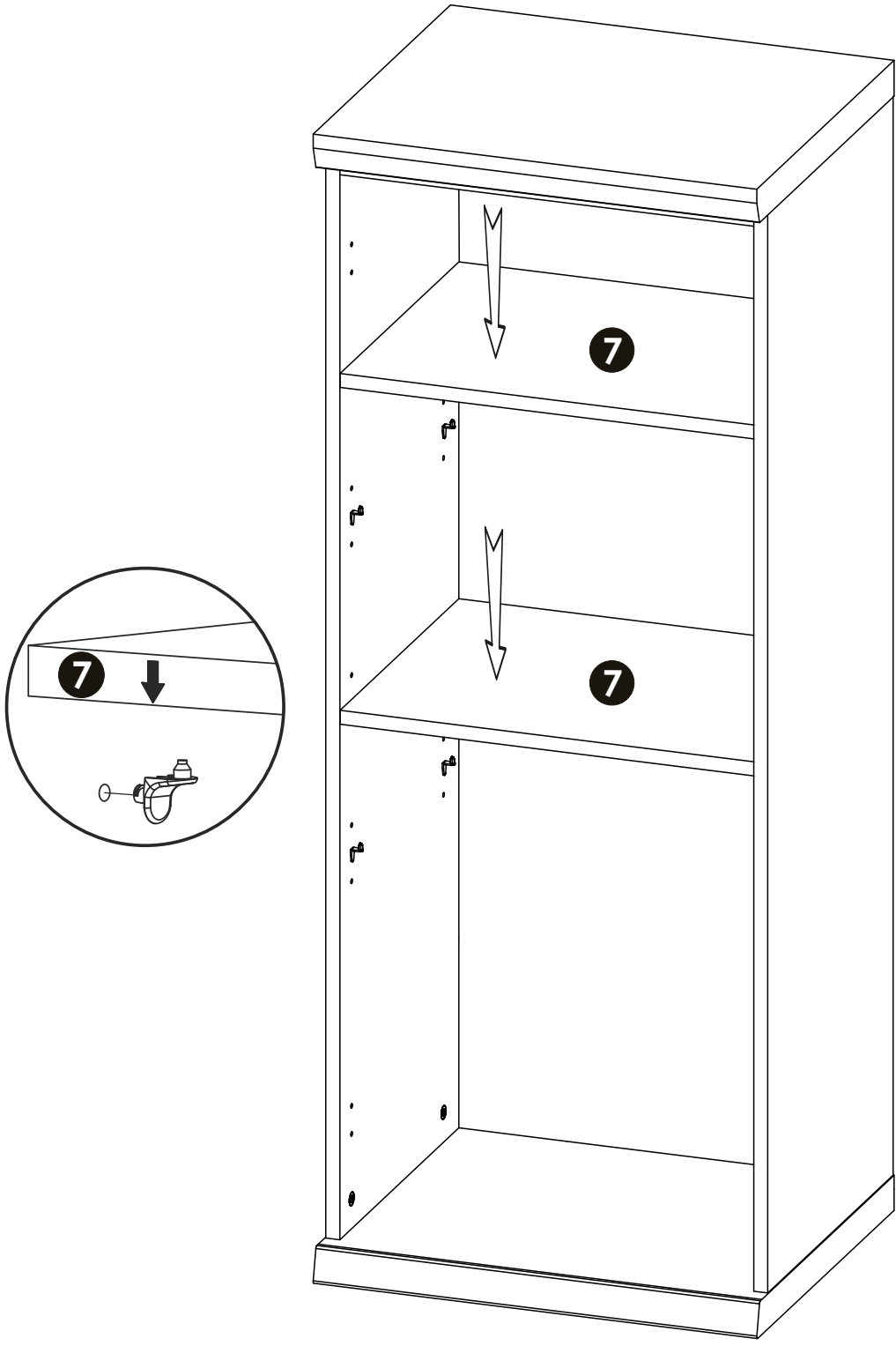

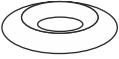

# 12 ▶

<b>(H2)</b>  4x22mm <b>x2</b>	<b>(L6)</b>  <b>x1</b>	<b>(U3)</b>  <b>x2</b>
---	---	---

**(J3)** **x3**

