

LKZ 85020

Modellnummer / Number / Numéro du modèle
 Numero / Номер на модела / modello
 Číslo modelu / Modell száma / Eíslo modelu
 Številka modela / Număr model / Broj modela
 Modelnummer / Numer modelu

Type / Tipo / Típus / Typ / Тип / Tip

715

X5W ## 715

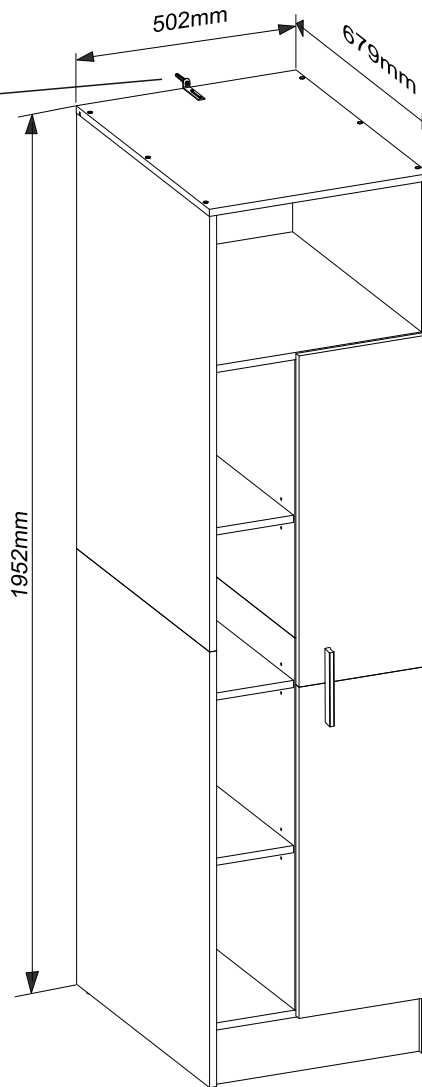
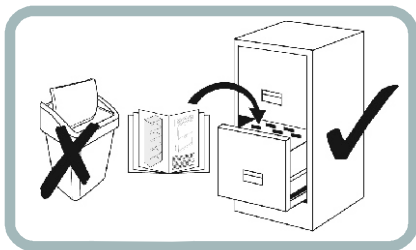
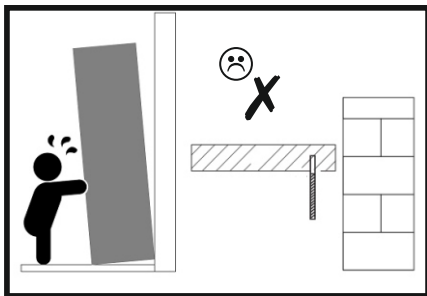
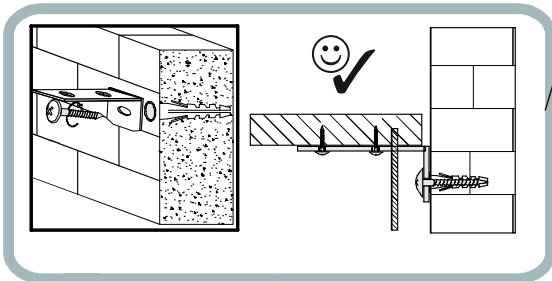
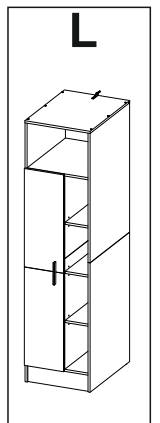
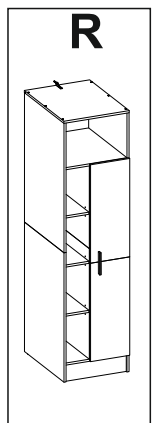
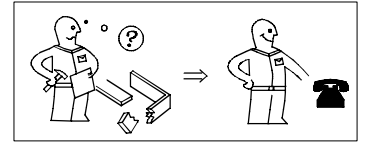
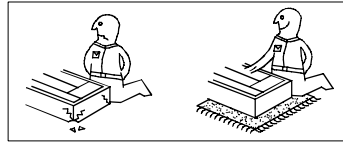
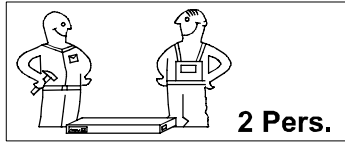
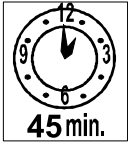

23.03.2026

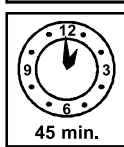
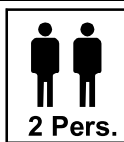
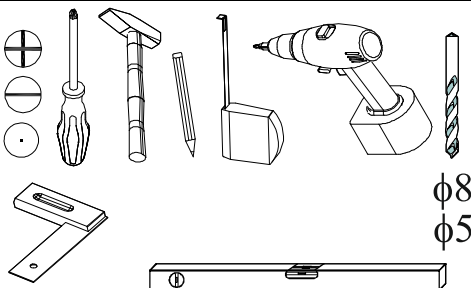

festziehen / tighten / Затягнэне /
 serrer / stringere / utáhnout / vasttrekken /
 zategnuti / strángere / zwiázac / zaciásnac /
 szorosan meghúzni / pevne dotiahnut' /
 trdno pritegniti / затянуть / dra ít



eindrücken / press in / enfoncer / wcisnać
 ribattere / zatlačit / Вкарайте / indrukken
 benyomni / stlačit' / vísiniti / tryck in
 introducere prin apăsare / вдвигать



ausmessen / measure / mesurer /
 misurare / opmelen / izmeriti / miara /
 kiméri / izmeriti / măsurare / измерить
 změřit / Измерете / mät upp / zmierzyc



drücken / press / presser / stisknout /
 Натиснете / vísiniti / nasinac / drukken /
 pritisnuti / nacisnac / pritisniti / нажать /
 (meg)nyomni / apăsare / tryck fast / nacisnac



einschlagen / hammer in / bevern / sla in
 frapper au marteau / infossare / Zabit' /
 zarazit / Набийте / zabiti / wbić
 introducere prin bătaie / забить / zatloct



Drehen - wenden / przekrećić - odwrócić /
 Keren - omdraaien / Girare - Ruotare /
 Okrenuti - ubrnuti / Retourner - renverser /
 Turn over - turn around / Otočte - obratite /
 Завъртете - обърнете / Obrnite list /
 Întoarceți - rotiți / Vrid runt - vänd /
 прокрутить - повернуть / otočit - obrátit
 elforgatni - megfordítani

LKZ 85020

Modellnummer / Number / Numéro du modèle
Numero / Номер на модела / modello
Číslo modelu / Modell száma / Eíslo modelu
Številka modela / Număr model / Broj modela
Modelnummer / Numer modelu

X5W ## 715

Type / Tipo / Típus / Typ / Тип / Tip

715

D Unser Direktservice für Beschlagteile
Sollte Ihnen ein Beschlagteil fehlen, können Sie diese Servicekarte direkt an die untenstehende Adresse mailen. Wir können allerdings nur Beschlagteile auf diesem Wege verschicken. Sollten Sie eine andere Beanstandung an Ihrem Möbelstück haben, so wenden Sie sich bitte direkt an Ihr Möbelhaus.

GB Our direct order service for fitting
If a fitting part is missing, you can e-mail this service card directly to the address below. However, we can only send fitting parts in this way. If you have any other cause for complaint concerning your item of furniture, please contact your furniture store directly.

CZ Naše primé služby pro kování
Chybí-li vám nějaký díl z kování, můžete tuto servisní kartu odeslat e-mailem přímo na níže uvedenou adresu. Touto cestou však můžeme zoslat jen díly kování. Pokud byste reklamovali jiný díl nábytku, obraťte se přímo na svého prodejce nábytku.

F Bien etudier la notice de montage
S'il vous manque une ferrure, veuillez envoyer directement la présente carte service à l'adresse e-mail indiquée ci-dessous. Cependant, ceci nous permet uniquement d'envoyer des ferrures. Pour tout autre type de réclamation concernant votre meuble, veuillez contacter directement votre magasin d'ameublement.

I Il nostro servizio diretto per l'ordine della ferramenta
Qualora Vi dovesse mancare un pezzo di fissaggio, allora Vi preghiamo di inviare questa carta di servizio immediatamente all'indirizzo sottostante. Possiamo inviare i pezzi di fissaggio solamente per mezzo di questo procedimento. Qualora dovete avere qualche altra reclamazione in merito al mobile, allora Vi preghiamo di rivolgerVi direttamente al Vostro Negozio di mobili.

BG Нашата директна услуга за обкоя
Ако липсаат части от комплекта, попълнете настоящата сервисна карта и ни я изпратете на e-mail адреса, посочен по-долу. По този начин можем да доставяме само липсващи елементи от обкоя. Ако установите други дефекти по мебелите, Ви съветваме да се обърнете към мебелната къща/магазин, от който сте закупили стоката.

NL Onze directservice voor losse onderdelen
Wanneer er een onderdeel ontbreekt, kunt u deze servicekaart direct aan onderstaand e-mailadres sturen. Wij kunnen langs deze weg echter alleen beslagdelen versturen. Mocht u een ander probleem aan uw meubel hebben, verzoeken wij u contact op te nemen met uw meubeldealer.

PL Nasz bezpośredni serwis części montazowych
Jeżeli brakuje części koniecznych do montażu, prosimy o przesłanie nam niniejszej karty serwisowej na niżej podany adres e-mailowy. W ten sposób możemy przesłać Państwu tylko brakujące części. W przypadku innych reklamacji dotyczących mebla, prosimy zgłosić się do salonu meblowego, w którym został dokonany zakup.

HR Servis za okove
U slučaju da nedostaje neki od dijelova molimo vas da na dolje navedenu mail adresu pošaljete ovaj servisni obrazac. Na ovaj način mogu se dostaviti samo okovi. U slučaju da imate dodatne prigovore vezane uz komad namještaja molimo vas da se obratite izravno trgovini namještaja gdje je isti kupljen.

HU Direktszolgáltatunk vasalattok esetén
Ha hiányzik egy vasalat, ezt a kártyát közvetlenül elküldheti az alább található címre. Azonban csakis vasalatokat tudunk így küldeni. Amennyiben másfajta reklamáció áll fenn bitordarabját illetően, forduljon közvetlenül a bitorházhöz.

SK Náš priamy servis pre časti kovania
Ak by Vám chýbala nejaká časť kovania, môžete poslať túto servisnú kartu pošťou na nižšie uvedenú adresu. Diely kovania vieme poslať iba týmto spôsobom. Ak by ste mali inú reklamáciu ohľadom Vášho nábytku, obráťte sa priamo na Vašu predajňu nábytku.

SLO Naše direktne uslužne storitve za okovje
Če vam manjka kakšno okovje, lahko to servisno kartico pošljete po e-pošti direktno na spodnji naslov. Po tej poti vam lahko pošljemo samo okovje. Če želite reklamirati kakšen drug del pohištva, se obrnite neposredno na vašo trgovino pohištva.

RO Service-ul nostru direct pentru feronerie
In cazul în care vă lipseşte o piesă de feronerie puteţi să trimiteţi direct acest card de service prin e-mail la adresa de mai jos. Noi nu putem expedia piese de feronerie decât pe această cale. Dacă aveţi o altă reclamaţie referitoare la piesa de mobilier, atunci vă rugăm să vă adresaţi direct la magazinul dvs. de mobilă.

RUS Наш прямой сервис для поставок фурнитуры
Если окажется, что Вам не хватает того или иного элемента фурнитуры, Вы можете отправить сервисную карту по факсу непосредственно на нижеприведенный адрес электронной почты. Однако, таким образом мы можем пересылать лишь фурнитуру. Если же у Вас возникнут иные претензии относительно приобретенной мебели, пожалуйста, обращайтесь непосредственно в организацию, осуществившую продажу.

S Vår direktservice för beslagsdelar
Om du saknar en beslagsdel kan du skicka detta servicekort direkt till e-postadressen som anges nedan. Tänk på att detta är den enda möjligheten att skicka beslagsdelar till dig. Om du vill reklamera din möbel av en annan anledning måste du kontakta ditt möbelhus direkt.

ES Nuestro servicio directo para accesorios
Si le falta algún accesorio, puede enviar esta tarjeta de servicio directamente a la siguiente dirección. No obstante, por este método solo podemos enviar accesorios. Si tiene alguna otra objeción sobre su mueble, consulte directamente con su mueblería.

TR Donatılar için doğrudan servisimiz
Bir donatınız eksikse bu servis kartını doğrudan aşağıda bulunan adrese doğrudan mail yazabilirsiniz. Sadece bu yolla donatılar gönderilebilir. Mobilyanızda başka şikayetleriniz varsa lütfen doğrudan mobilya satıcınıza danışın.

max.



Nr	Maße mm	Colli	Anzahl
1	968 663 16	2/3	1
2	968 663 16	2/3	1
3	968 663 16	3/3	1
4	968 663 16	3/3	1
5	502 664 16	3/3	1
6	468 642 16	1/3	1
7	618 642 16	1/3	1
8	827 642 16	1/3	1
9	178 637 16	1/3	3
10	468 125 16	1/3	1
11	468 642 16	1/3	1
12	736 301 16	2/3	1
13	736 301 16	2/3	1
14	907.5 482 3	2/3	2
15	482 5	1/3	1
16	270 22 14	1/3	1
B*		1/3	1

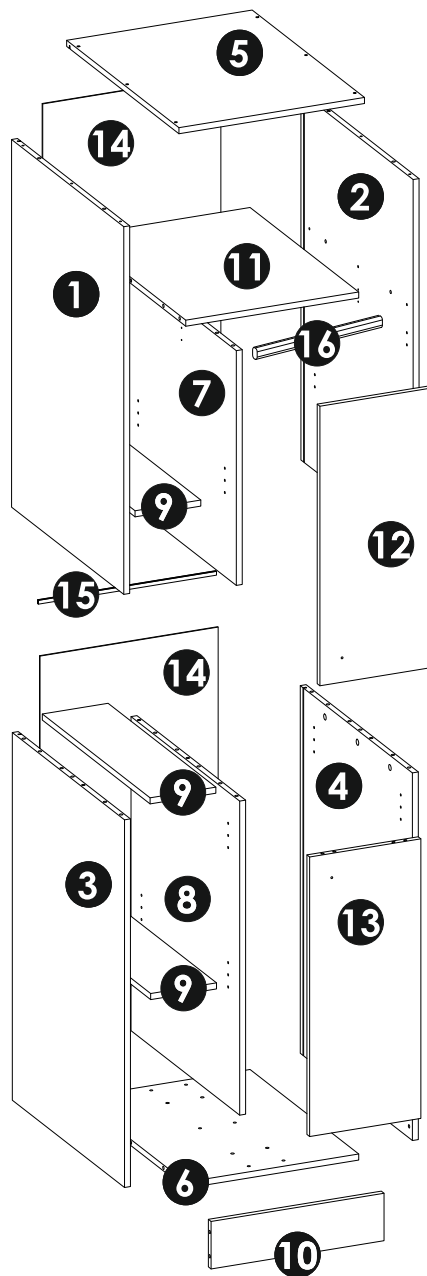

Grund der Beanstandung / Reason of the objection:

Möbelhaus / Furniture store:

Name / Nom: Telefon / Telephone:

PLZ / Bank sorting code: Ort / City:

Strasse / Street:

Haus-Nr. / House No.: @E-Mail:

LKZ 85020

Modellnummer / Number / Numéro du modele
Numero / Номер на модела / modello
Číslo modelu / Modell száma / Eíslo modelu
Številka modela / Număr model / Broj modela
Modelnummer / Numer modelu

X5W ## 715

Туре / Типо / Típus / Түр / Тип / Tip

715

B1

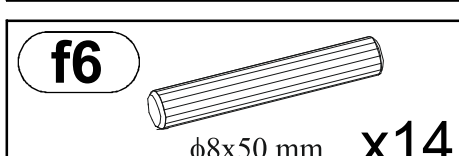
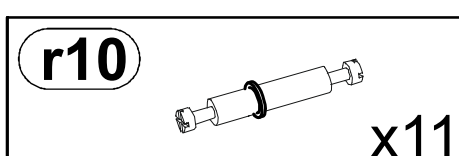
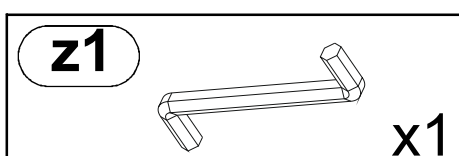
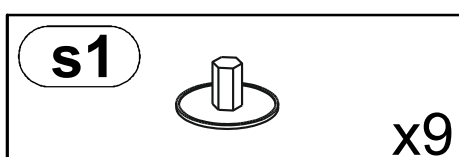
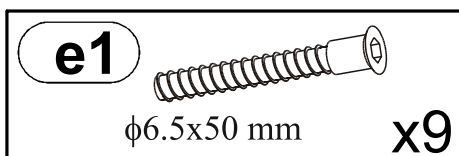
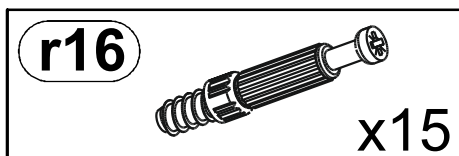
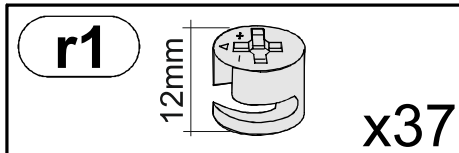
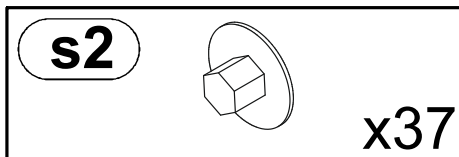
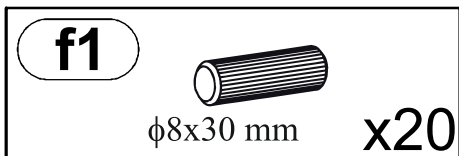

B2

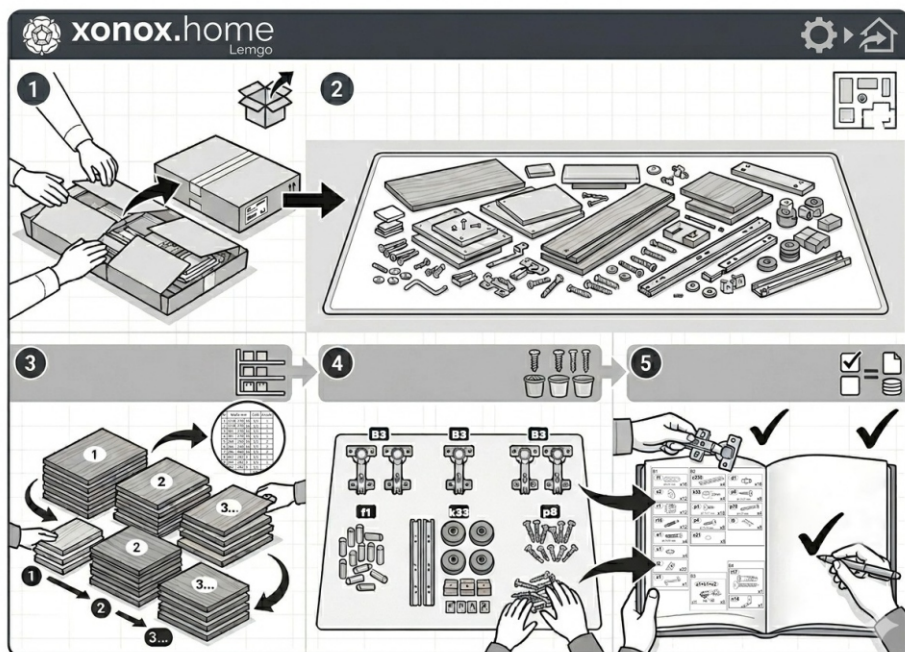
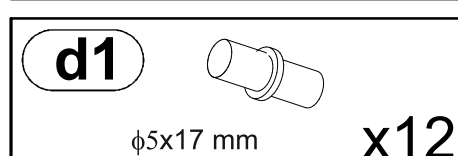
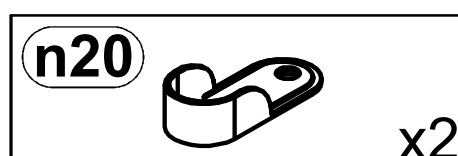
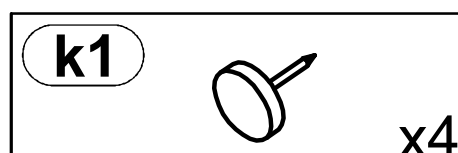
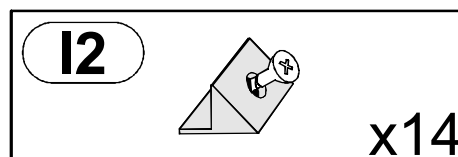
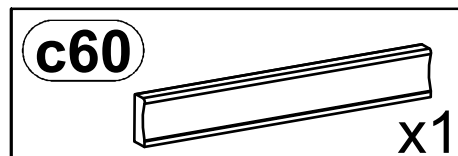
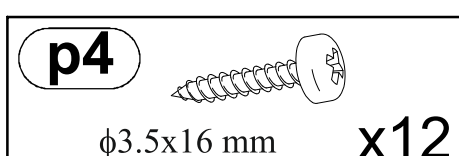
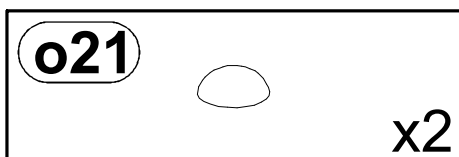
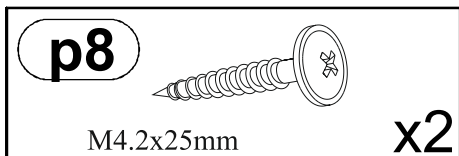

LKZ 85020

Modellnummer / Number / Numéro du modele
Numero / Номер на модела / modello
Číslo modelu / Modell száma / Eíslo modelu
Številka modela / Număr model / Broj modela
Modelnummer / Numer modelu

Туре / Тиро / Тípus / Тур / Тип / Тíп

715

X5W ## 715

B3

a1+b1+e2

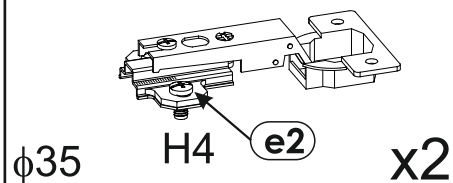

a11

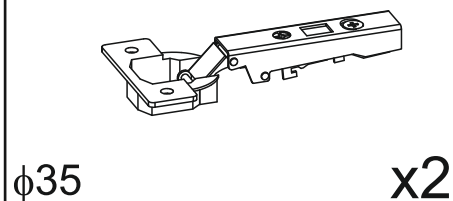

b12+e2

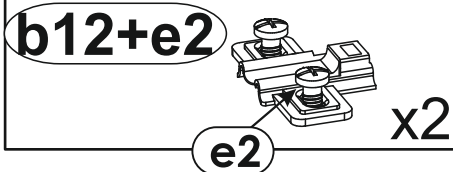

B4

t17

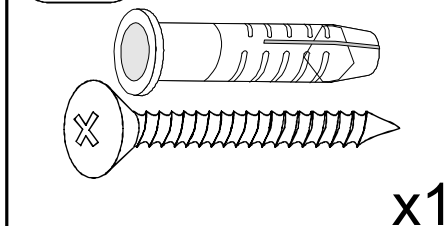

n14

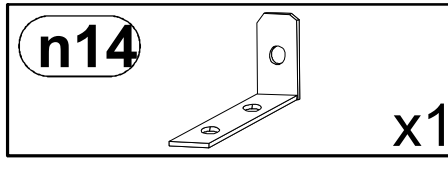

version A



version B

b1

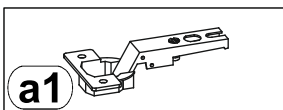
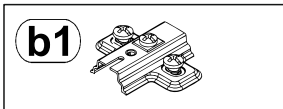

b12

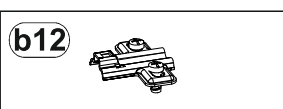

a11

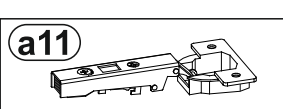

b1 + a1

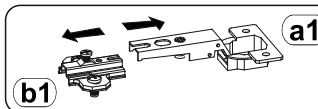
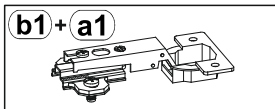

b12 + a11

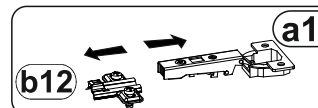
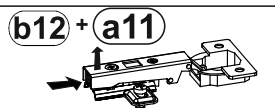

1



φ8x30 mm

x6

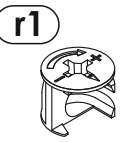

r1

x15



r16

x6

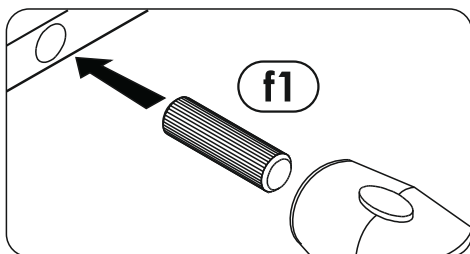
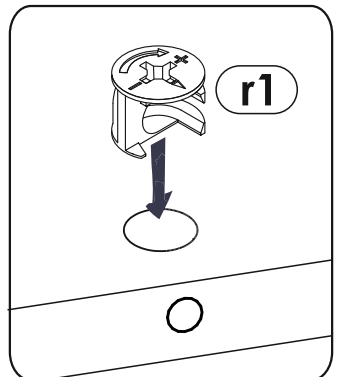
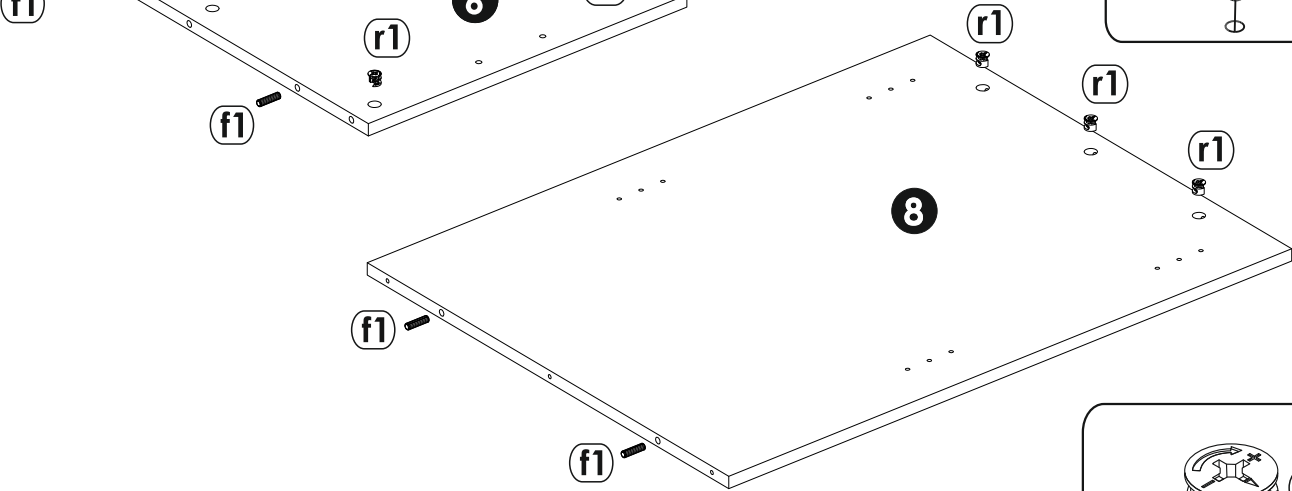
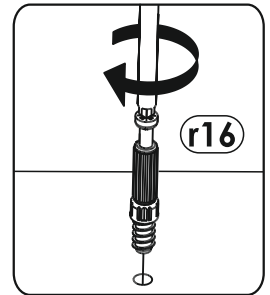
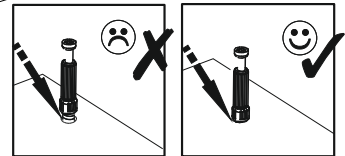
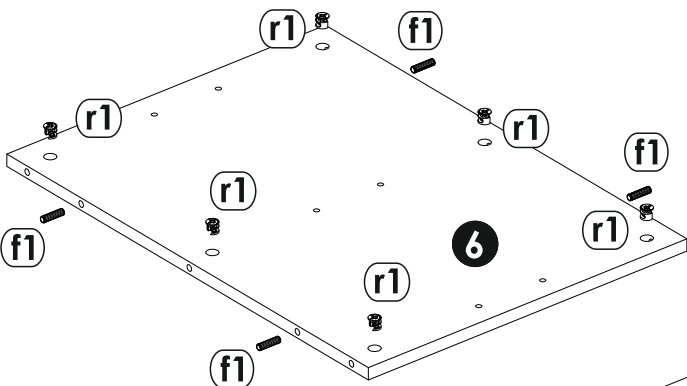
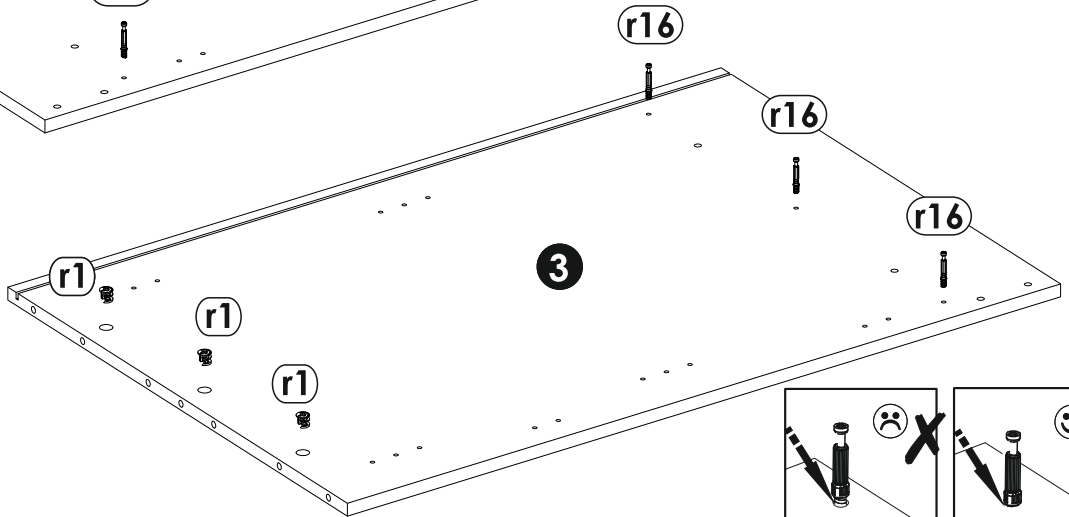
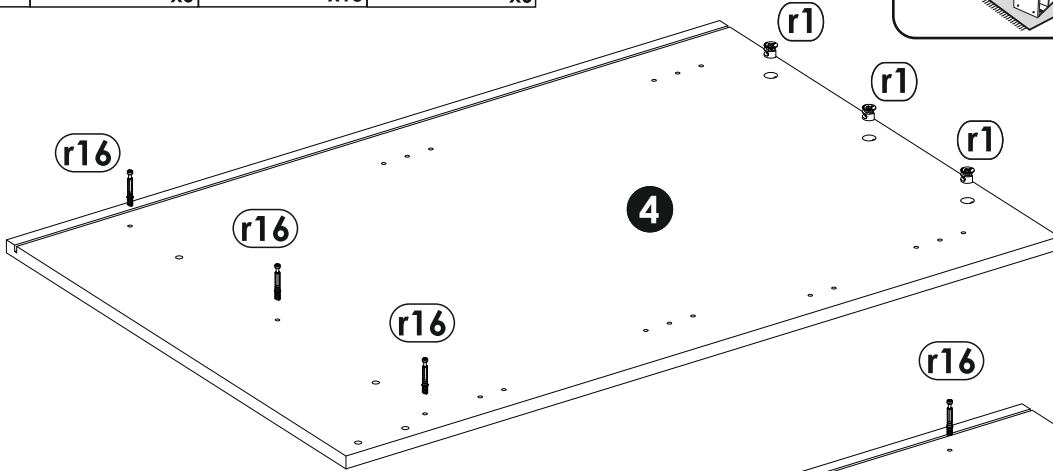
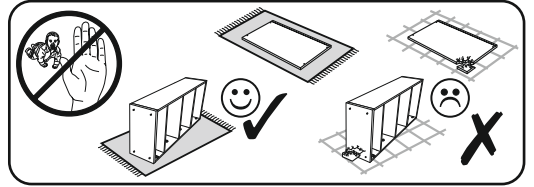

2

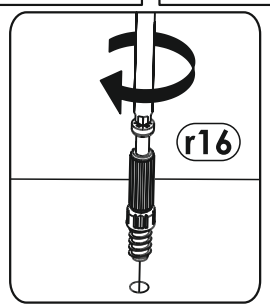
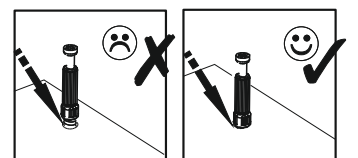
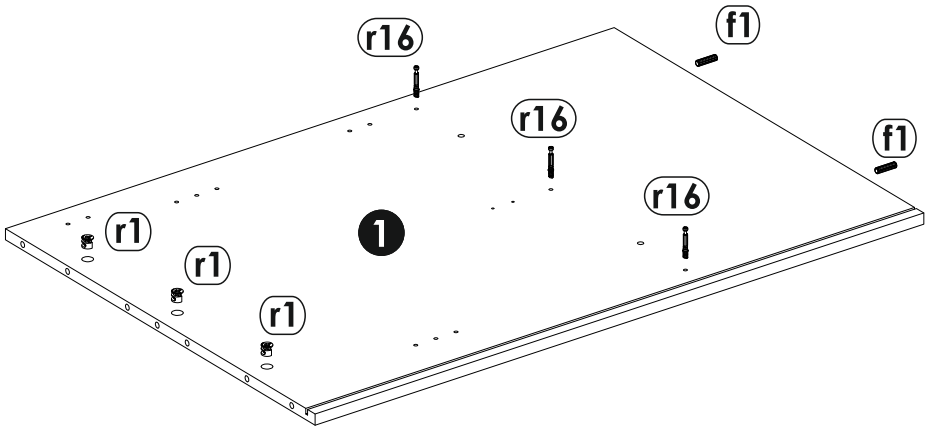
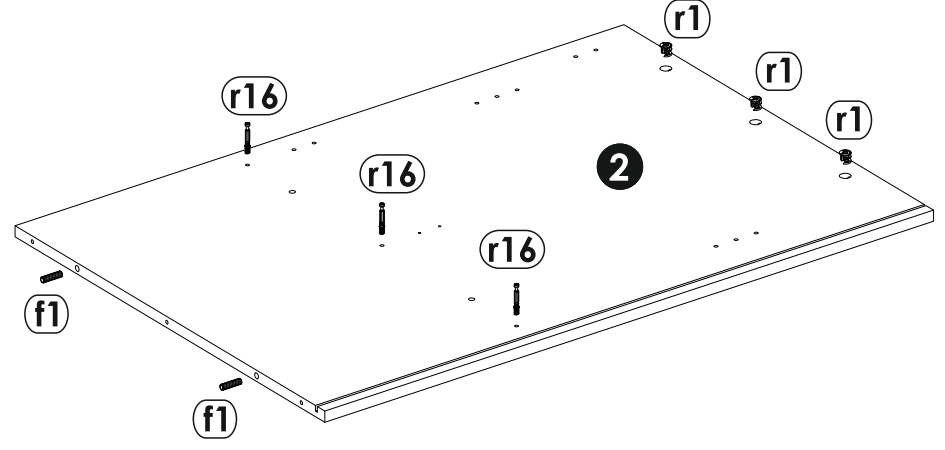
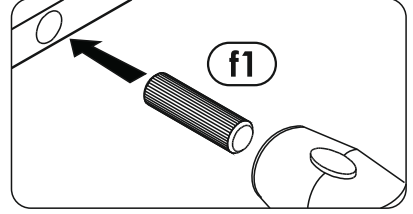
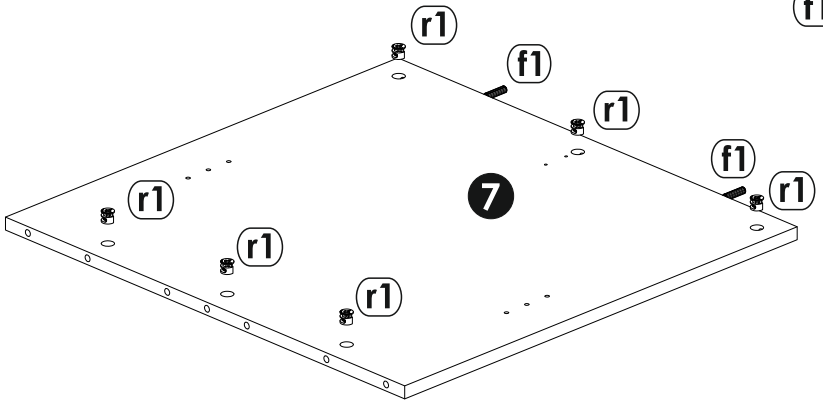
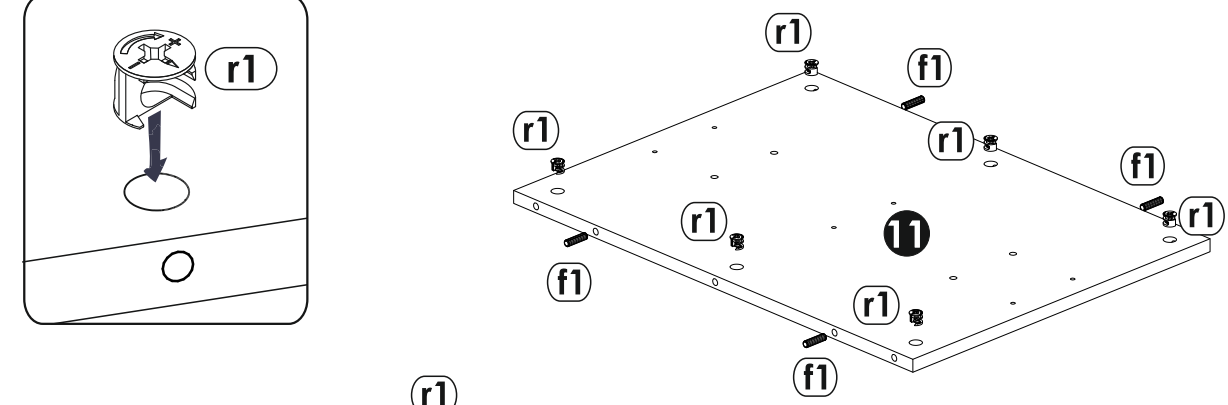
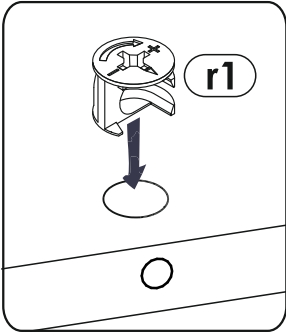
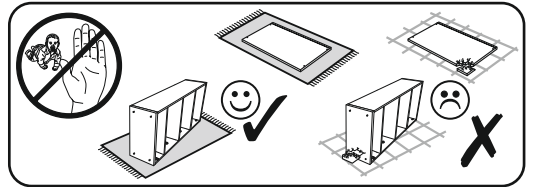
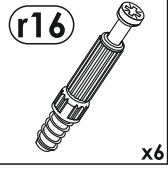
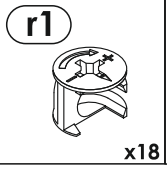
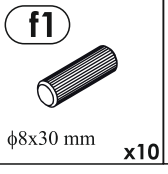

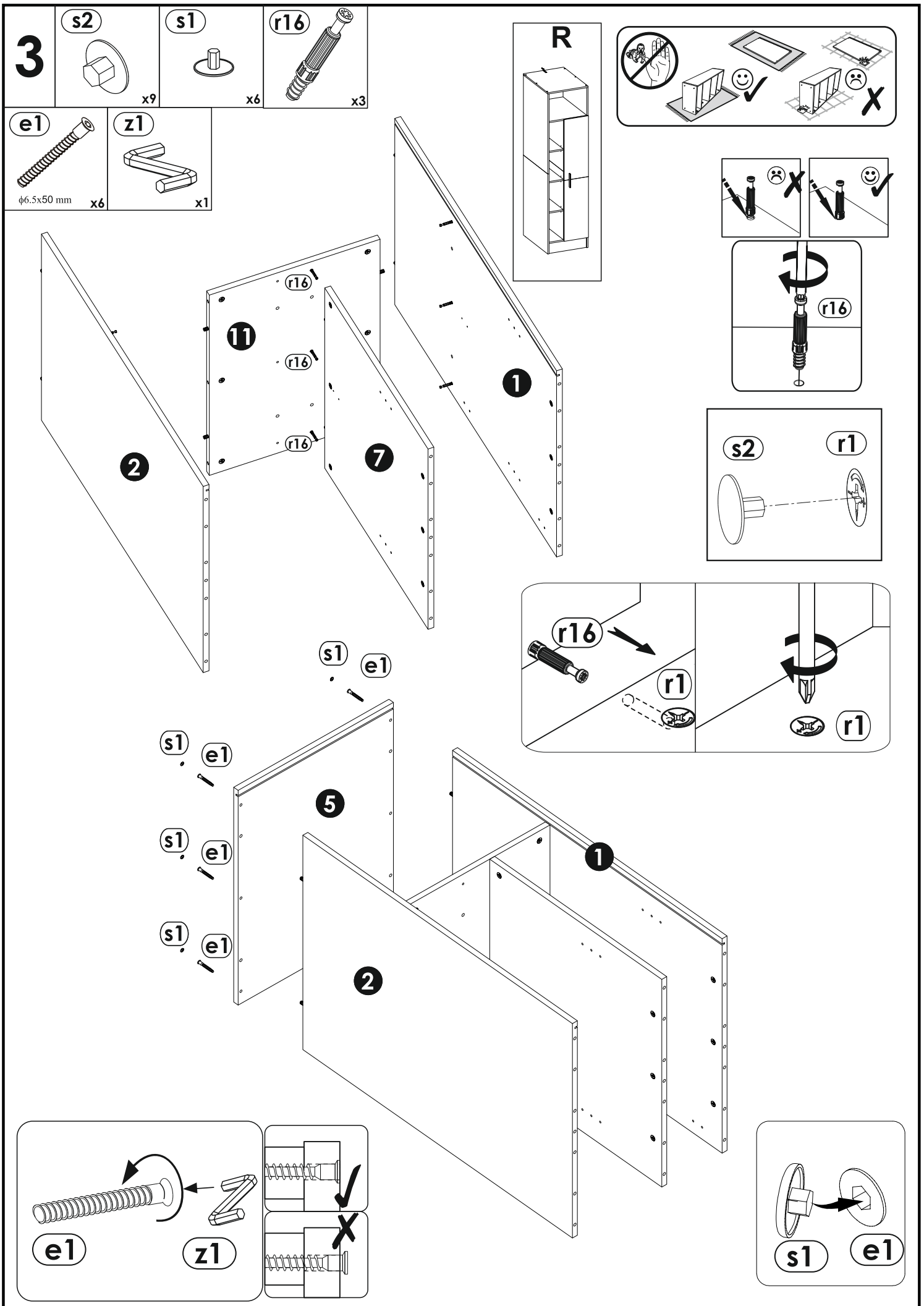

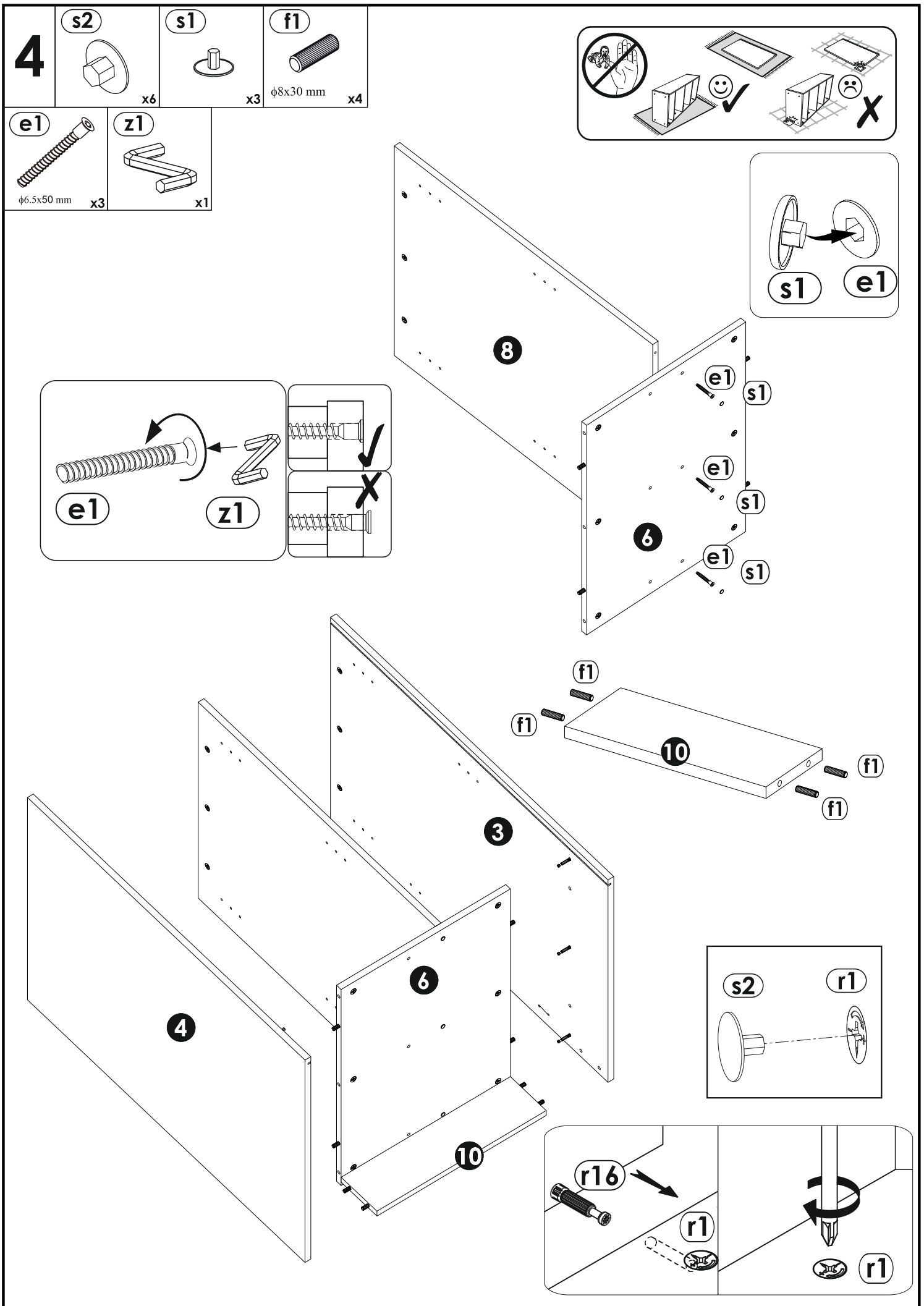

5

r10

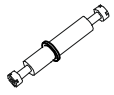

x9

f6

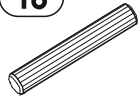

φ8x50 mm

x12

s2



x18

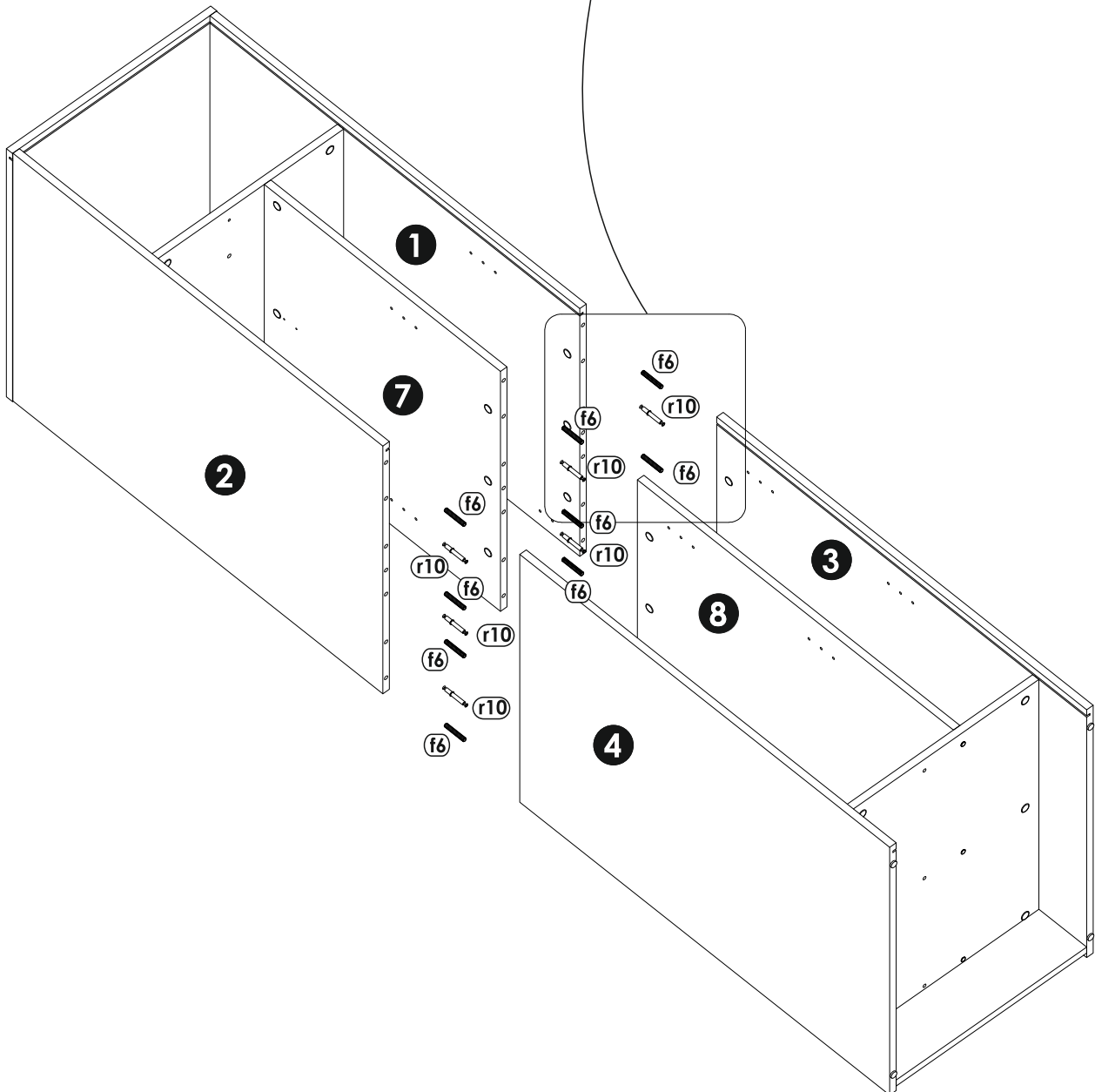
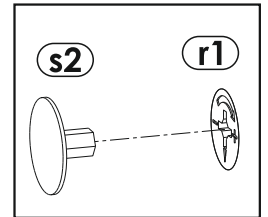
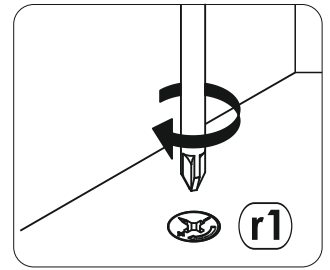
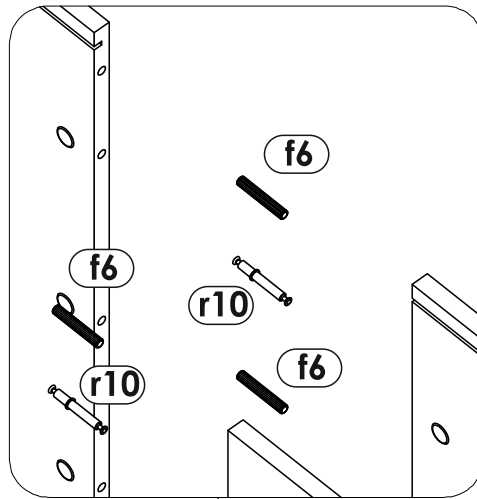
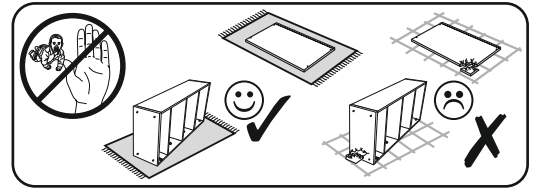

6

I2



x14

p4



φ3.5x16 mm

x12

k1



x4

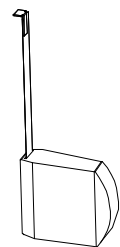
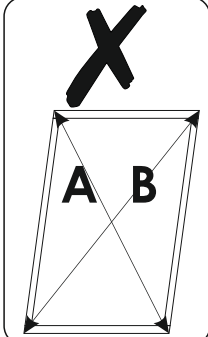
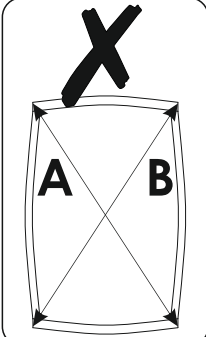
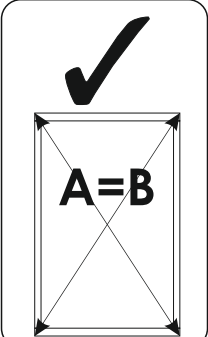
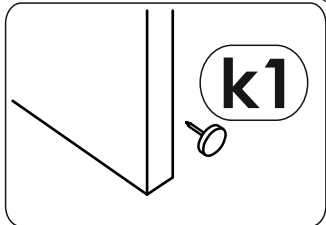
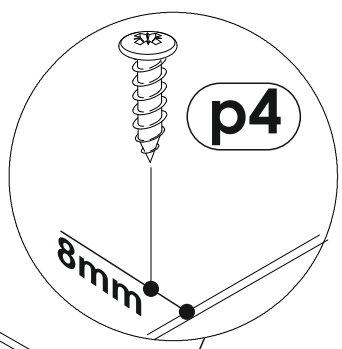
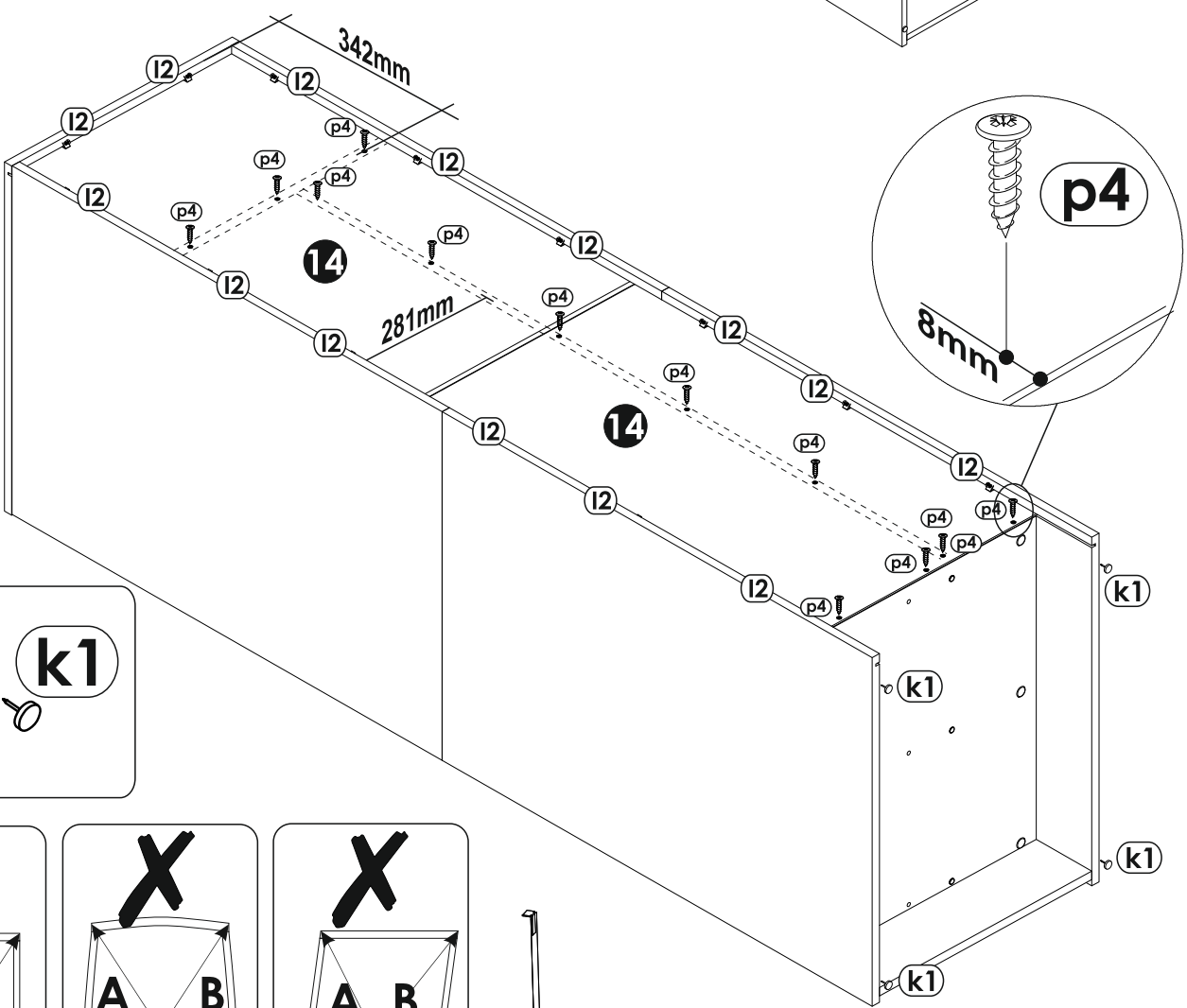
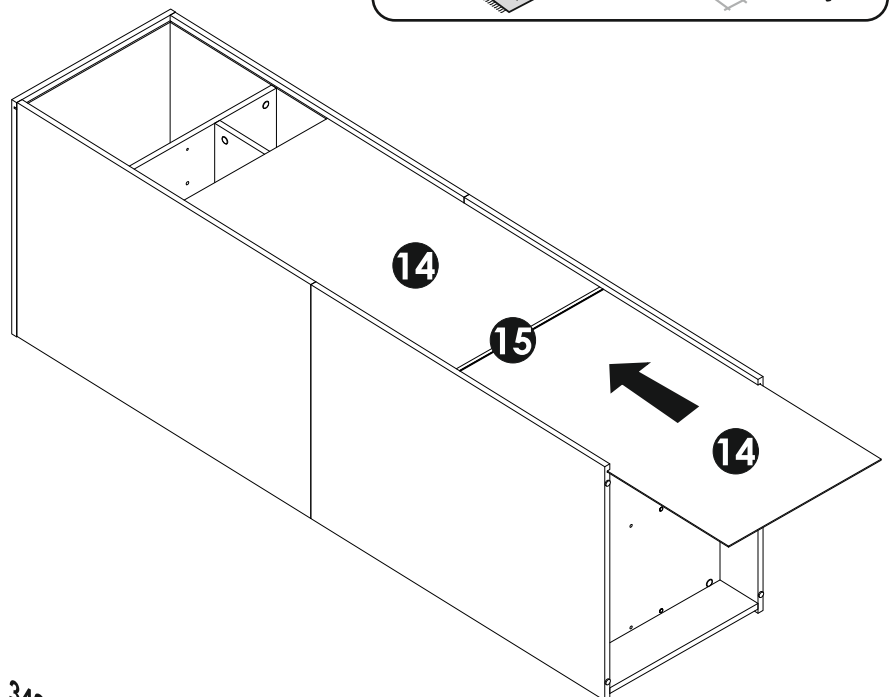
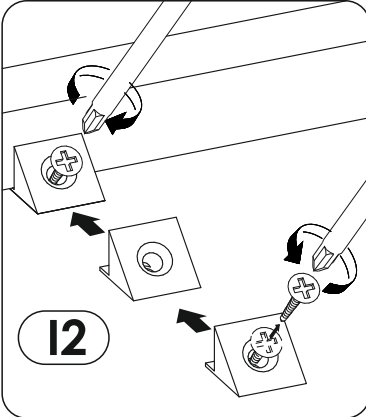
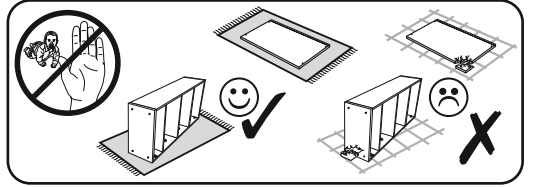

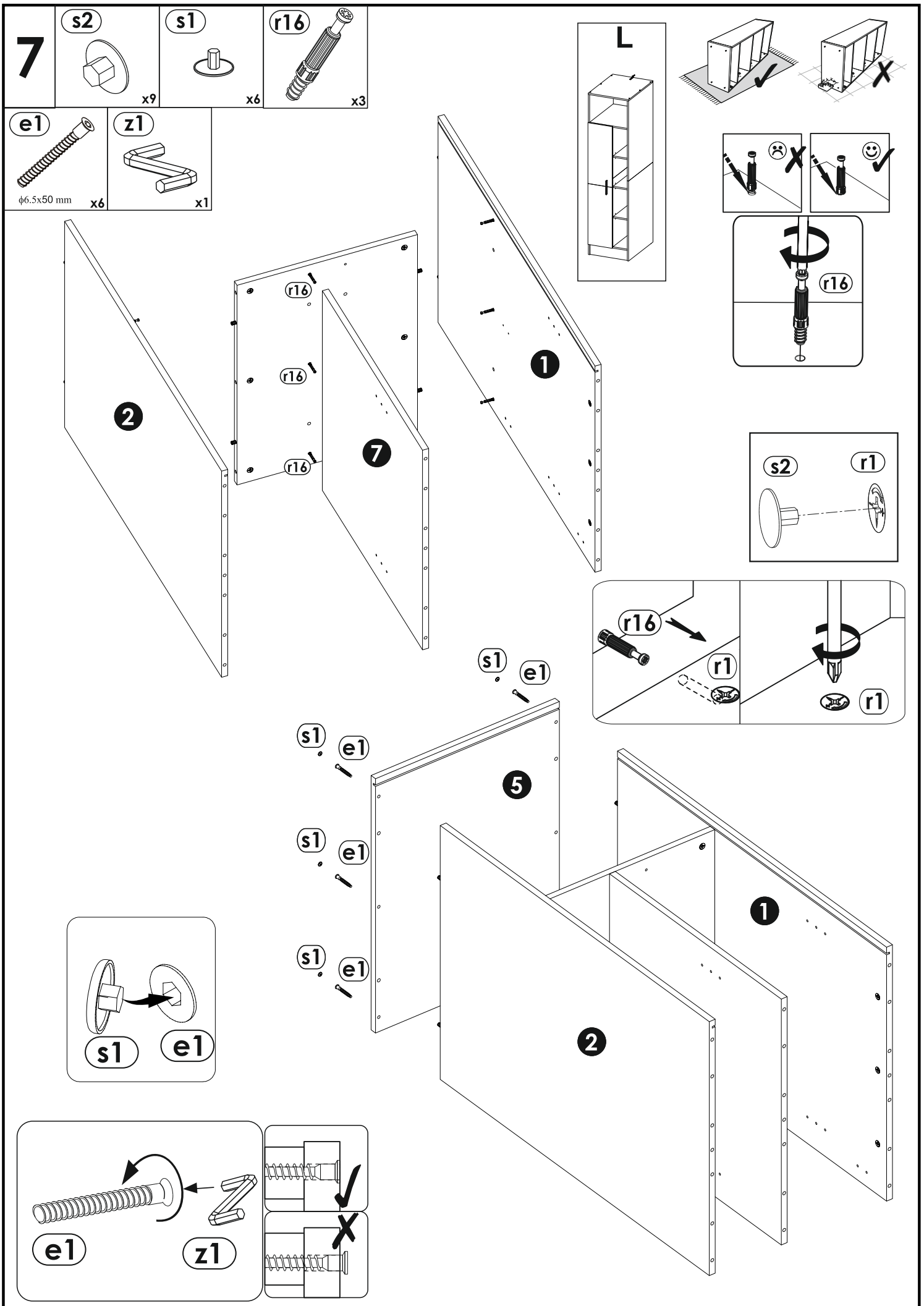

9

r10

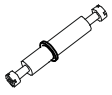

x9

f6

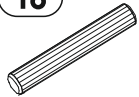

φ8x50 mm

x12

s2



x18

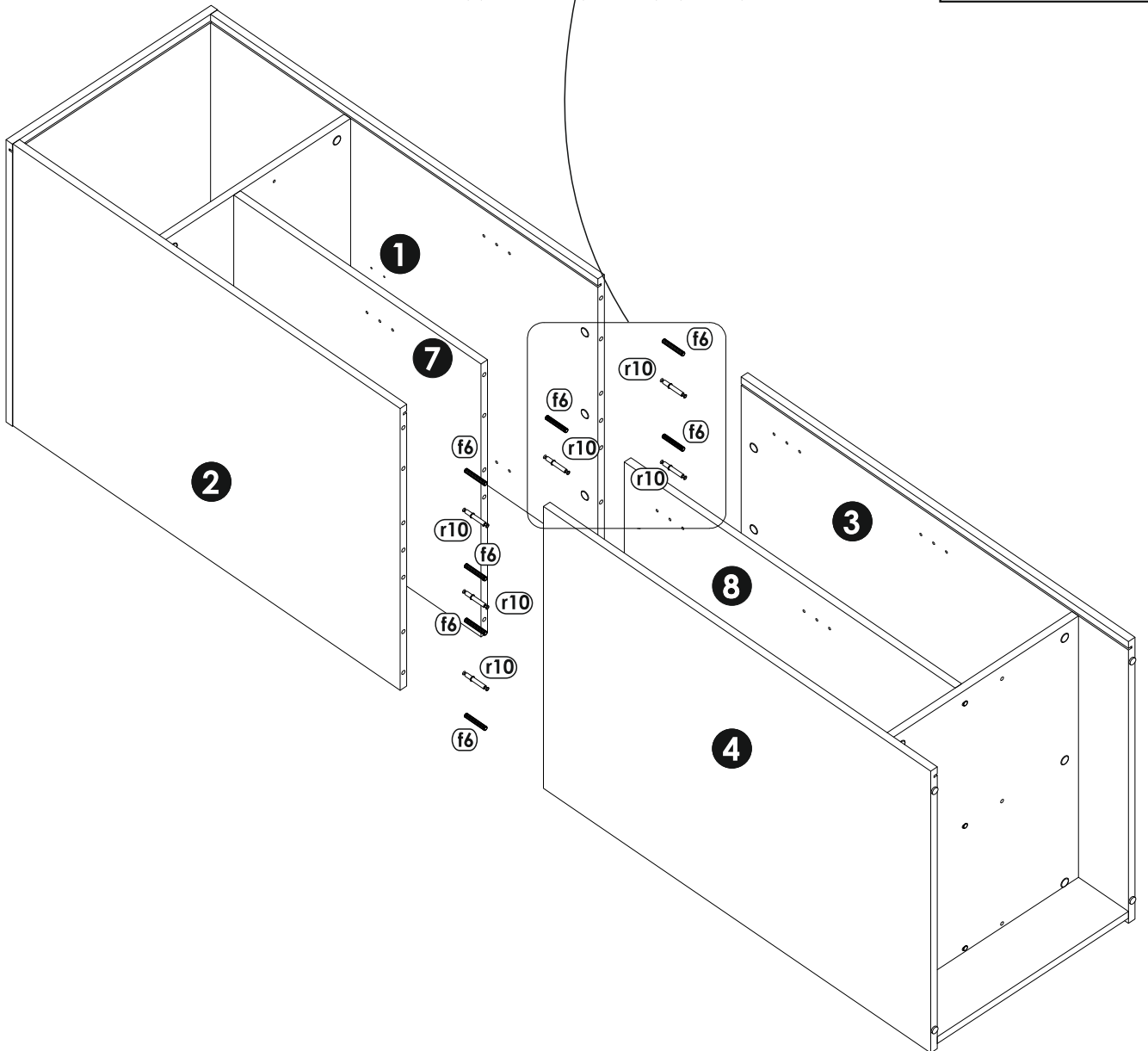
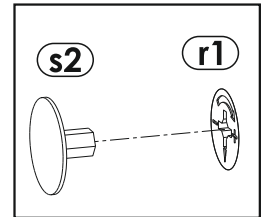
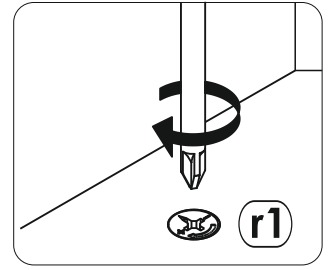
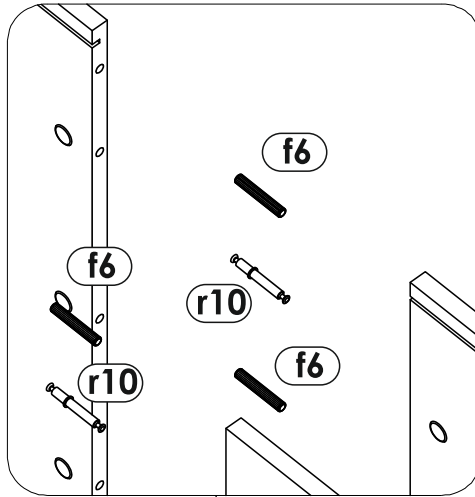
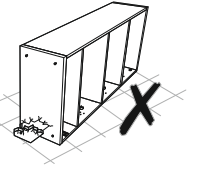
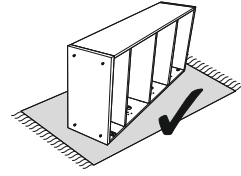

10

I2



x14

p4



φ3.5x16 mm

x12

k1



x4

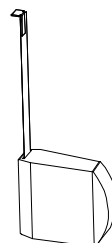
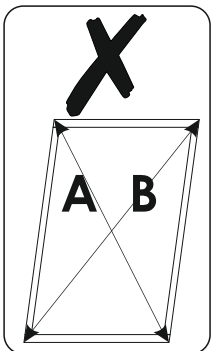
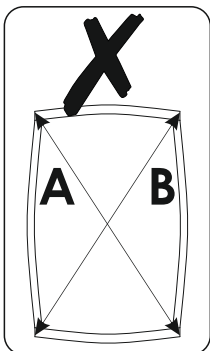
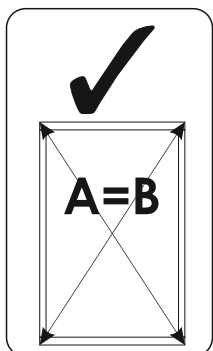
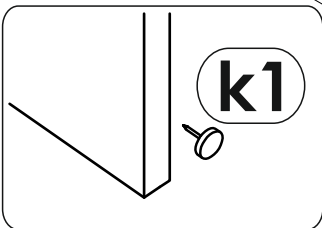
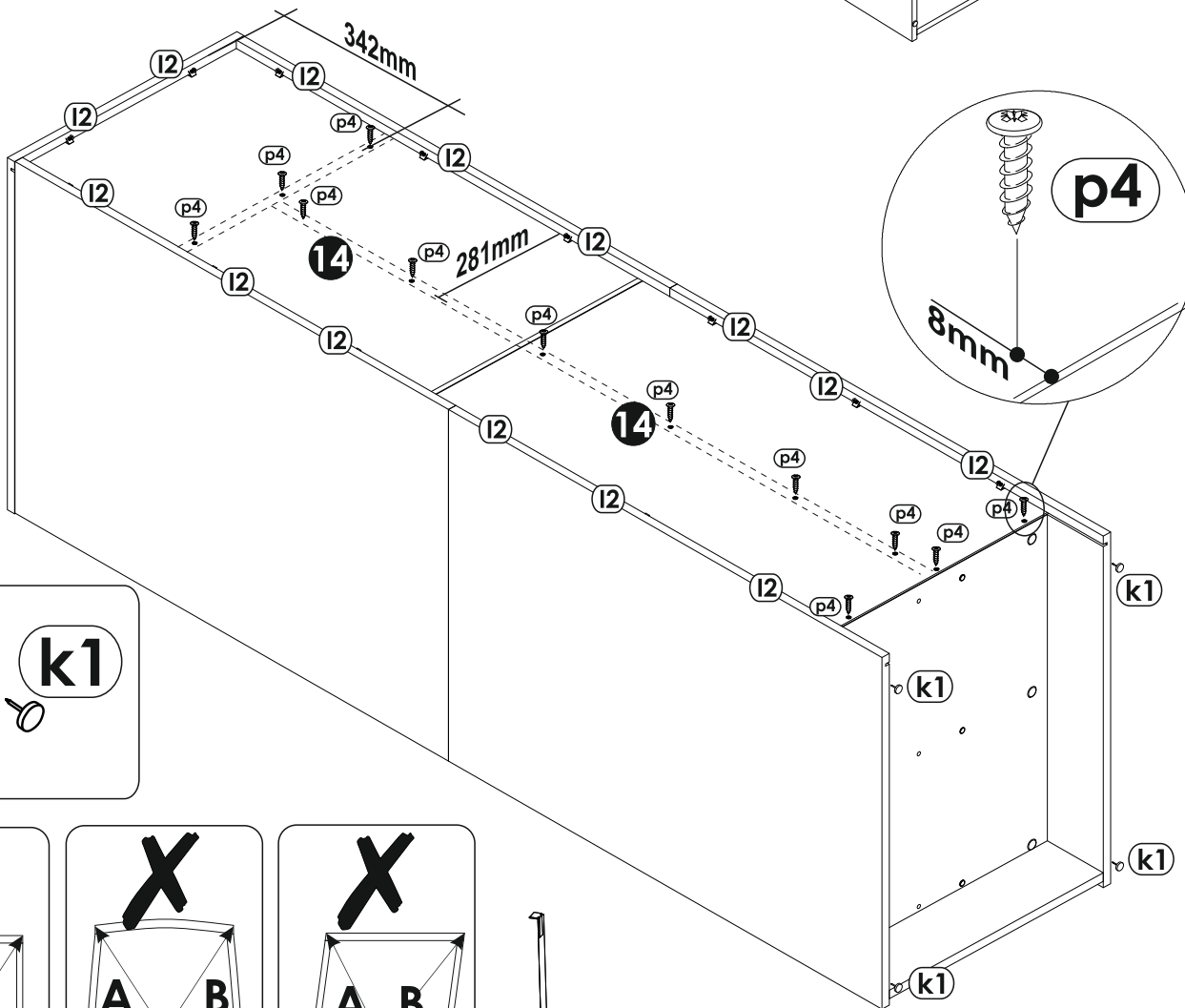
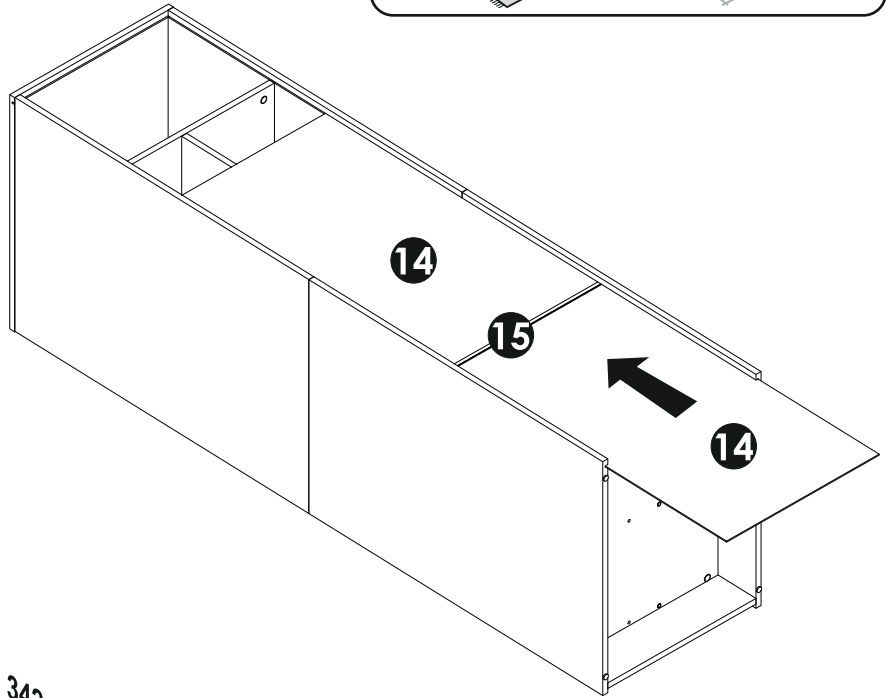
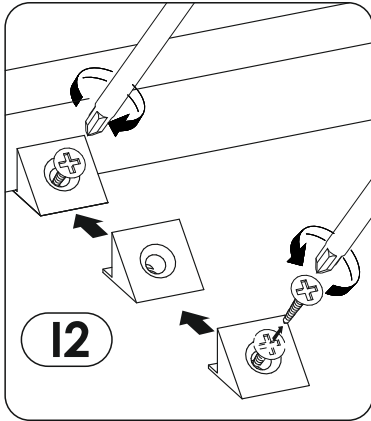
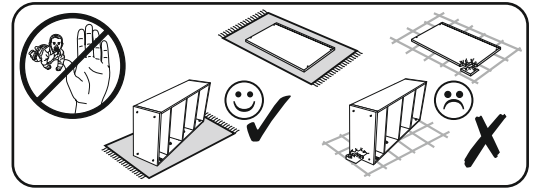

11

p1



φ3.5x13 mm

x8

a1

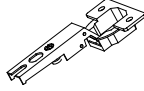

x2

r10

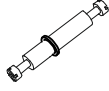

x2

f6

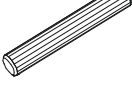

φ8x50 mm

x2

o21



x2

s2



x4

r1



x4

a11

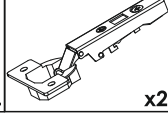

x2

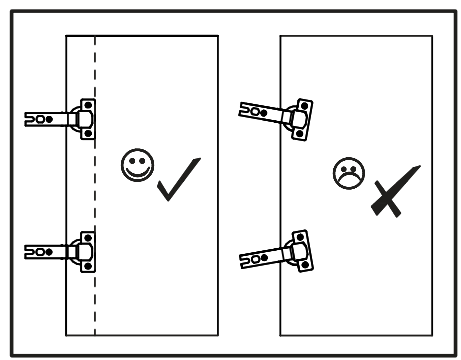
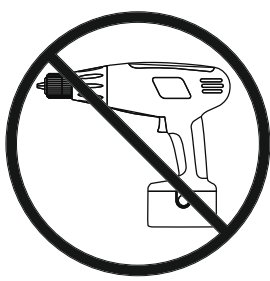
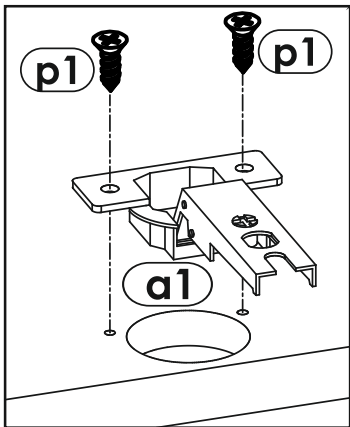
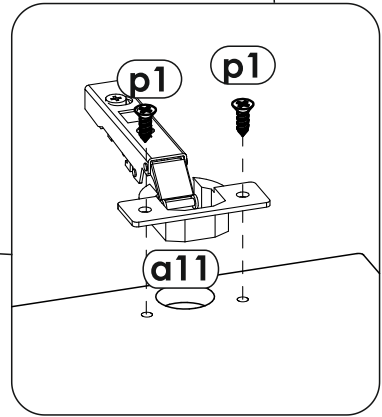
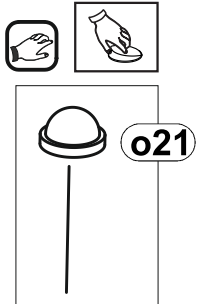
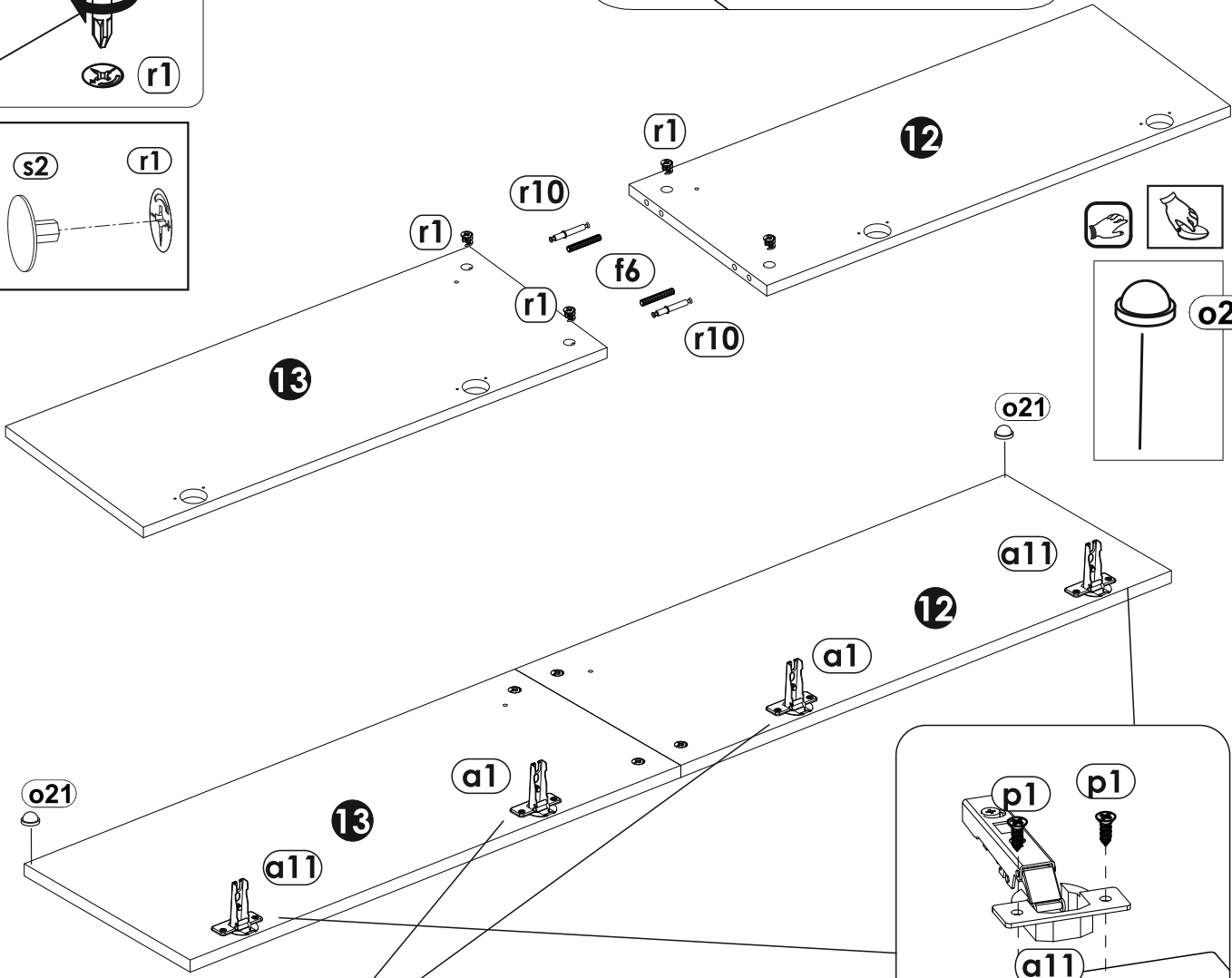
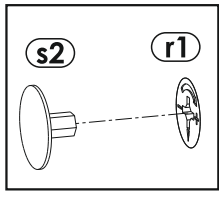
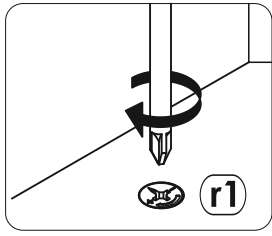
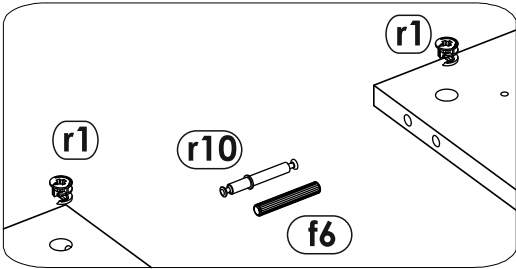
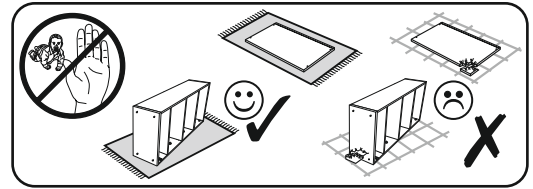

12

d1



φ5x17 mm

x12

p1



φ3.5x13 mm

x2

t17



φ8x50 mm

x1

n14



x1

e2



φ6.3x13 mm

x4

b2

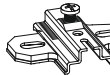

x2

b12+e2

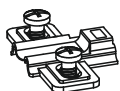

x2

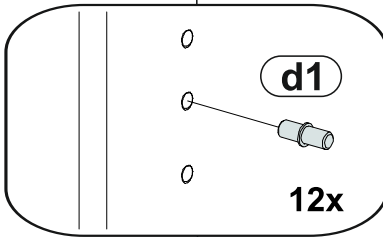
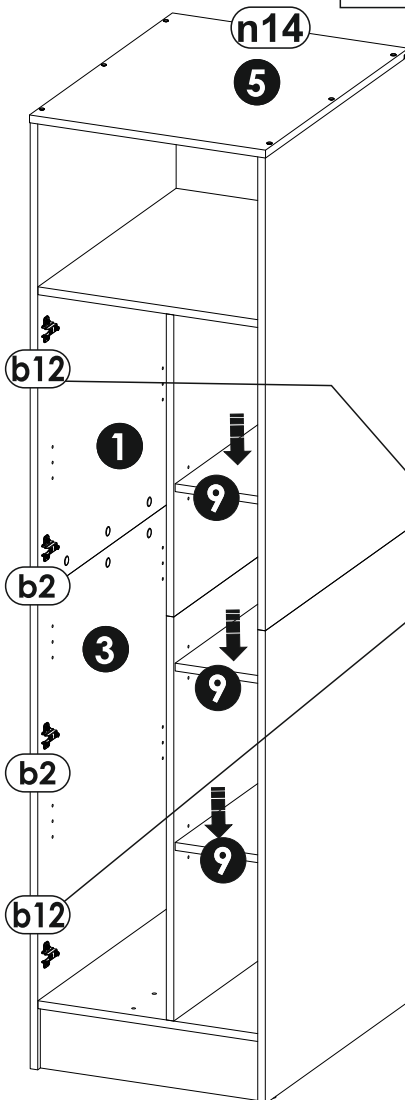
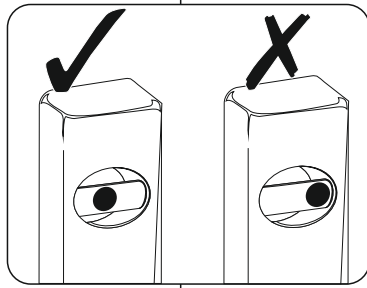
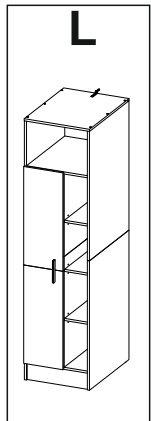
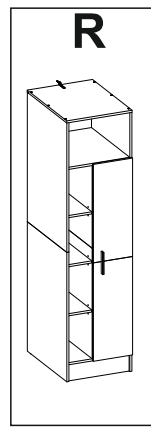
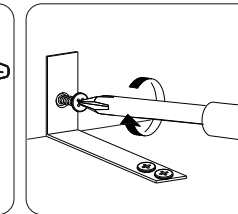
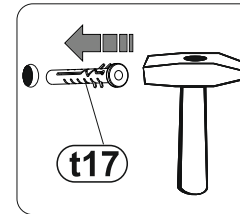
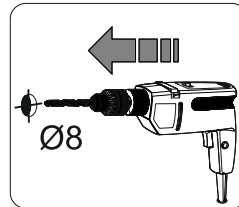
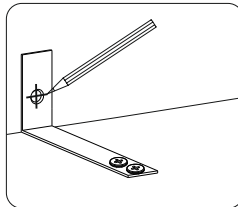
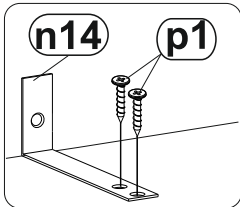
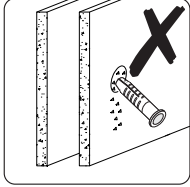
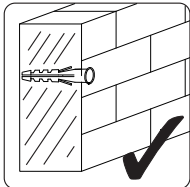

d1

12x

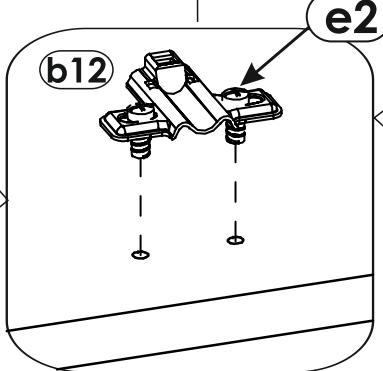

b12

e2

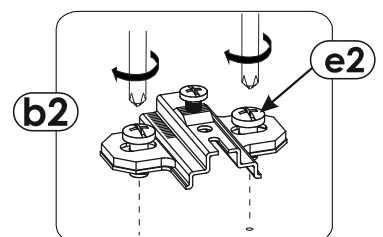

b2

e2

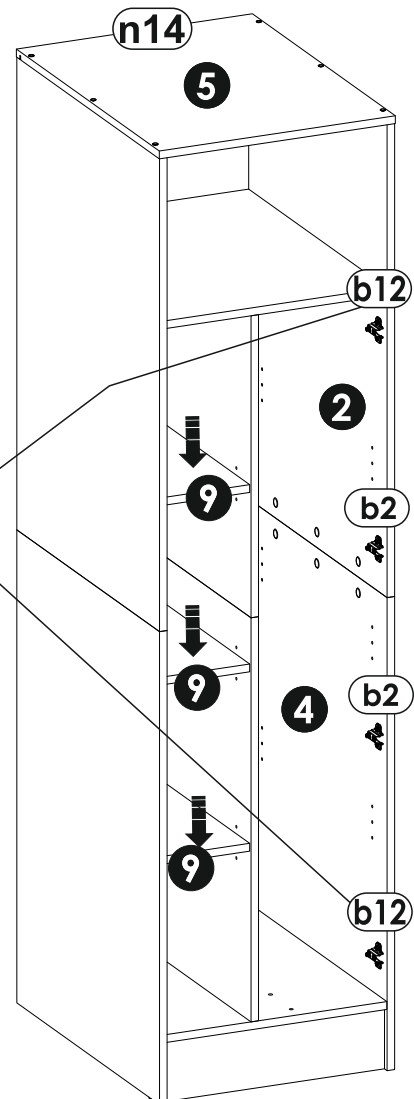

13

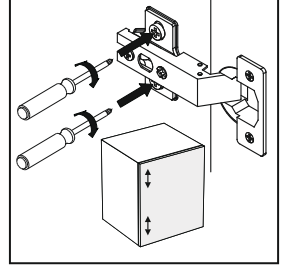
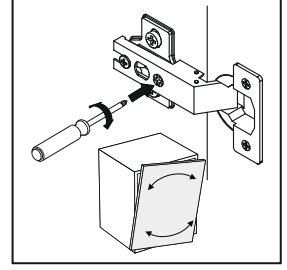
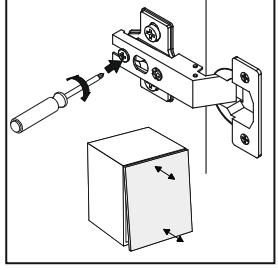
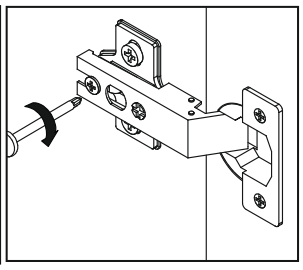
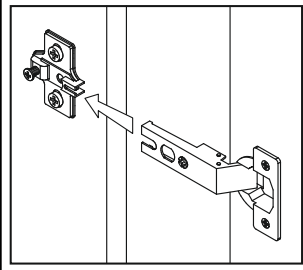
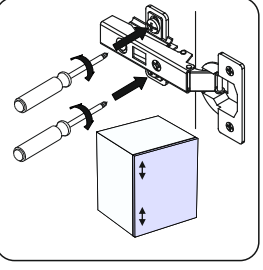
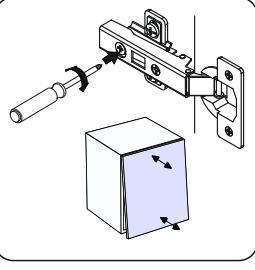
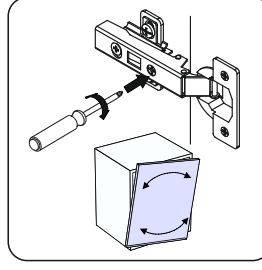
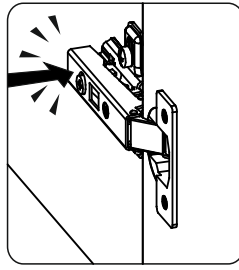
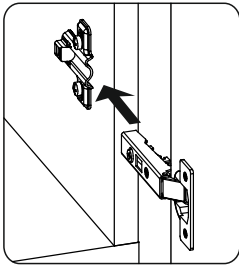
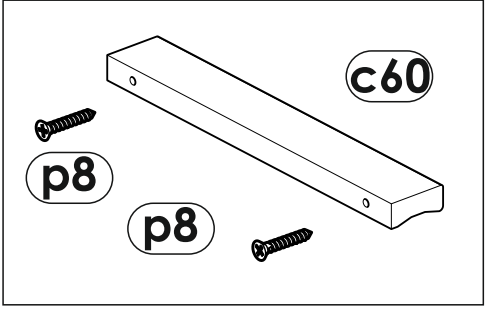
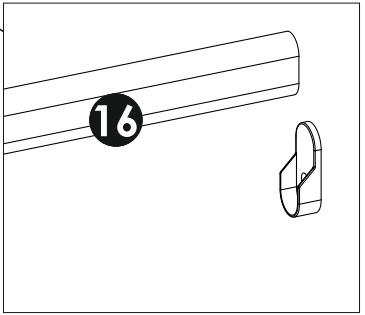
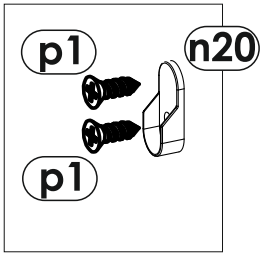
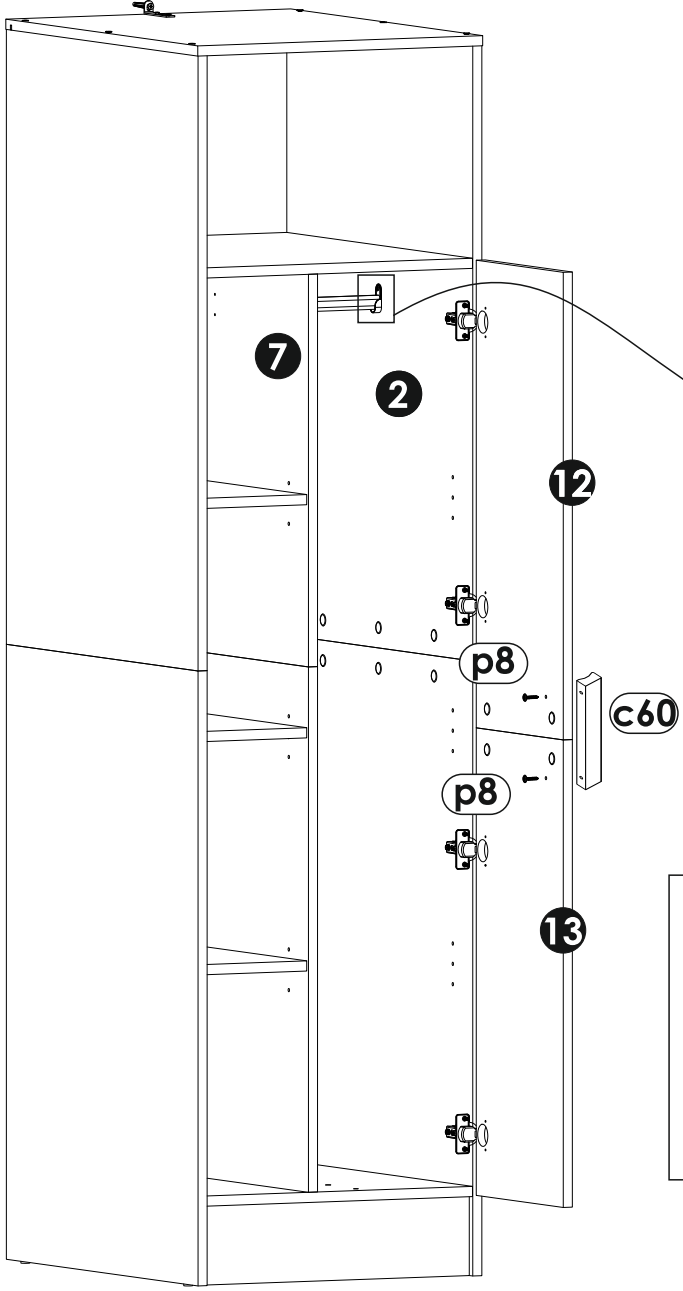
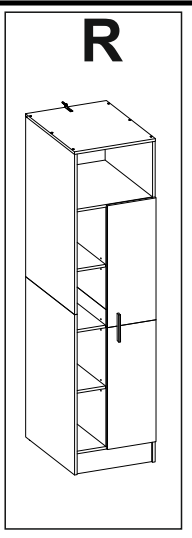
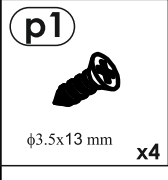
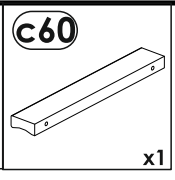
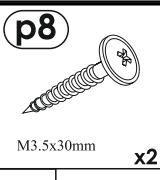

14

