

ASSEMBLY INSTRUCTION-

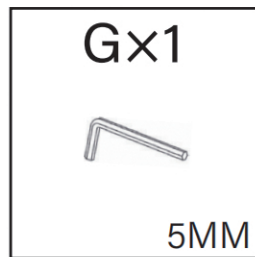

1

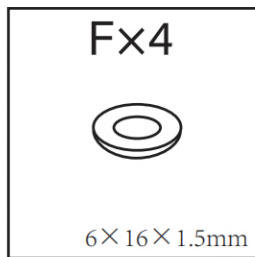
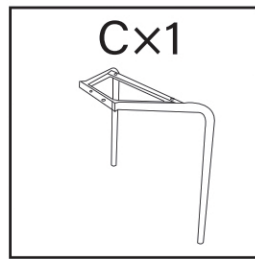
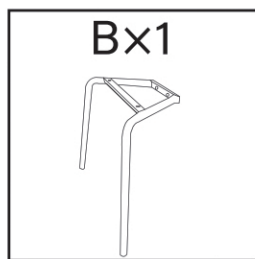
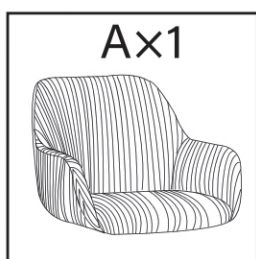
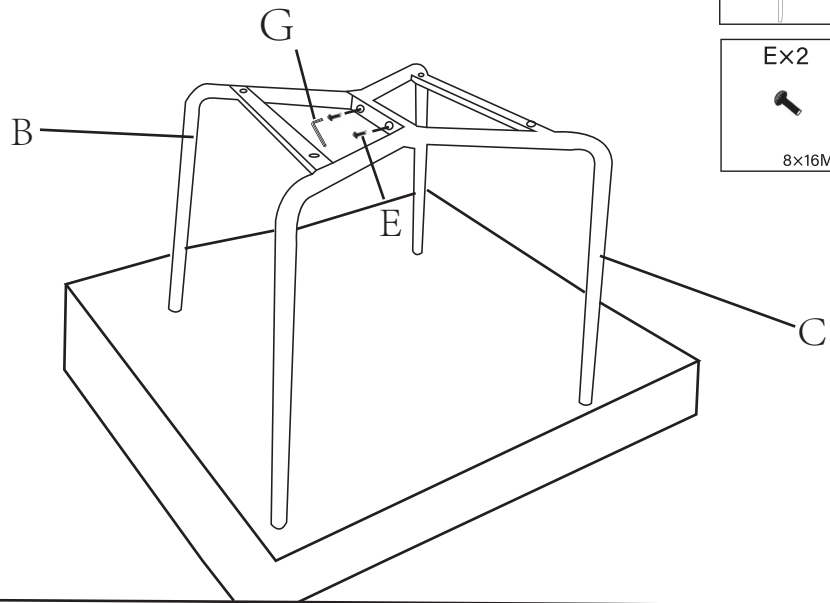

- | | |
|-------------------|----------------|
| Bx1
 | Cx1
 |
| Ex2
8x16MM
 | Gx1
5MM
 |

2

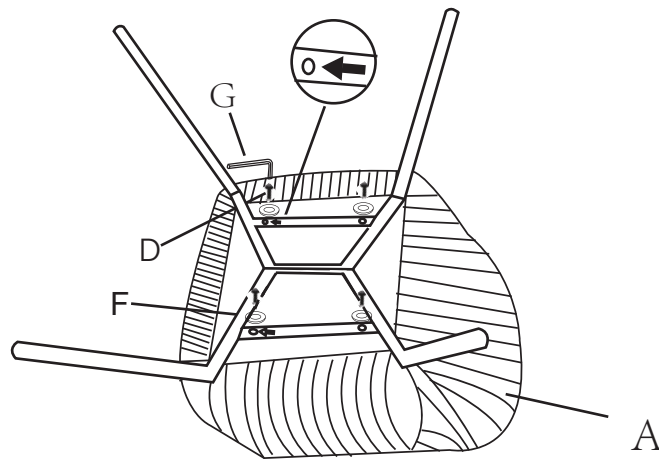

- | | |
|-----------------------|-------------------|
| Ax1
 | Dx4
6x30MM
 |
| Fx4
6x16x1.5mm
 | Gx1
5MM
 |

3



2-2

