











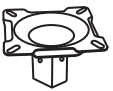

A	1x	B	1x	C	1x	D	1x	E	1x	F	1x
											
G	4x	H	4x	I	10x	J	14x	K	1x	L	8x
		 M6x10mm		 M6x25mm		 Φ6x Φ16mm		 5#		 M8x20mm	
M	1x										
 6#											



1

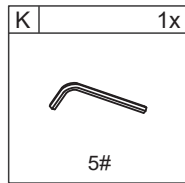
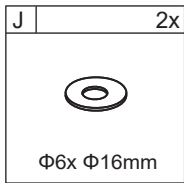
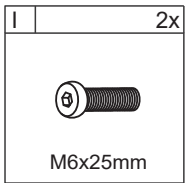
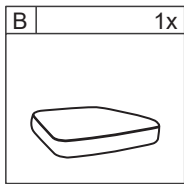
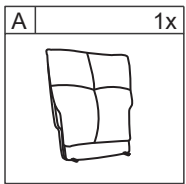
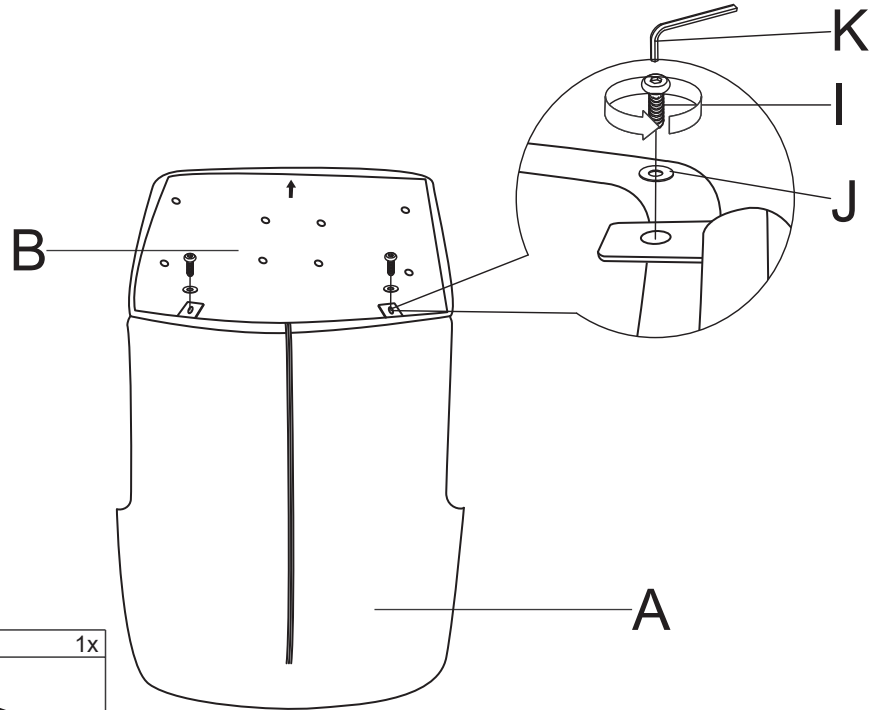

2

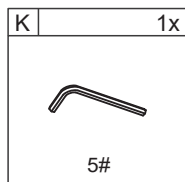
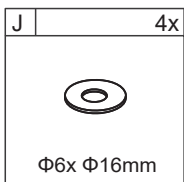
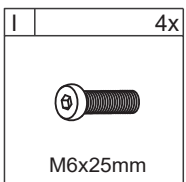
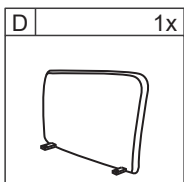
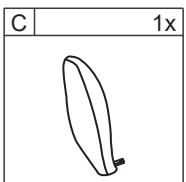
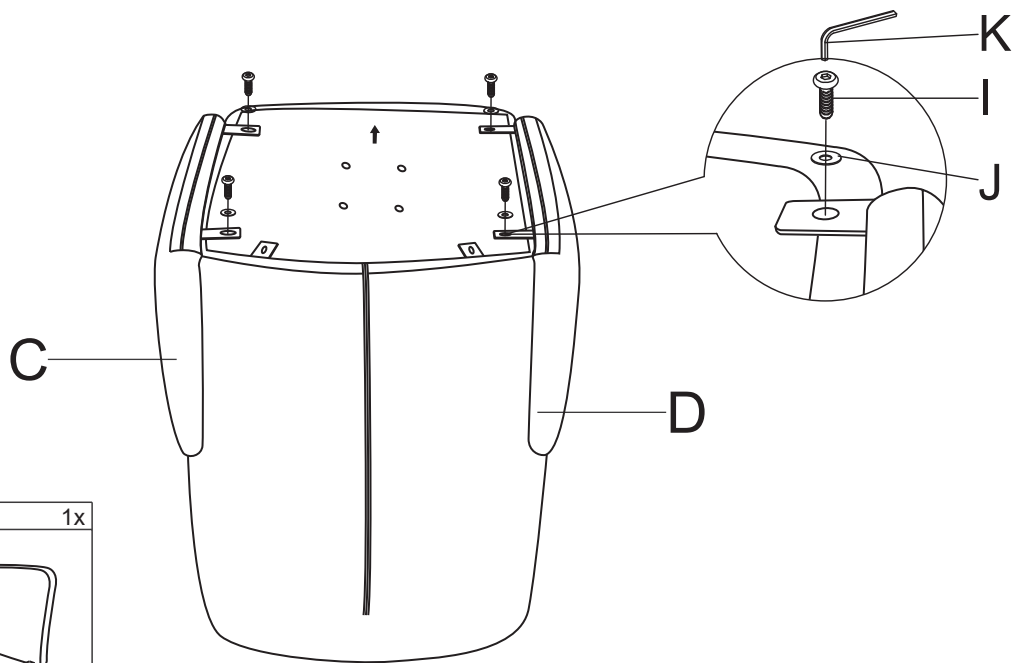

3

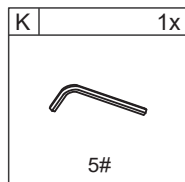
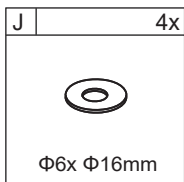
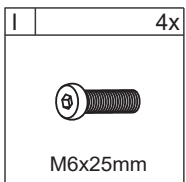
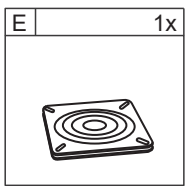
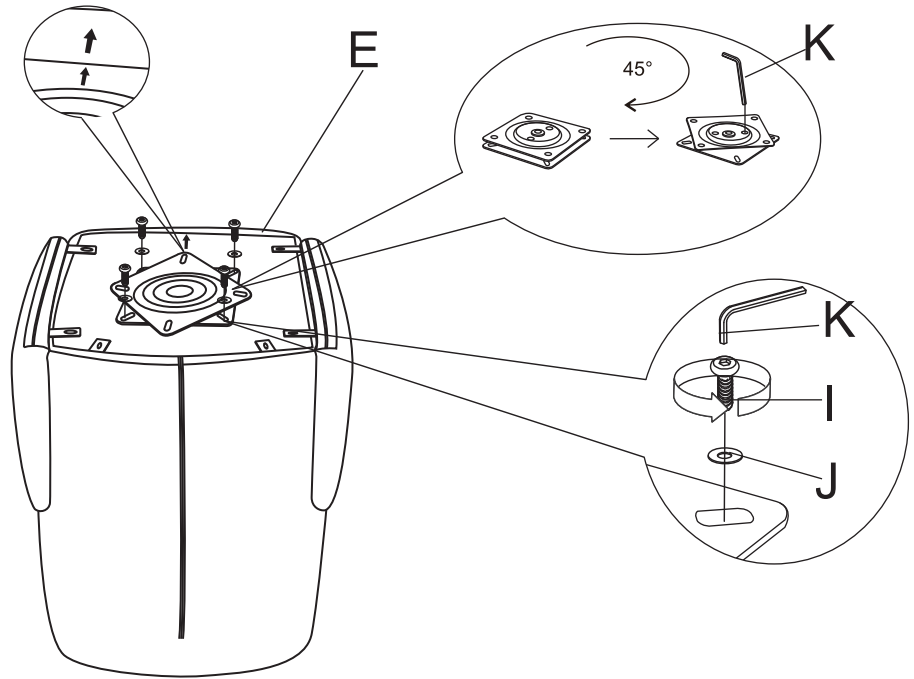

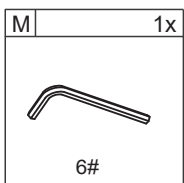
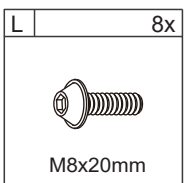
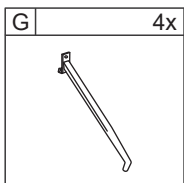
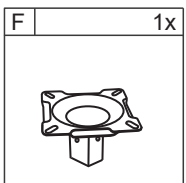
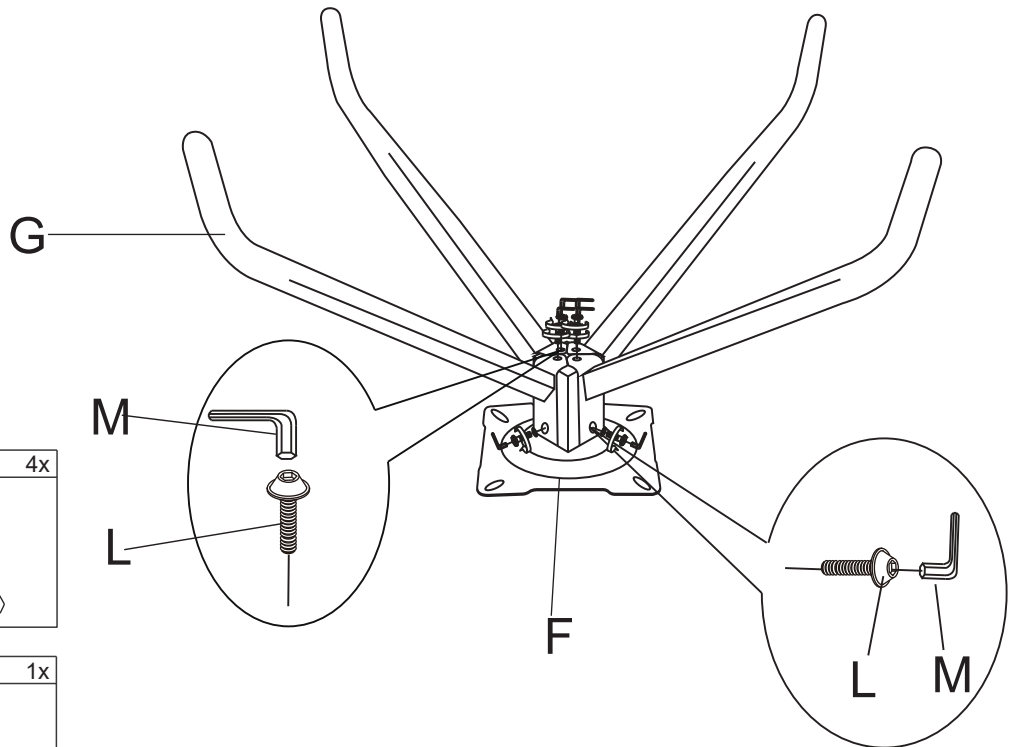

4

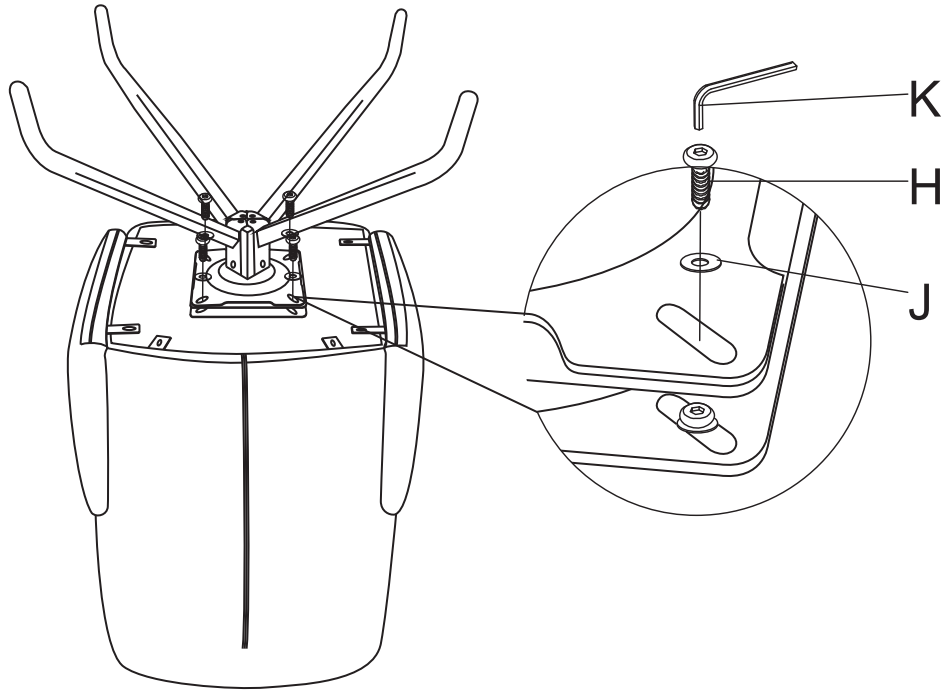

5



H	4x	J	4x	K	1x
					
M6x10mm		Φ6x Φ16mm		5#	

6

