

1.

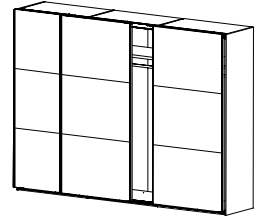

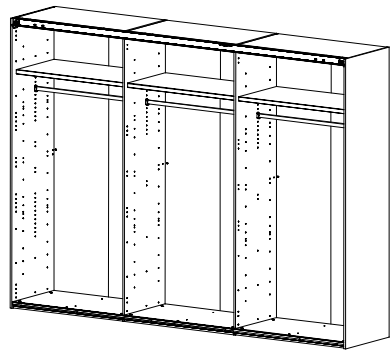

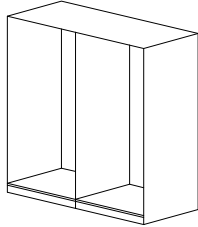

2.

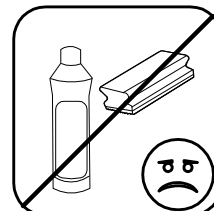
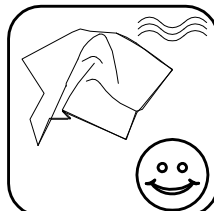
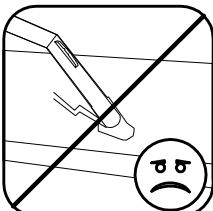
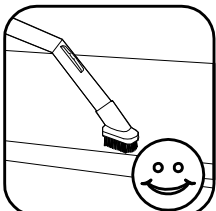
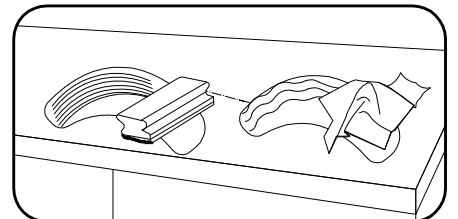
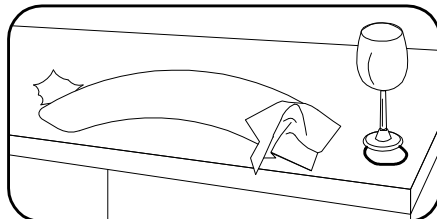
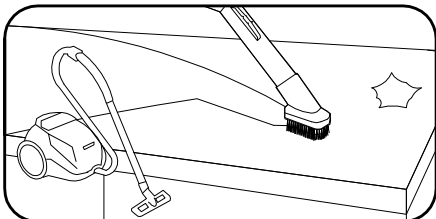
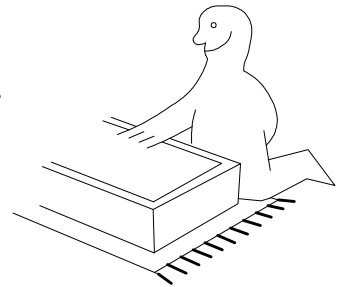
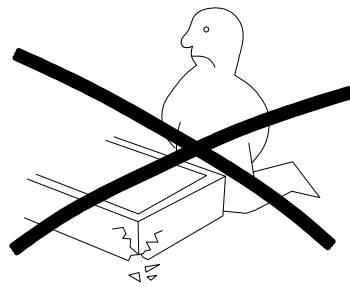
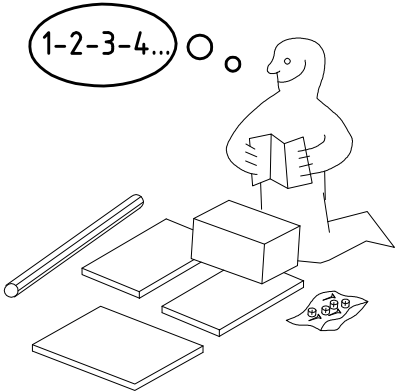
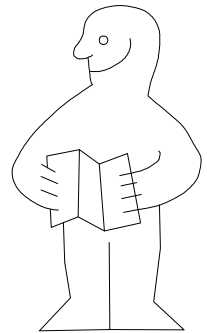
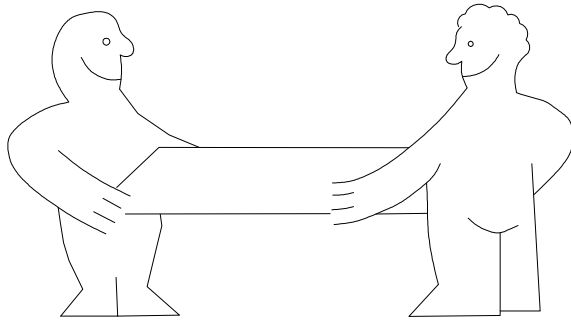
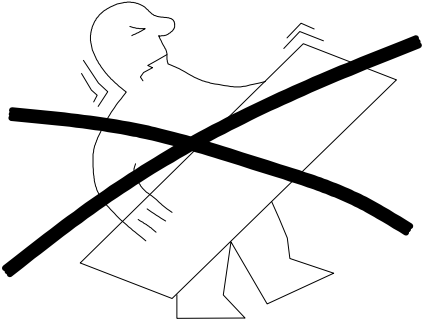

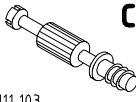



HSP 300 3trg



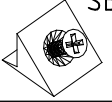

 111 149	A1	24x
 111 103	C	8x
	F3	8x

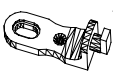

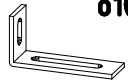

 111 300	S0	15x
 111 xxx ø12	V12	15x
 121 370	G1	42x

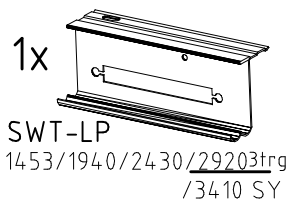
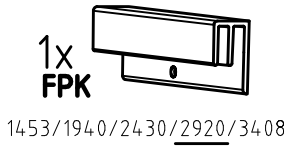

 117 002	K2	6x
 100cm	SBV	24x
 112 400	K10	3x

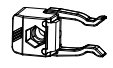
 111 611	J2	9x
 6,3 x 10,5 mm 112 055	T1	36x
 111 607	L8	12x

 111 052	o10	1x
 4 X 13mm 121 122	SP13	4x

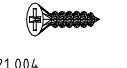
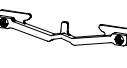

 121 xxx	SWT-ST	2x
 M4 x 13 mm 121 xxx	SWT-SM5 GH13	2x
 M4 x 10 mm 121 xxx	G13	6x
 M4 x 10 mm 121 xxx	G43	6x
 3,5 x 35 mm 121 375	G14	4x

 121 004	SWH-SKL	1x
 3,5 x 22 mm 121 004	SWH-SKR G24	1x
	SW-SM	9x
	SW-STM	1x

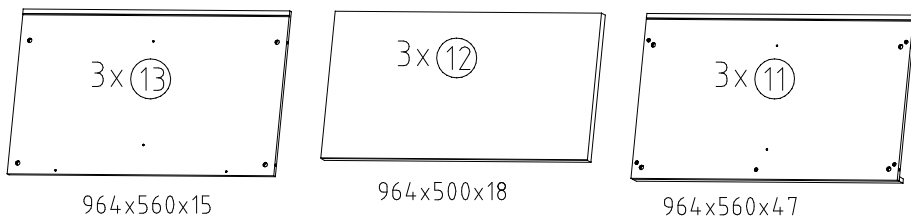
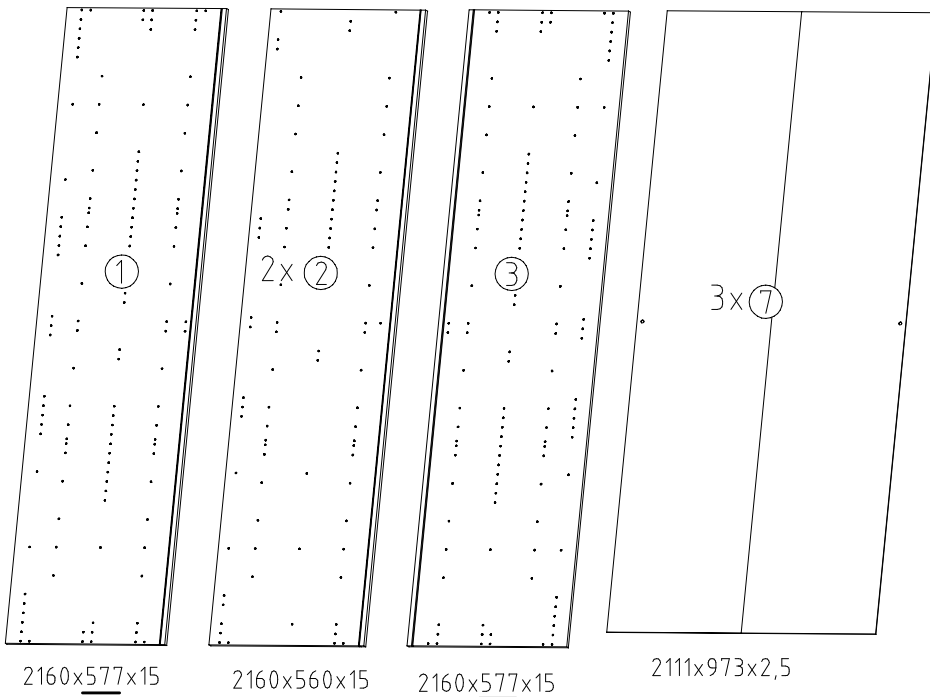
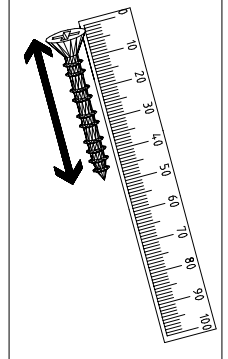
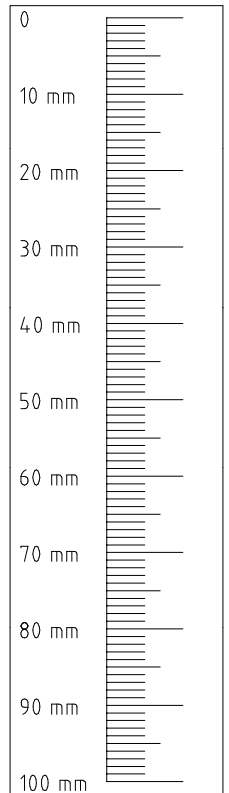
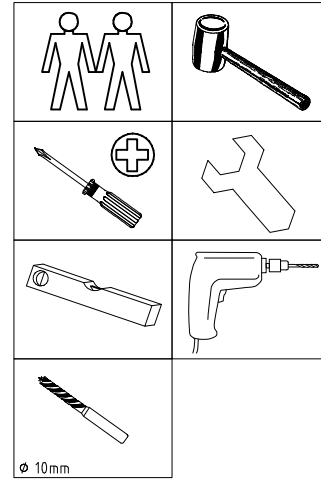

1

3,5 x 15 mm

G1

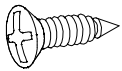

121 370

S0

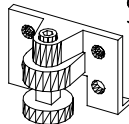

111 300

A1

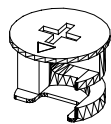

111 149

3

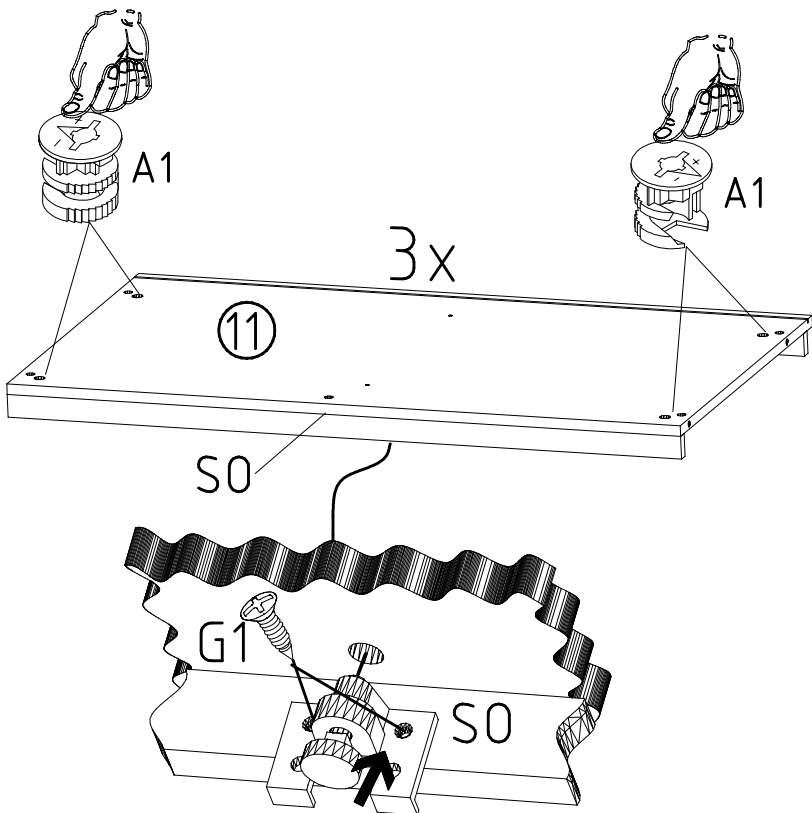

2

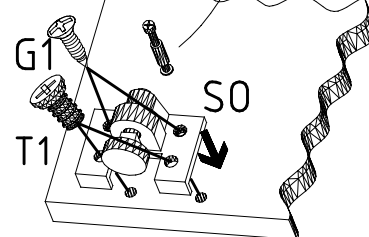
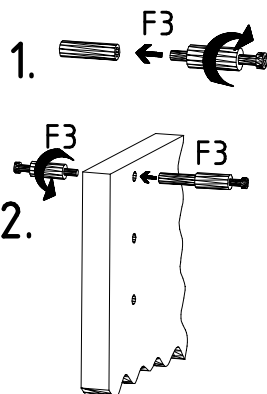
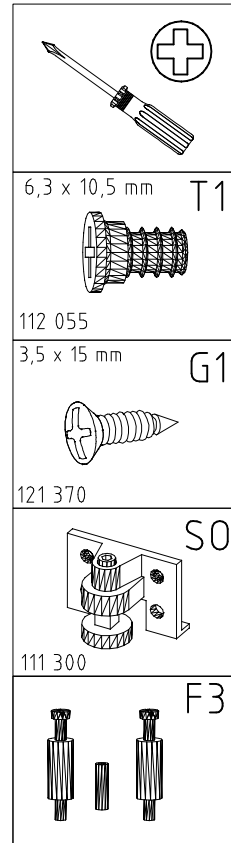
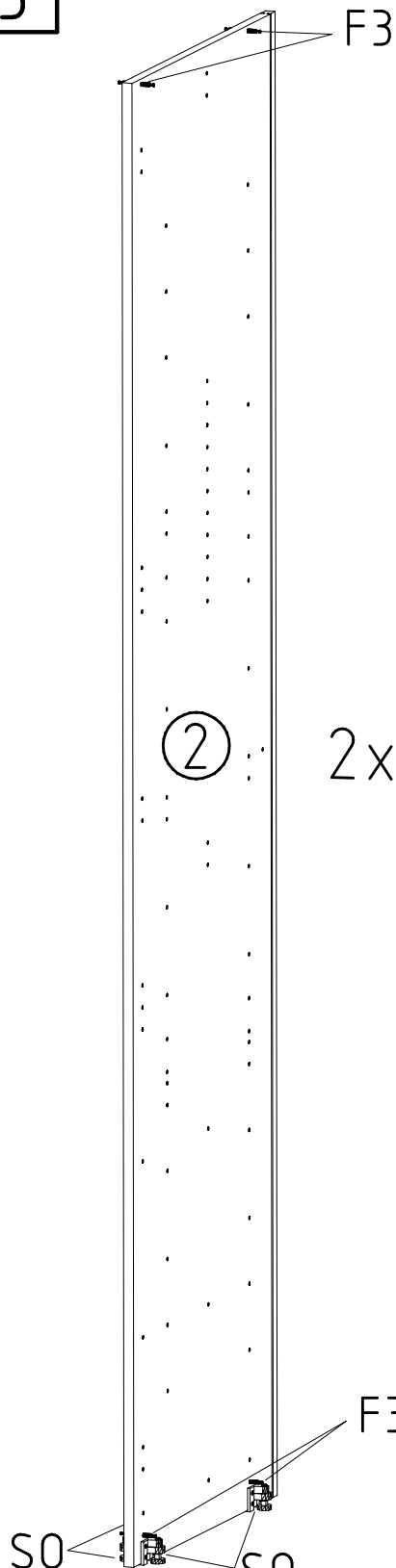
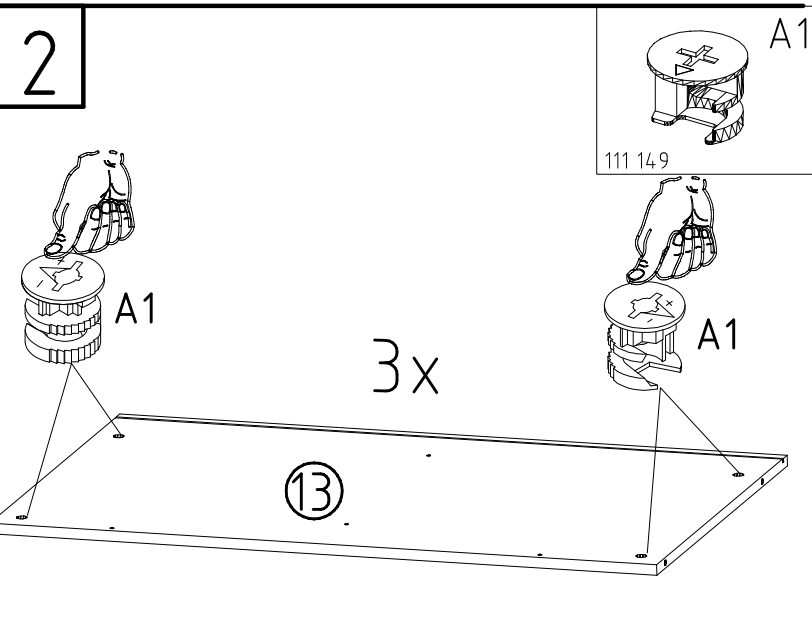

4

SWH-SKL

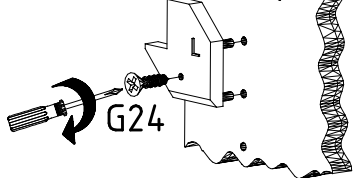

SWH-SKR

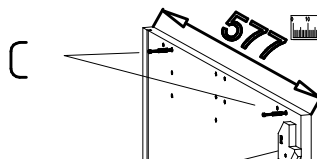
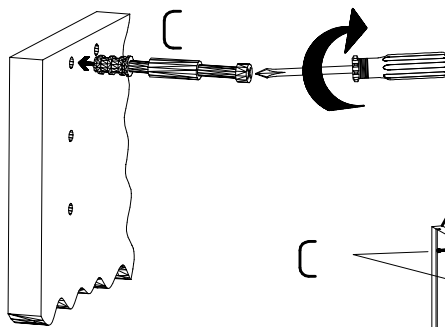
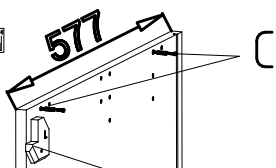
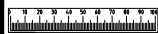
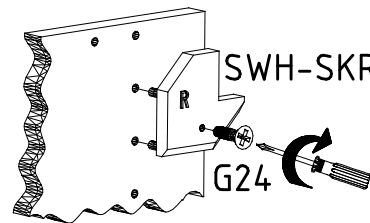

SWH-SKL +G24

SWH-SKR +G24

1

3

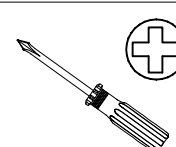

SWH-SKL

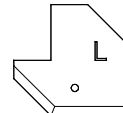

SWH-SKR

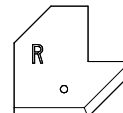

3,5 x 22 mm G24

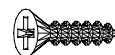

121 004

6,3 x 10,5 mm T1

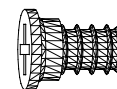

112 055

3,5 x 15 mm G1

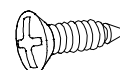

121 370

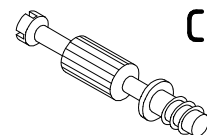

111 103

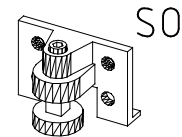

111 300

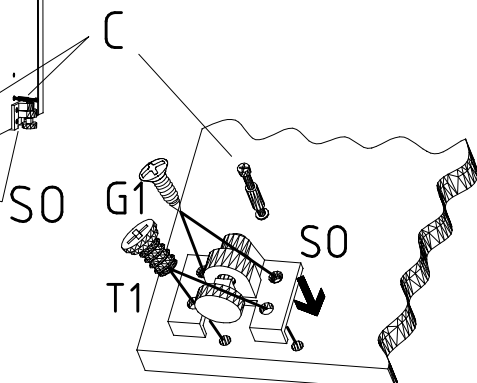

5

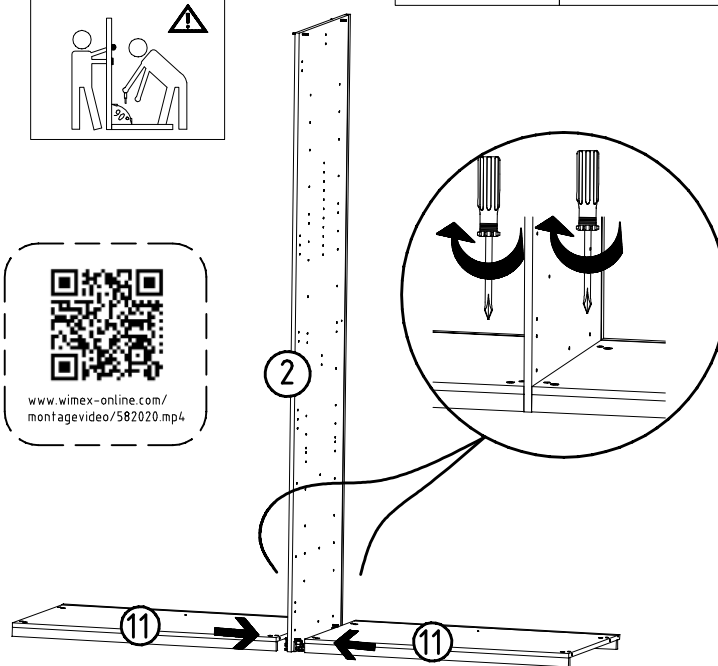
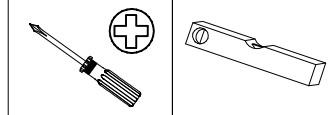

6

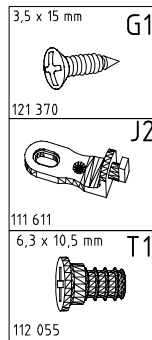
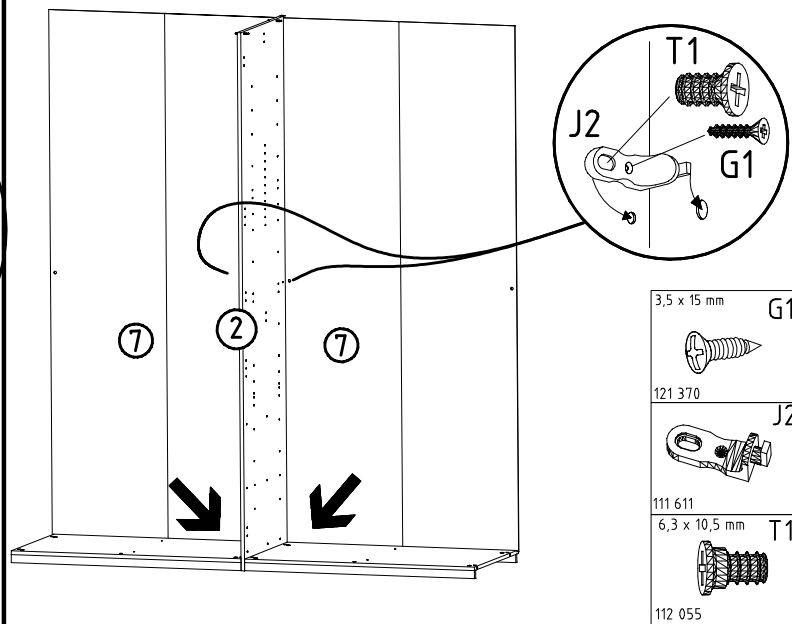
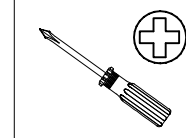

7

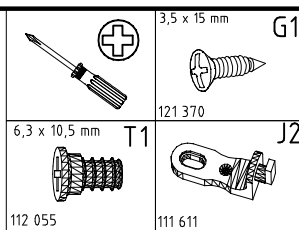

8

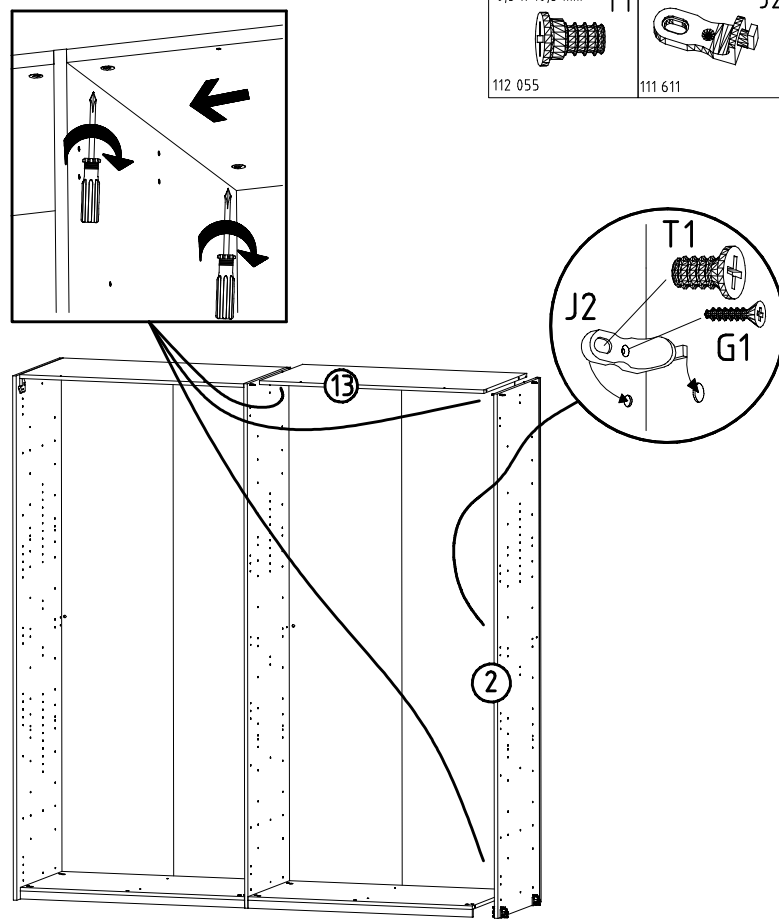
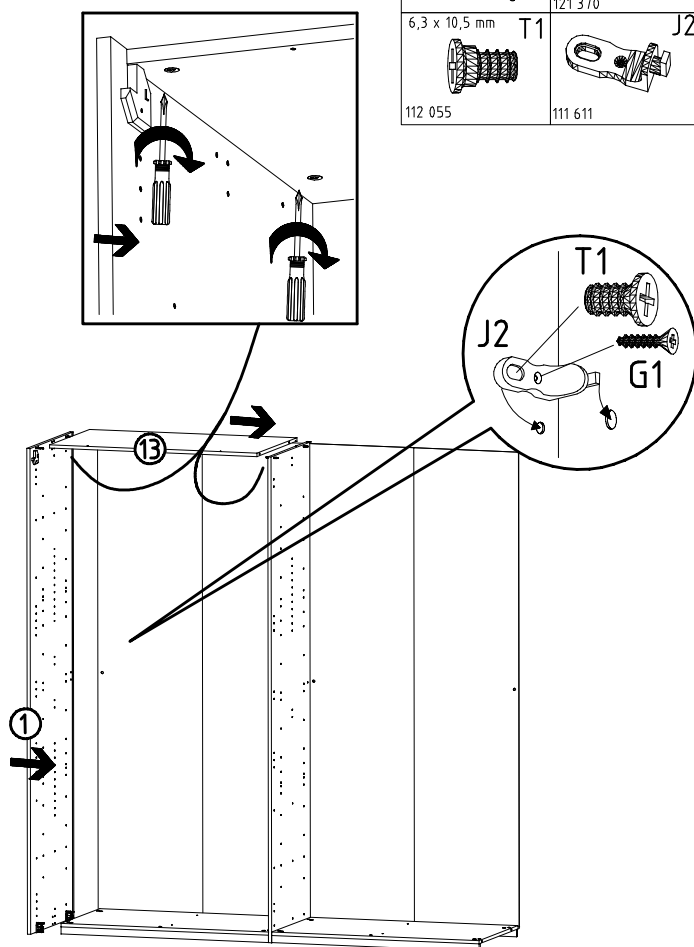
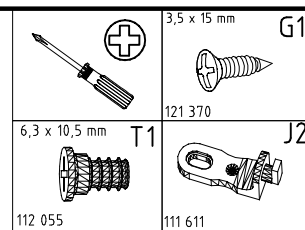

980724

29.11.16 / 01.12.17

12 17

5/11

9

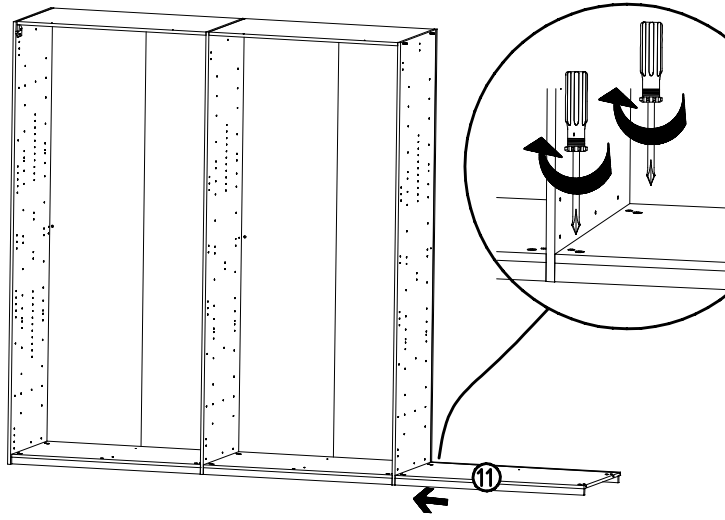
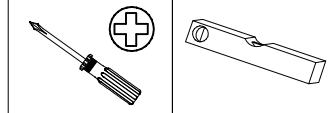
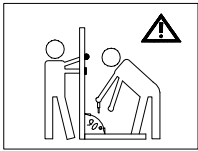

10

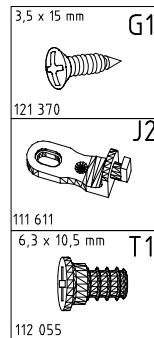
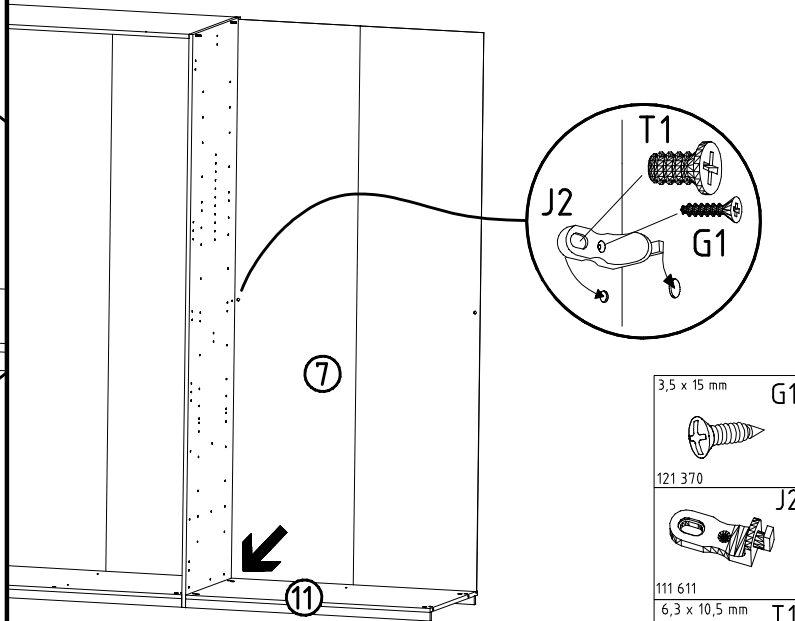
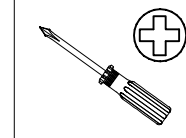

11

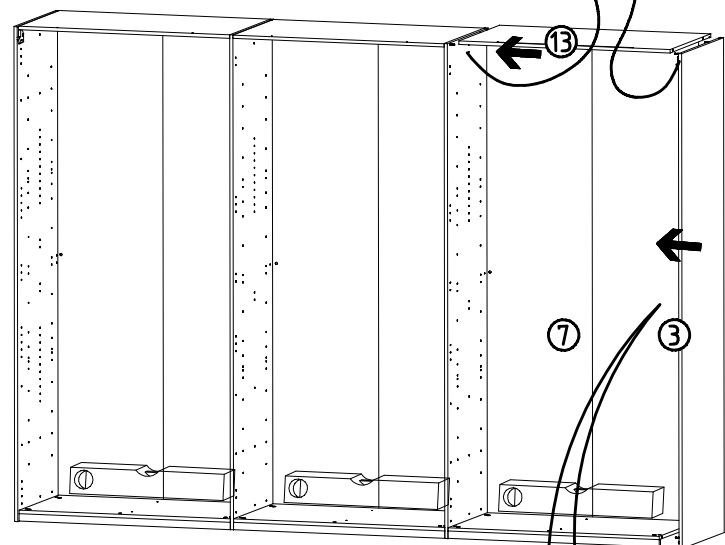
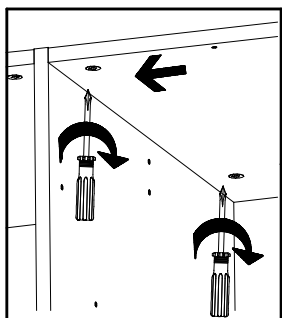
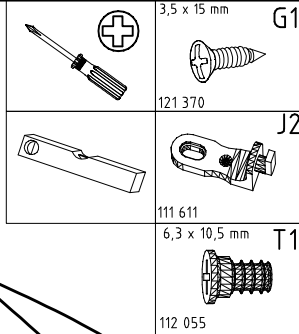

12

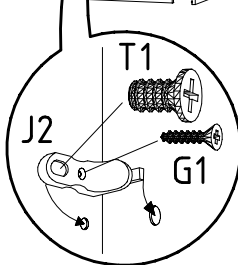
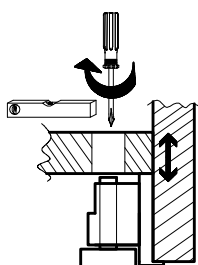
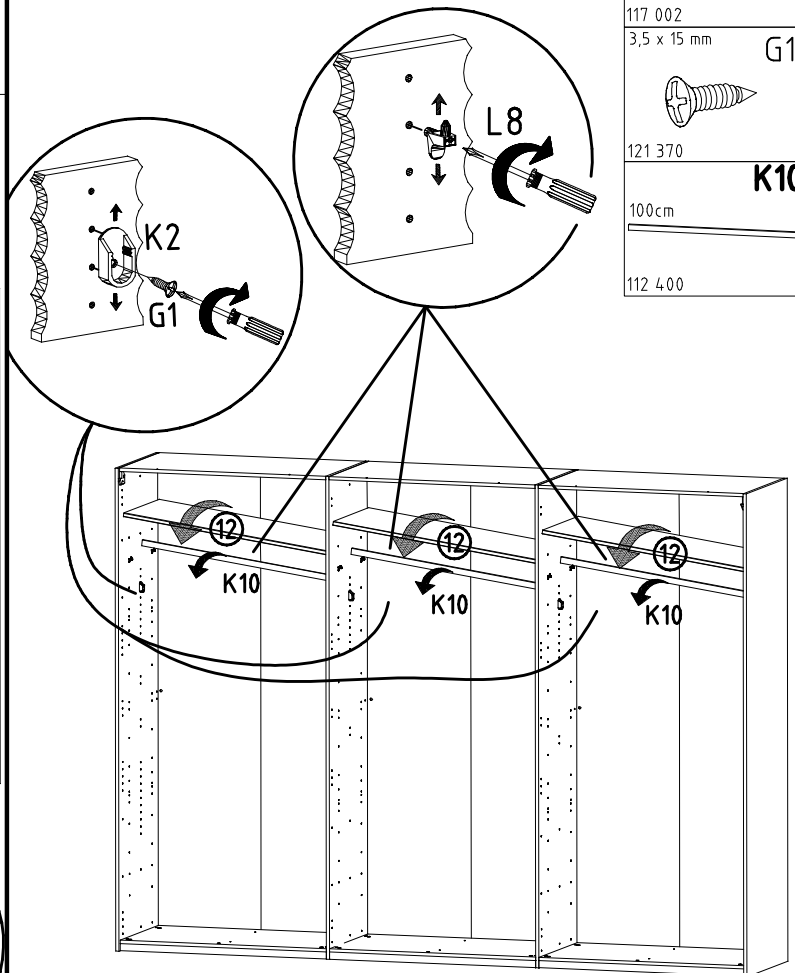
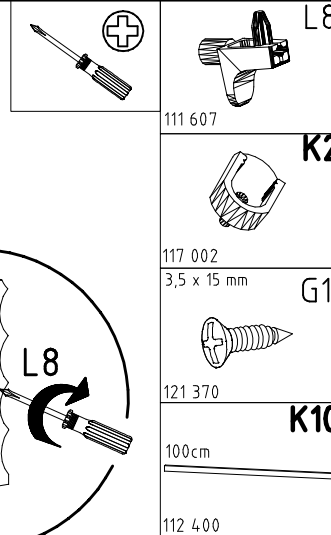

980724

29.11.16 / 01.12.17

12 17

6/11

13

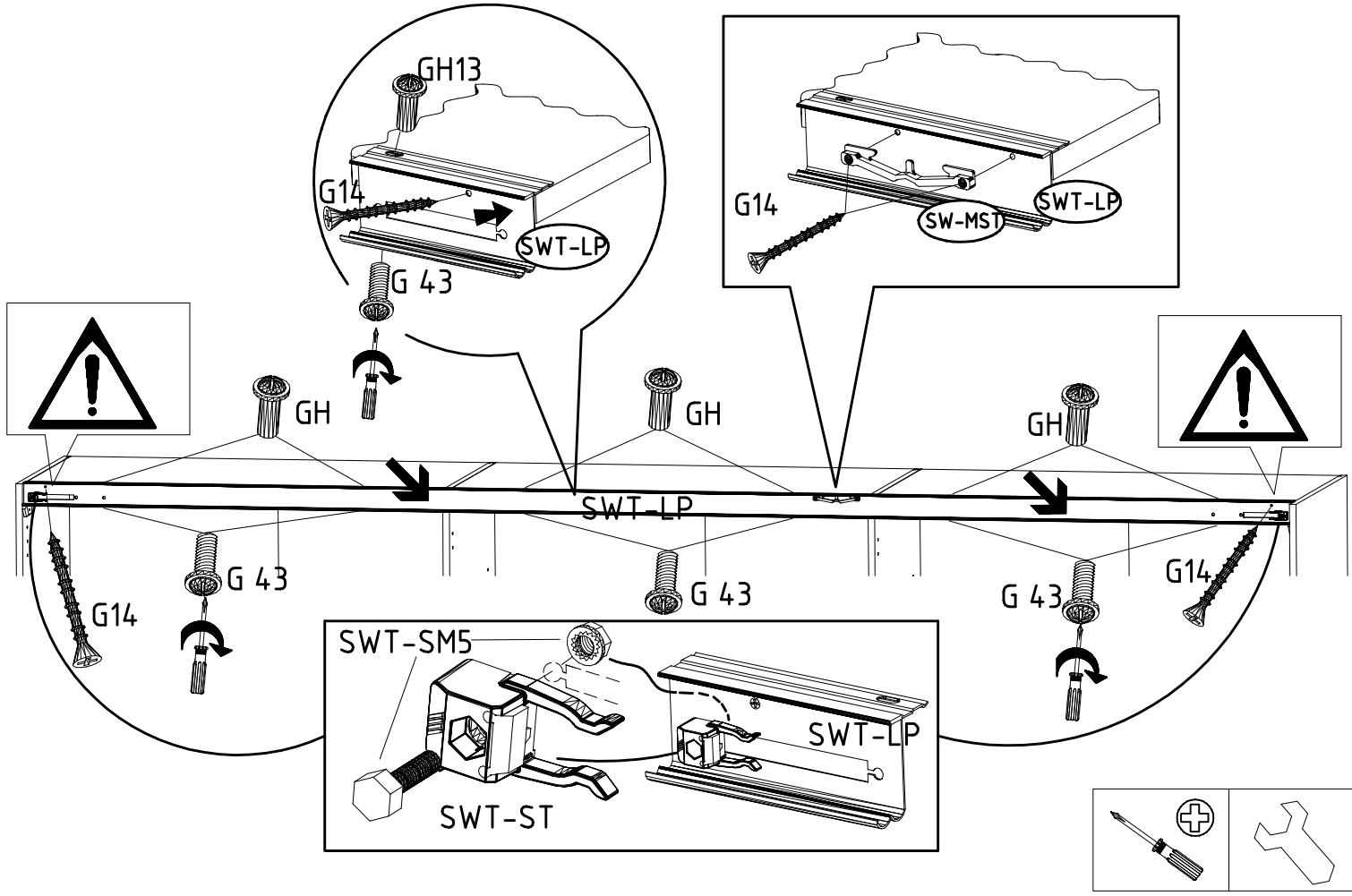
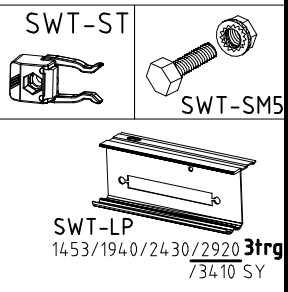
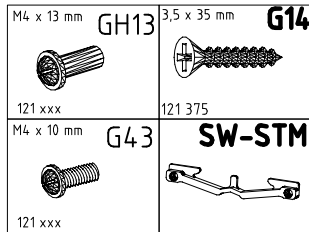
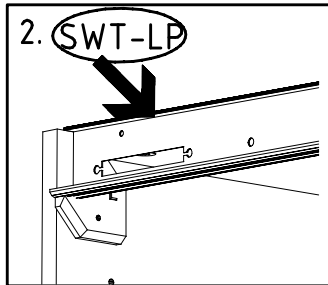
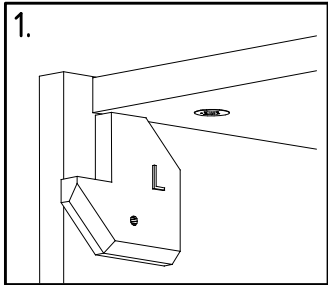

14

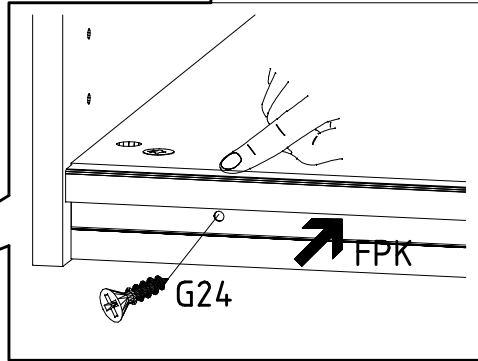
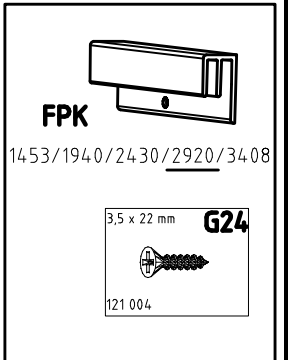
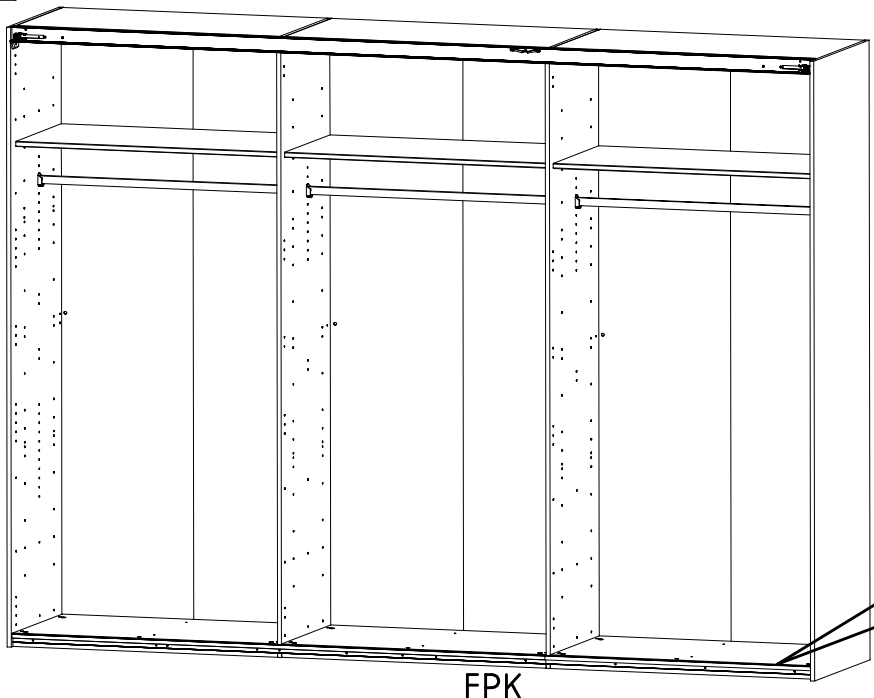

15

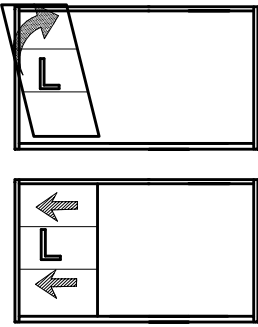

16

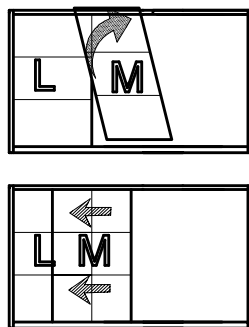

17

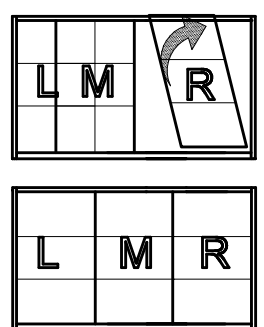

15 + 17

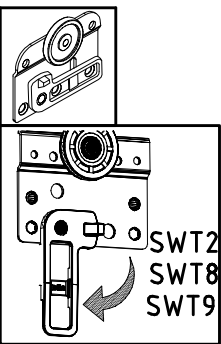
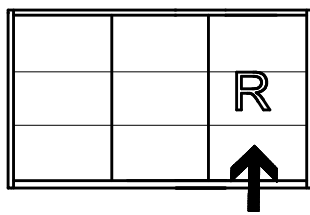
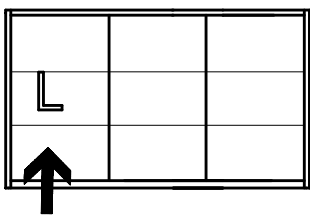

I.

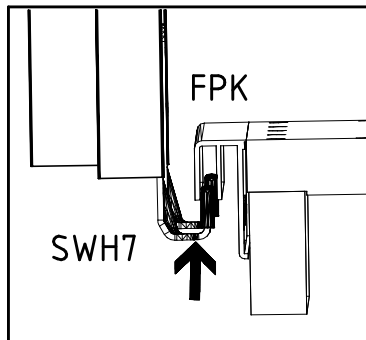

II.

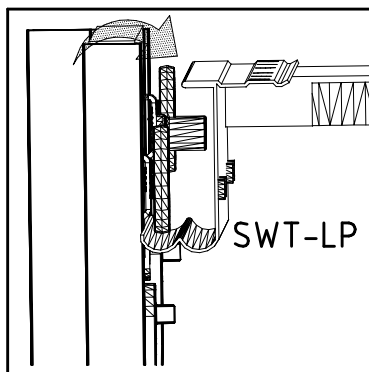

III.

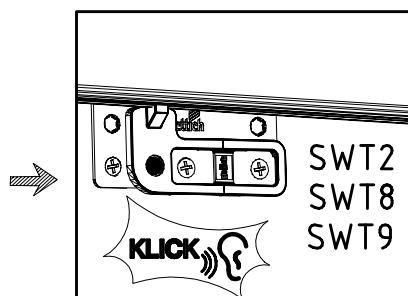
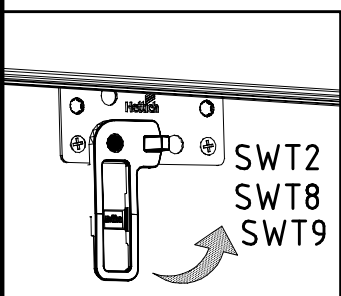

16

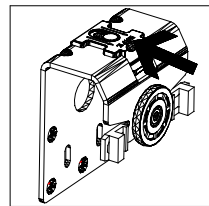
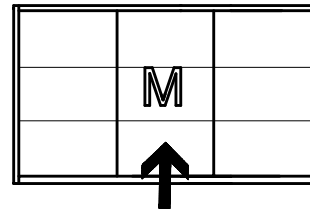

I.

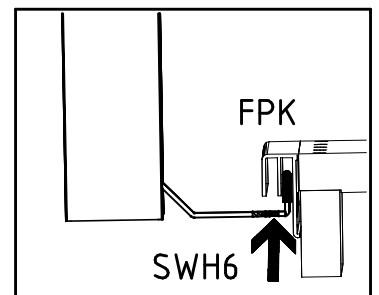

II.

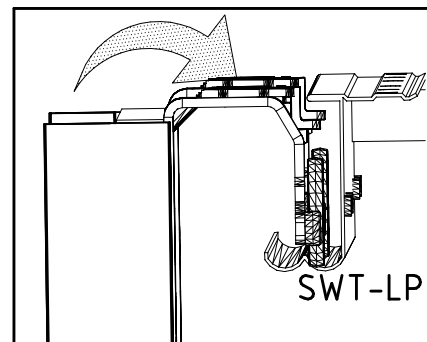

III.

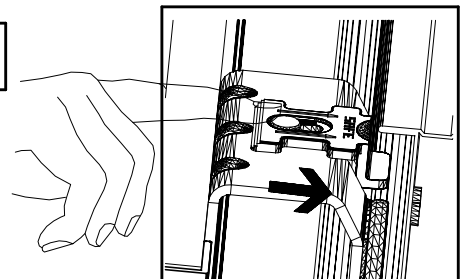



18

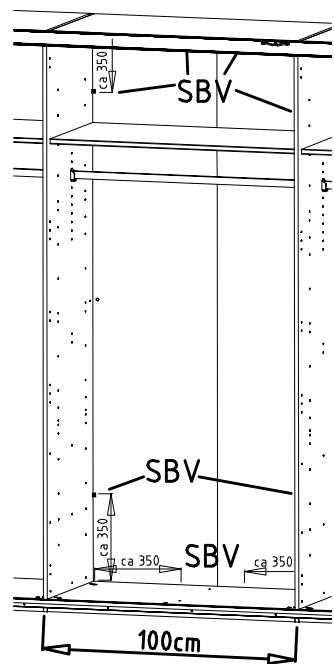
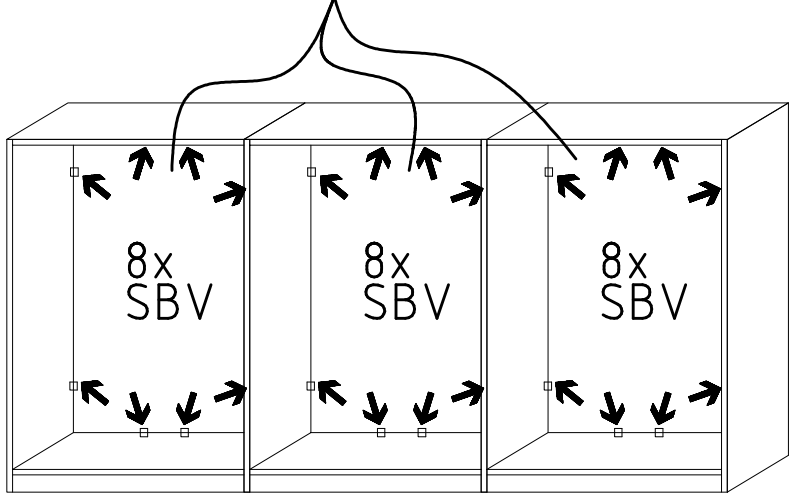
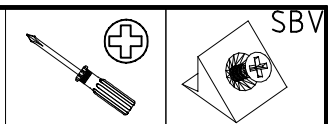
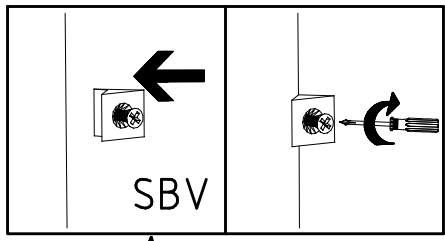

19

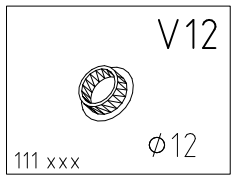
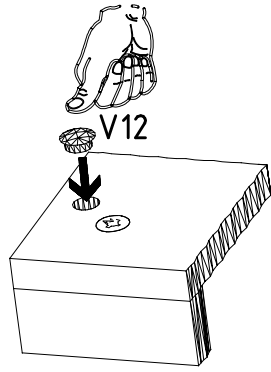
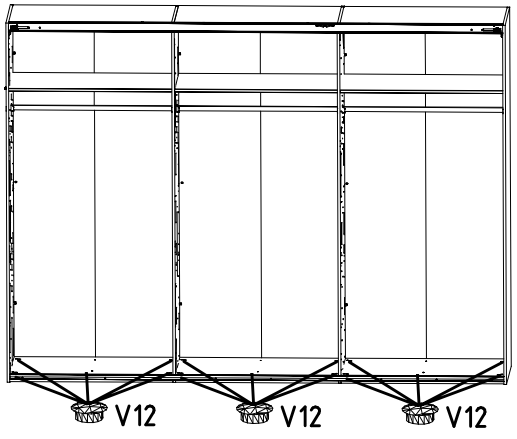

20

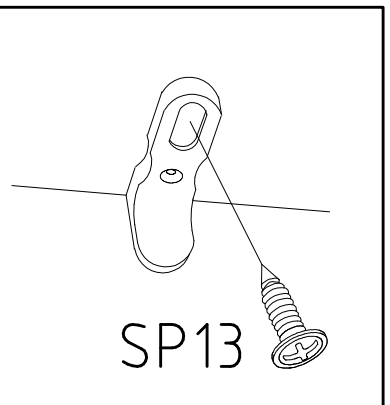
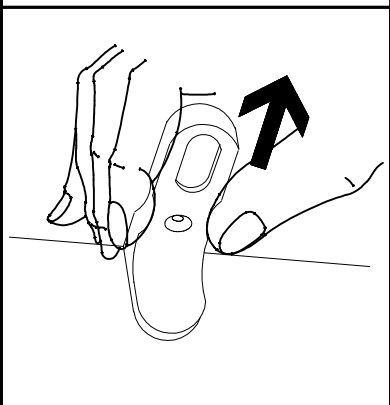
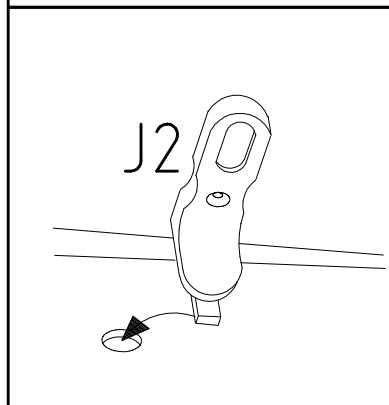
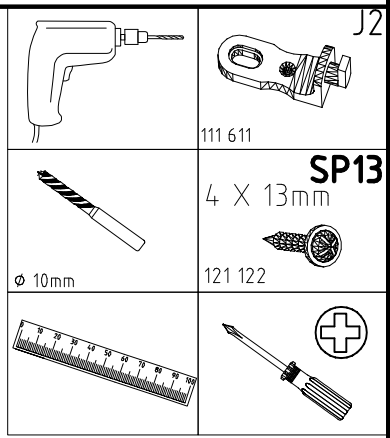
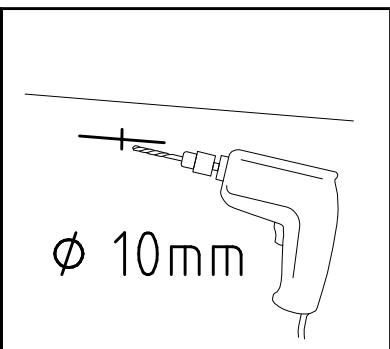
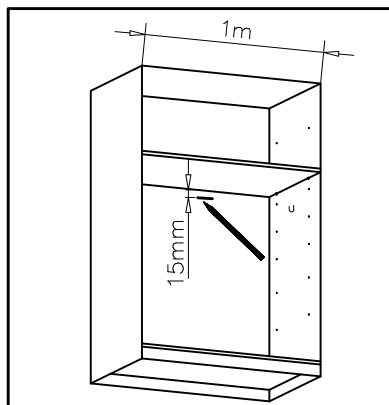

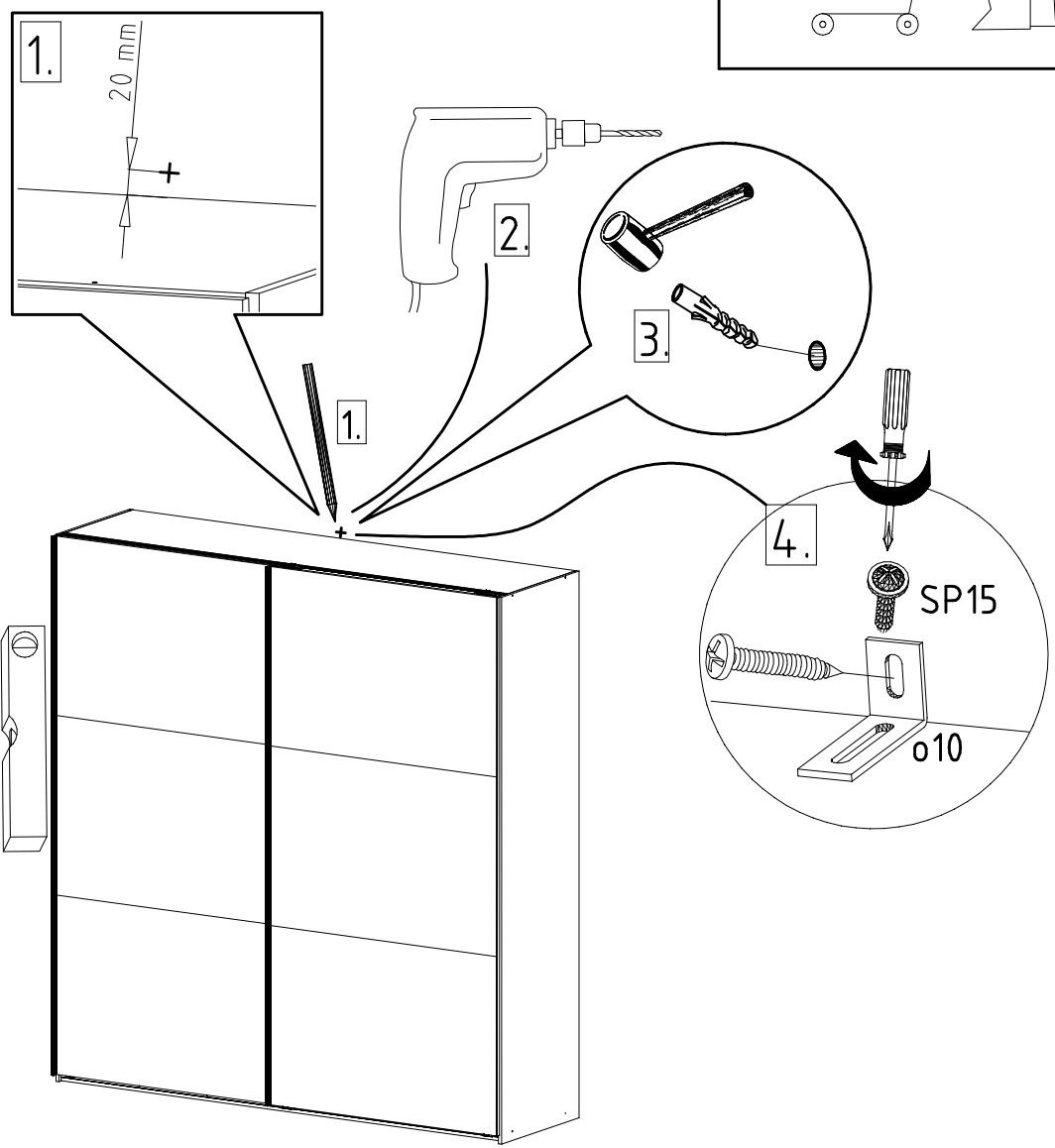
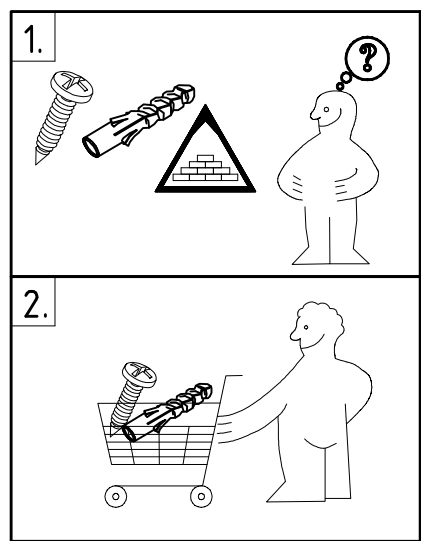
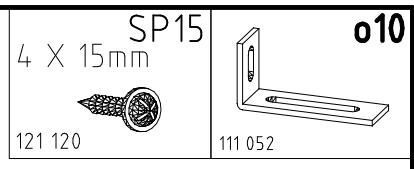
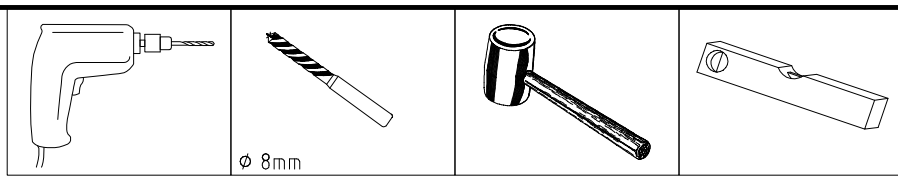

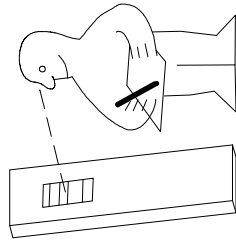
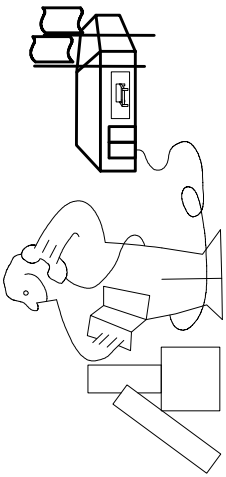
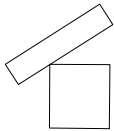
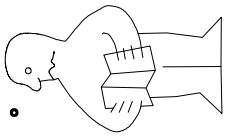

Modell/Model/Modèle

\_\_\_\_\_  
\_\_\_\_\_  
\_\_\_\_\_



\_\_\_\_\_  
\_\_\_\_\_  
\_\_\_\_\_  
\_\_\_\_\_  
\_\_\_\_\_

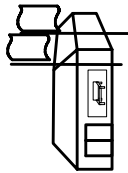

\_\_\_\_\_  
\_\_\_\_\_  
\_\_\_\_\_  
\_\_\_\_\_

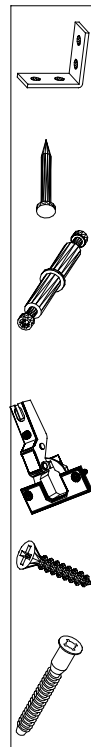

{121 370}	{ G 1 }	{4x}

Änderungen die dem technischen Fortschritt geschuldet sind, behalten wir uns vor !

Bei nicht vorschriftsmäßiger und/ oder nicht fachmännischer Montage wird bei Personen- und/ oder Sachschäden keinerlei Haftung übernommen.

WIMEX Wohnbedarf/ Import Export Handels GmbH/ Postfach 1407/ 49112 Georgsmarienhütte/ Germany  
Tel.:(+49) 05401 8598 72 Fax.:(+49) 05401 8598 33 Mail: service\_H@wimex-online.com

104P-Nr. / 104P-No.    150X-Nr. / 150X-No.    Auftrag/Order-No. / No. de Commande

**23203**    **30110XY**    104

Kunde    MAX MUSTERMANN  
Customer  
Client

Kommission / your order reference / votre reference

**3377 MINDEN**

---

Dekor / Decor    Decor / Modell / Modele

**F99**    **SAMPLE**

F99842    SCHWEBETUERENSCHRANK 250 CM H 216CM  
PLANKENEICHE NB + RAU STEEL  
PLANKENEICHE NACHBILDUNG

202320301107241476000001

Paket / Package / Paquet

**414760**

SOCKEL

Paket 1 von 8    Colli Kommission 10

HSP-SMT BOD 50 TEXT/TEX SOCKEL 32 FRESH    TV / LF 104  
SO-BOD TEXT RASTEX/ ZNBOD D18MM TX KLSTA

Montage - Anleitung    Laenge ..... 520,0    OBEREN  
KS-64    Breite ..... 568,0    OBEREN

**SOCKEL32 KLEB**

Bei Warenauslieferung für Rückgabe beachten!  
En cas de livraison veuillez retourner le bordereau d'envoi.



OBEREN 5 30/19 HAUT 23.08.19 OBEREN 1 1. JABOVE OBEREN

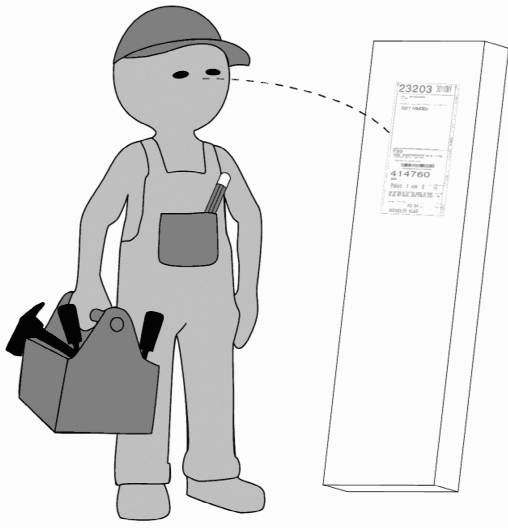

**WIMEX Wohnbedarf**  
Import Export Handelsges mbH & Co. KG  
Werner-von-Siemens-Str. 35  
D-49124 Georgsmarienhütte - Germany

**SAMPLE**    **23.08.19**  
Modellname    Produktionsdatum  
Model    Date of manufacture

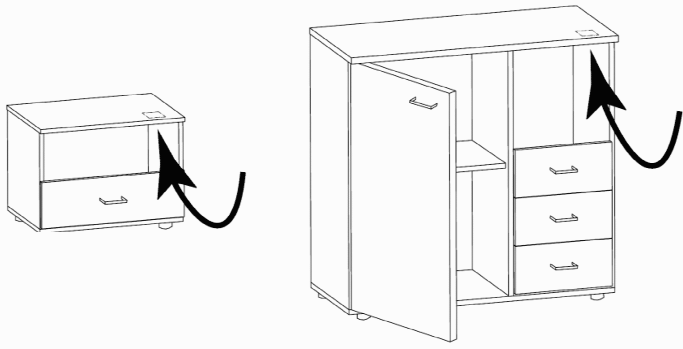
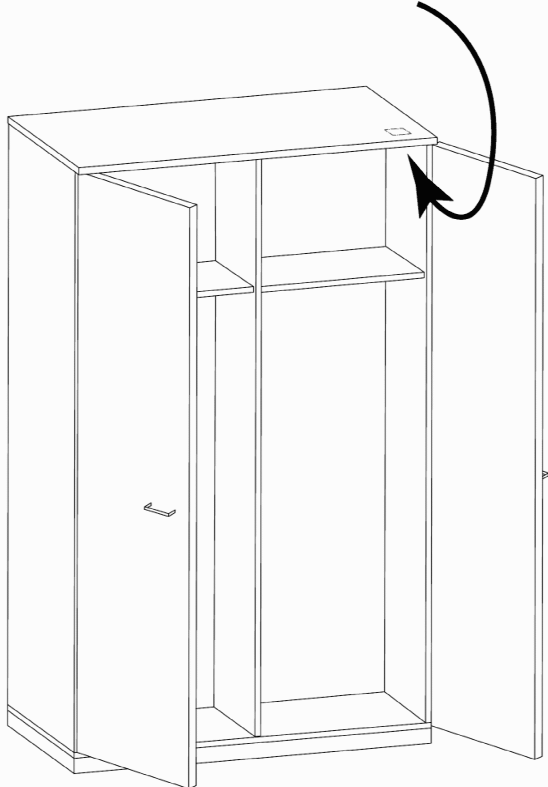
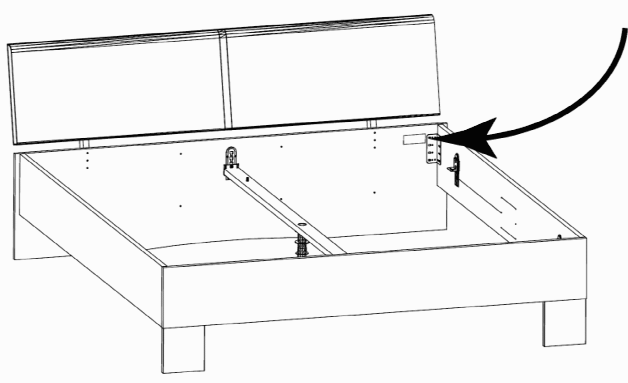

980827



1.

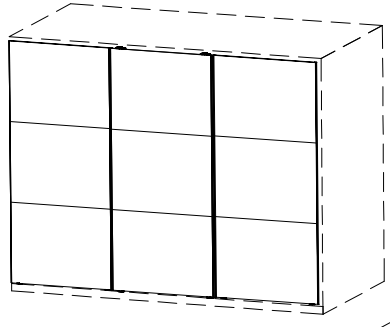
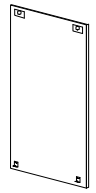

2.

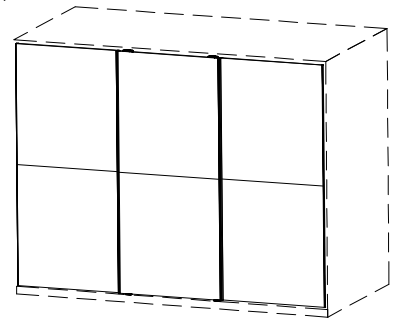
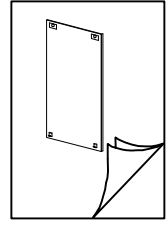
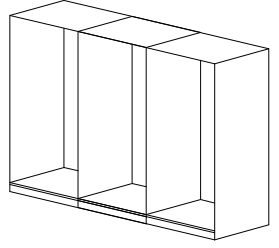
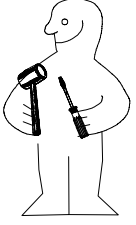

300 HSP 3Trg

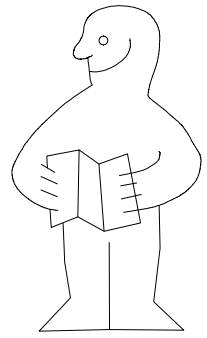
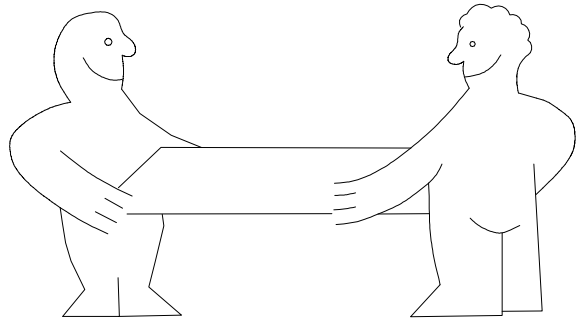
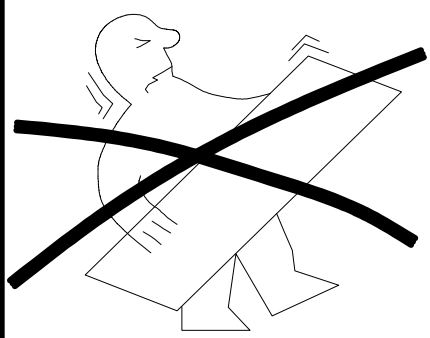

1-2-3-4... ○

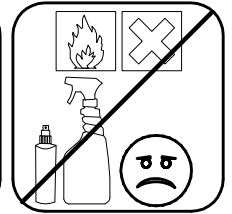
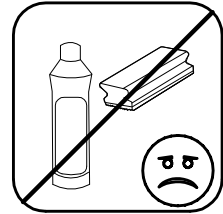
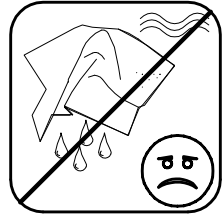
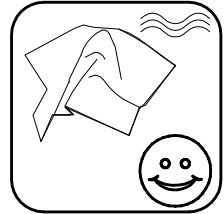
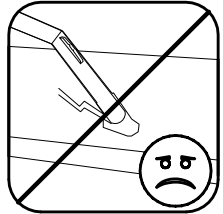
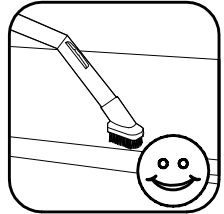
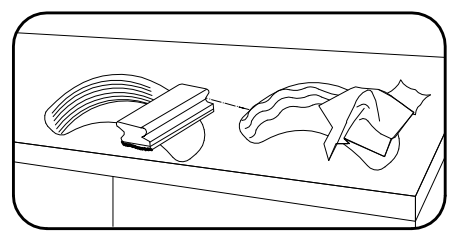
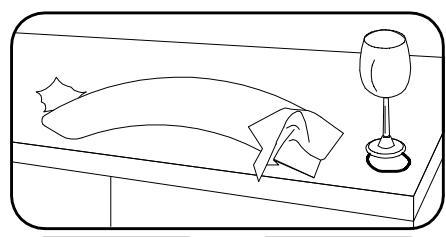
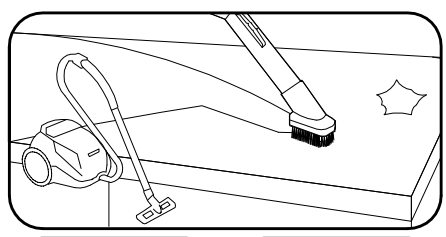
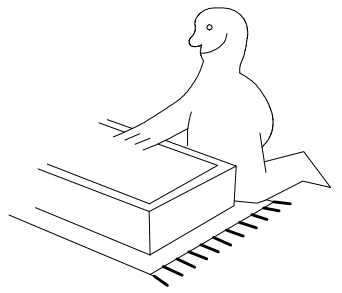
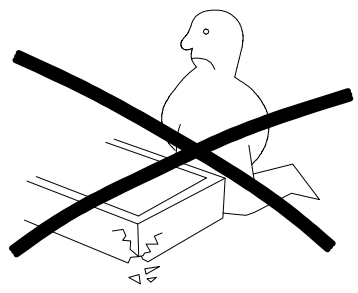
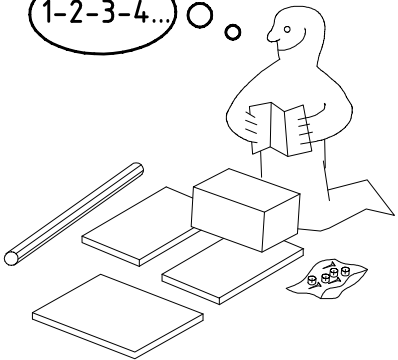

980827

03.12.16 / -

12 16

1/8

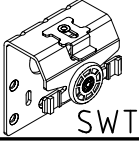
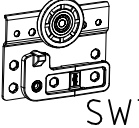
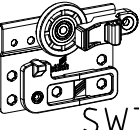
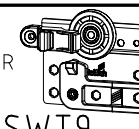
 SWT 1	2x
 SWT 2	2x
 SWT 8	1x
 SWT 9	1x

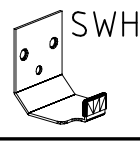
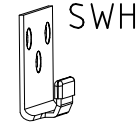
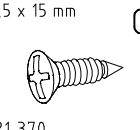
 SWH 6	2x
 SWH 7	4x
 3,5 x 15 mm G1 121 370	2x

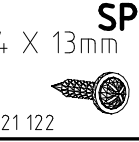
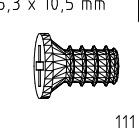
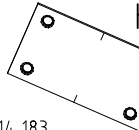
 4 X 13mm SP13 121 122	90x 102x
 6,3 x 10,5 mm T2 111 030	48x
 H5 114 183	3x 6x

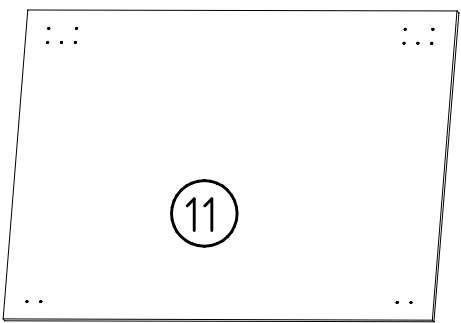
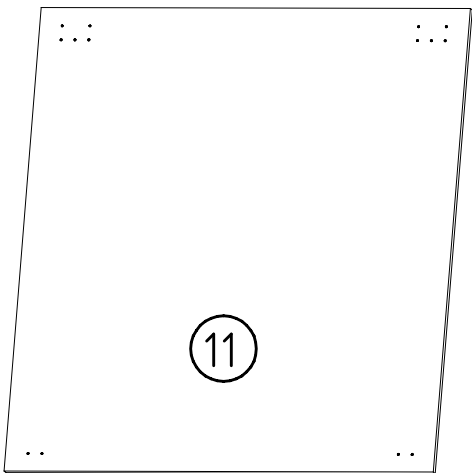
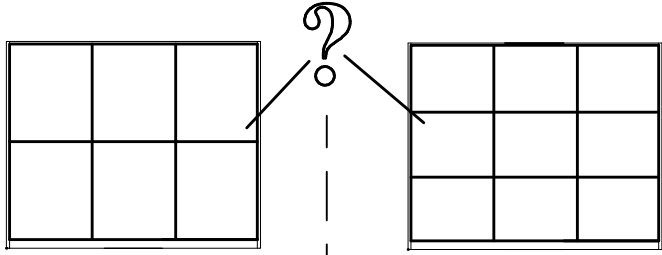
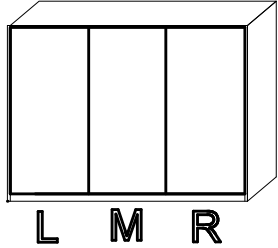
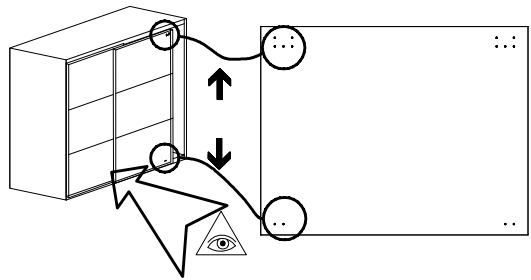
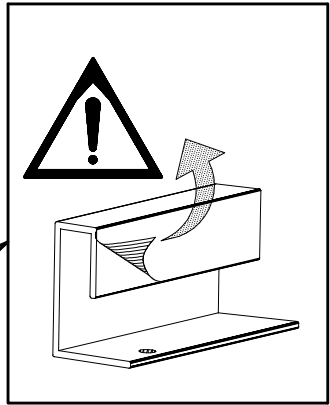
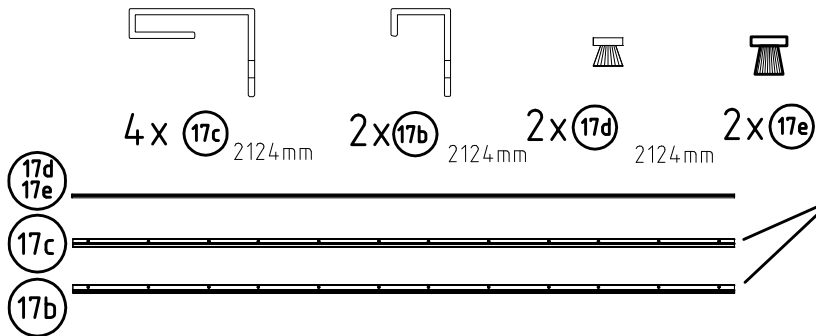
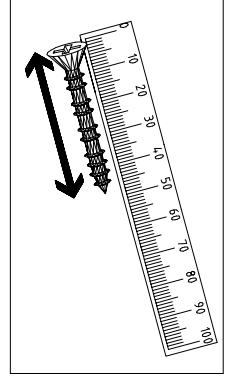
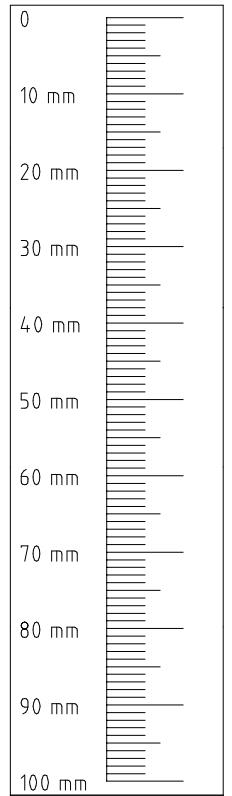
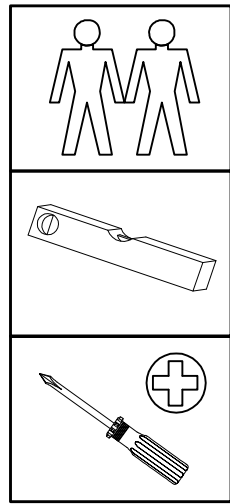

9x 990x 708 x 15

6x 990x 1062 x 15

1

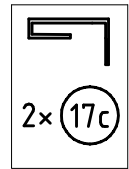
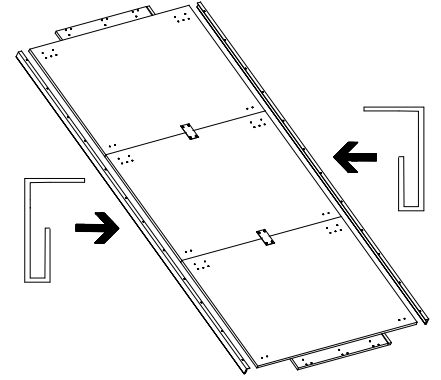
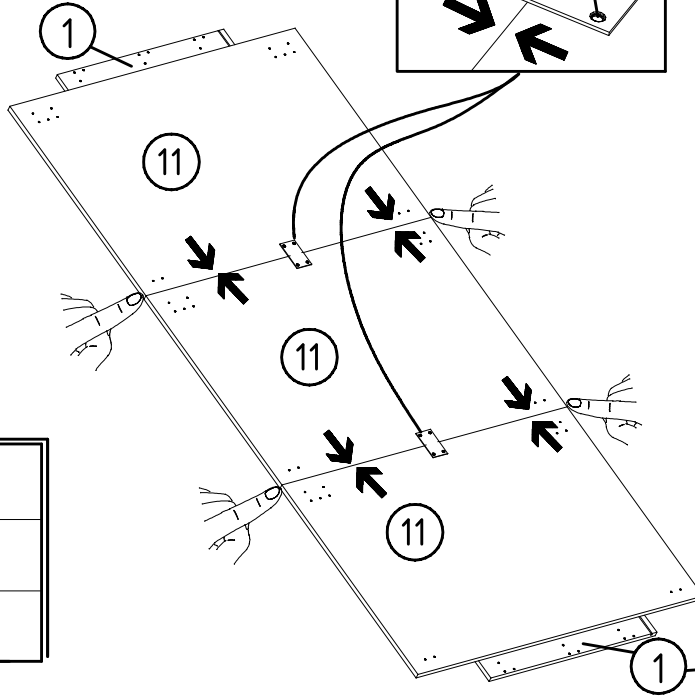
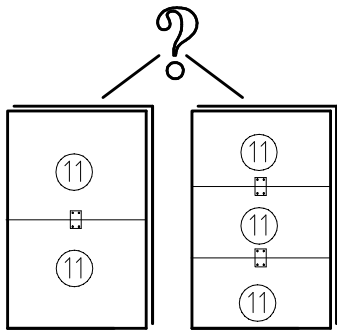
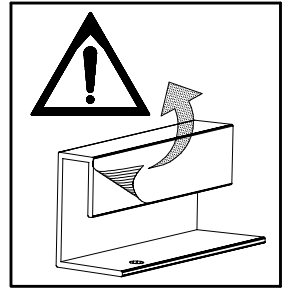
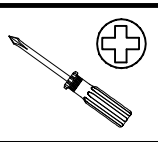
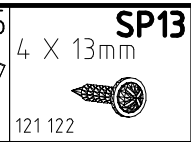
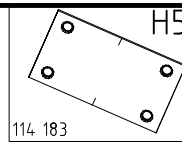
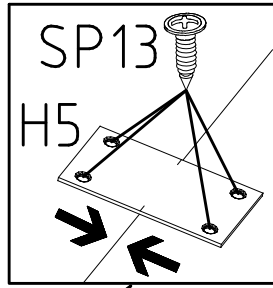
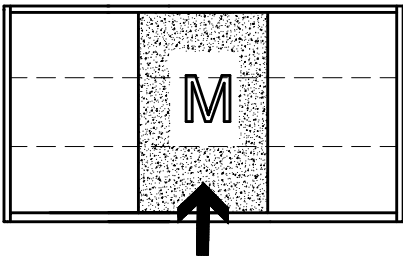

2

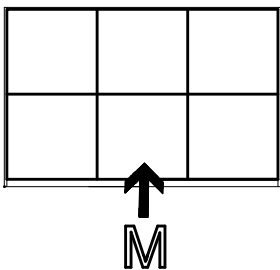
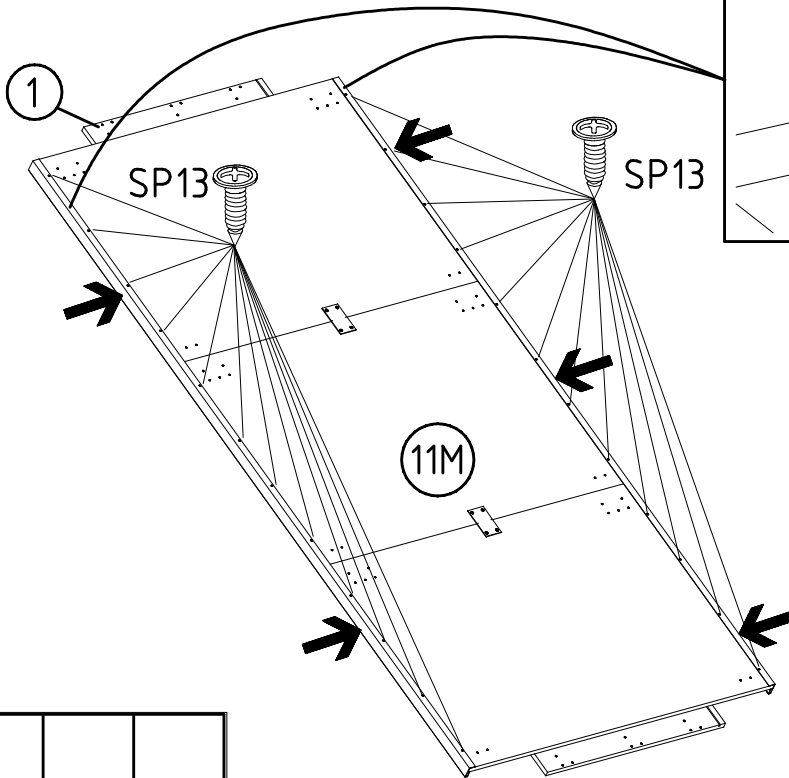
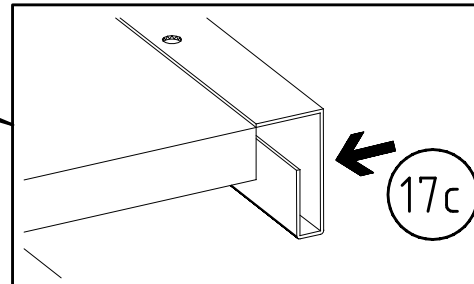
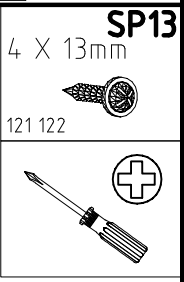

3

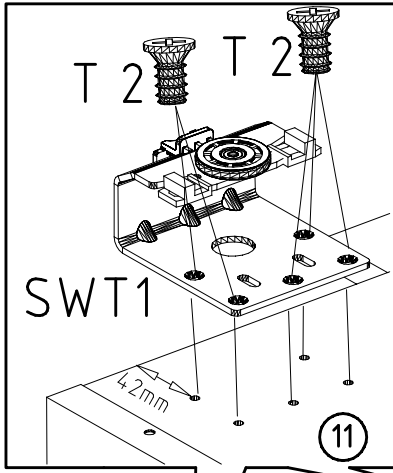
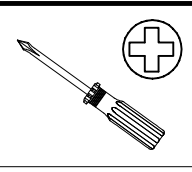
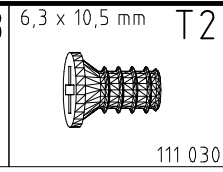
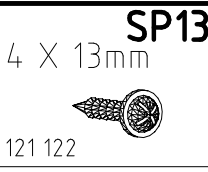
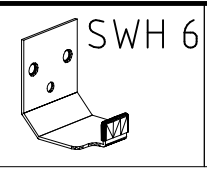
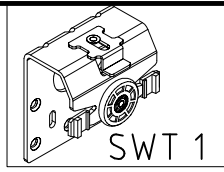

SWT1

T 2 T 2

42mm

11

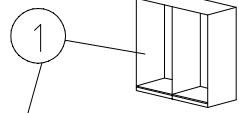

1

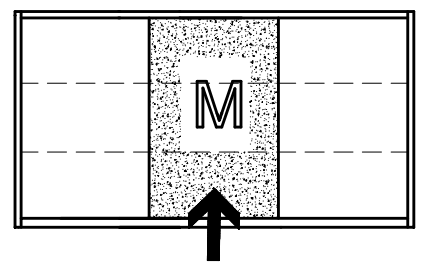

M

11

11

11M

11

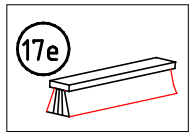

17e

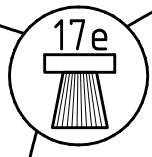

17e

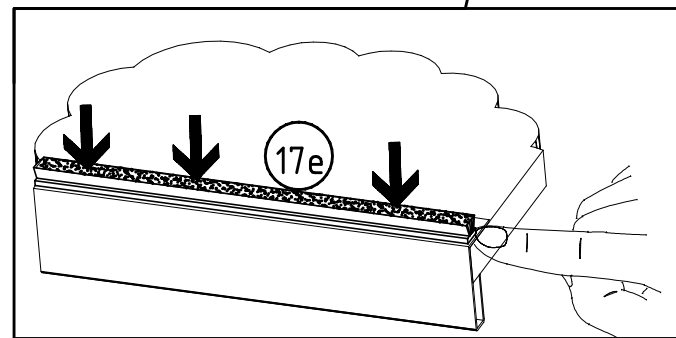
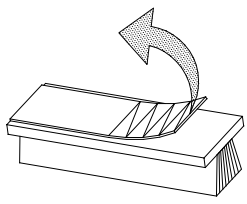

17e

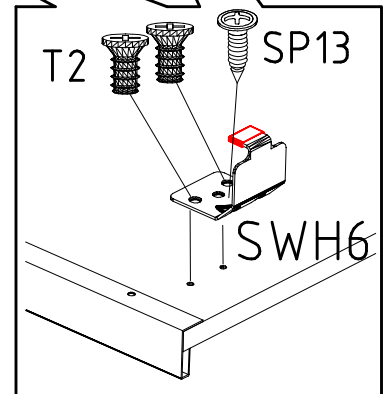

T2 T2 SP13

SWH6

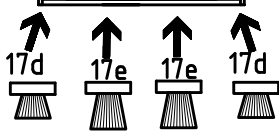
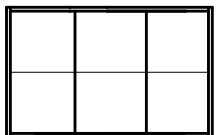

17d

17e

17e

17d



4

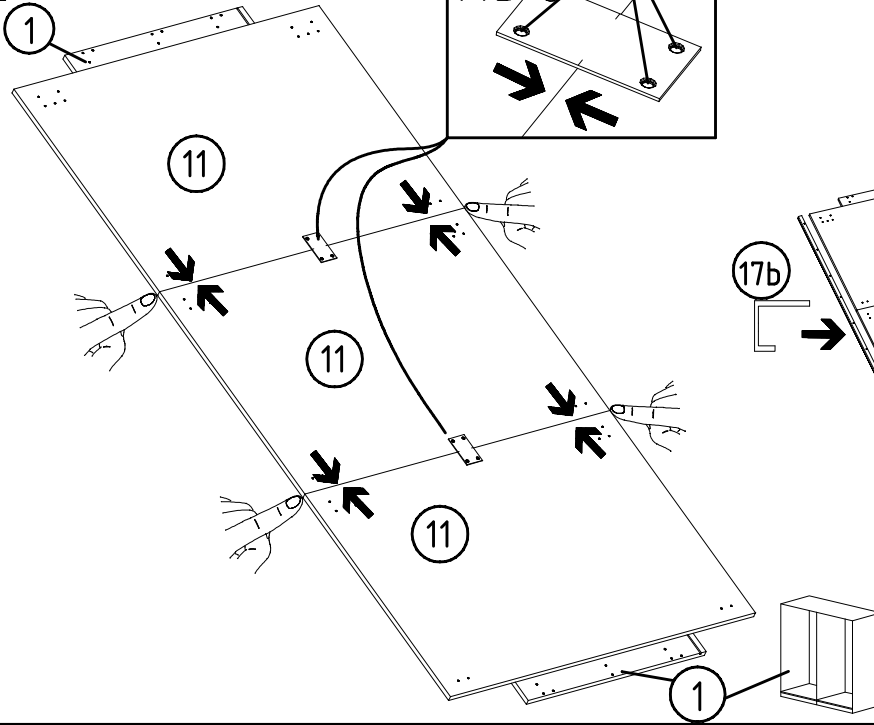
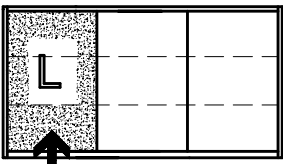

H5 4 X 13mm SP13

114 183 121 122

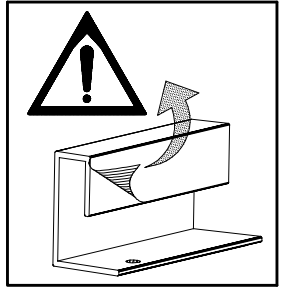

1x 17c 1x 17b

5

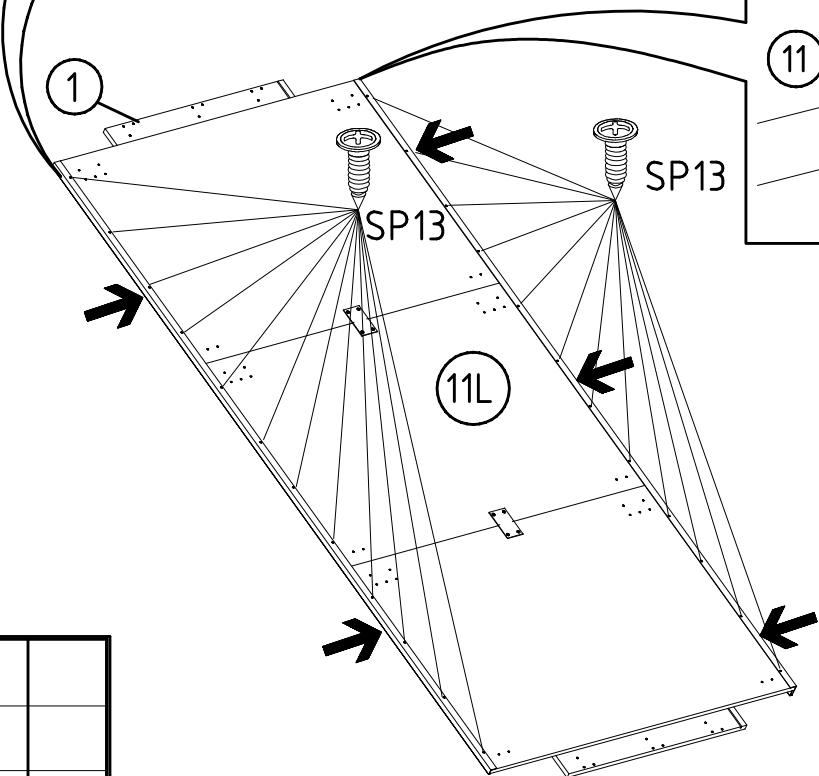
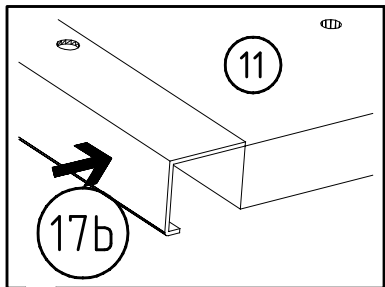

4 X 13mm SP13

121 122

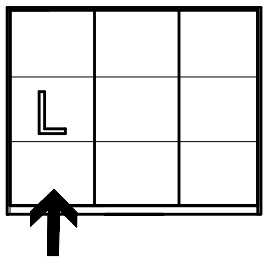
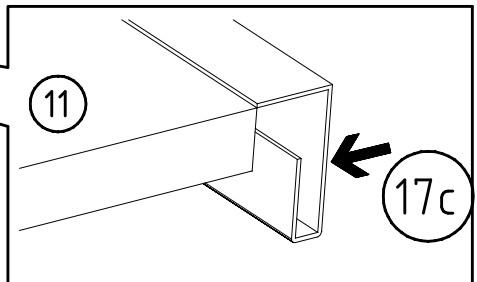

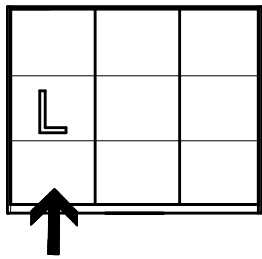
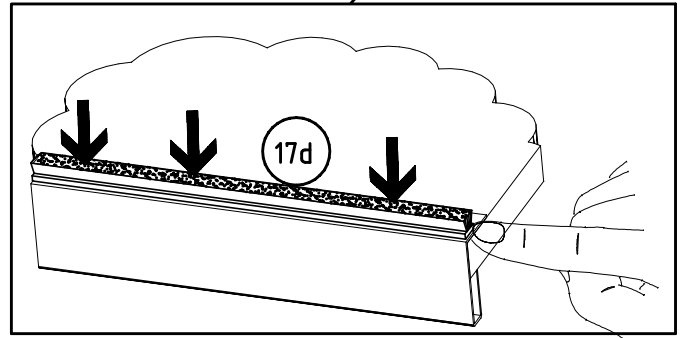
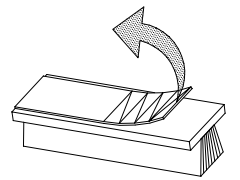
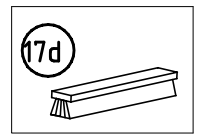
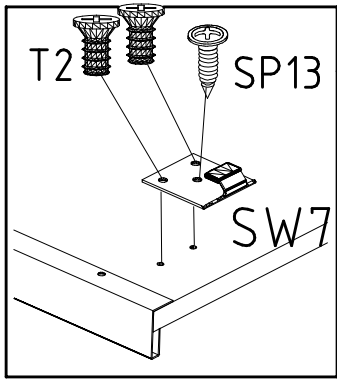
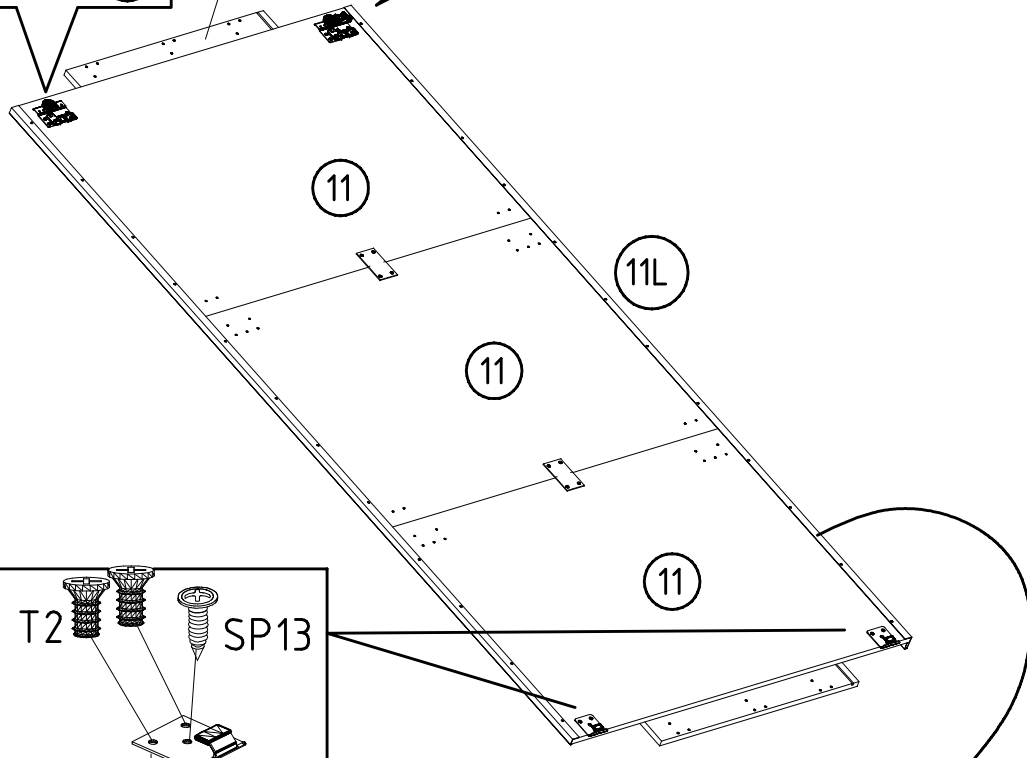
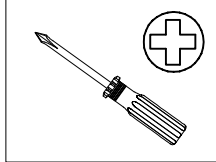
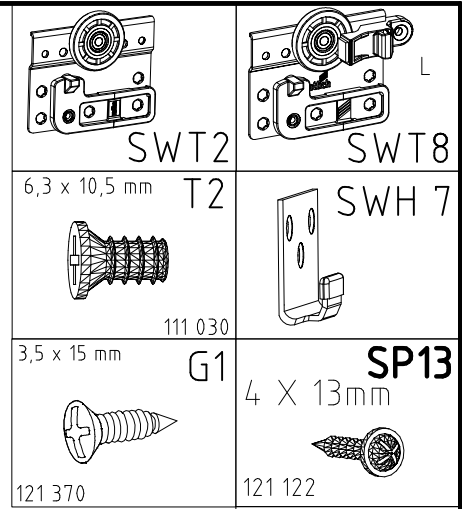
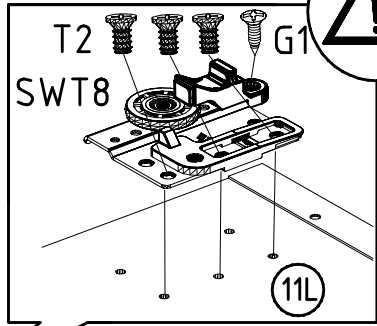
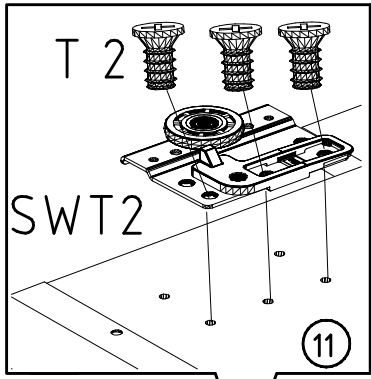

7

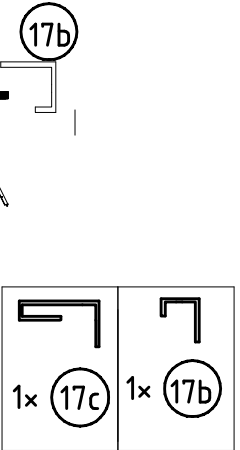
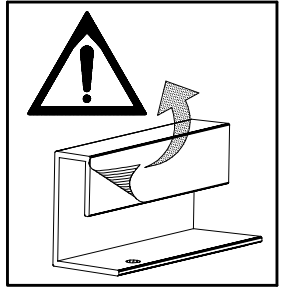
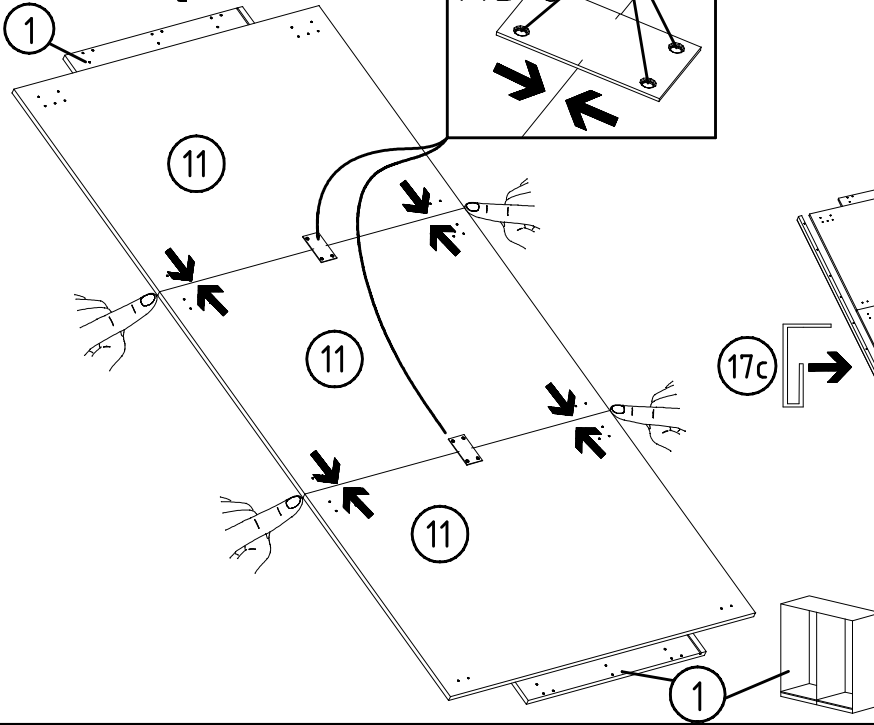
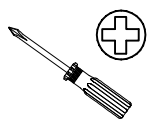
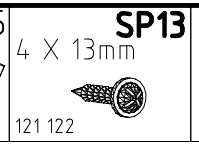
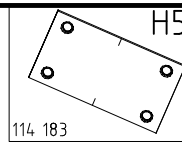
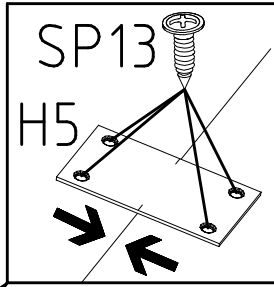
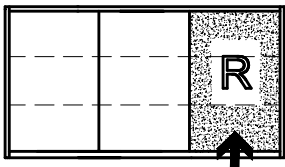

8

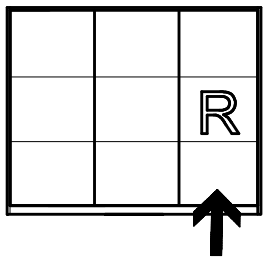
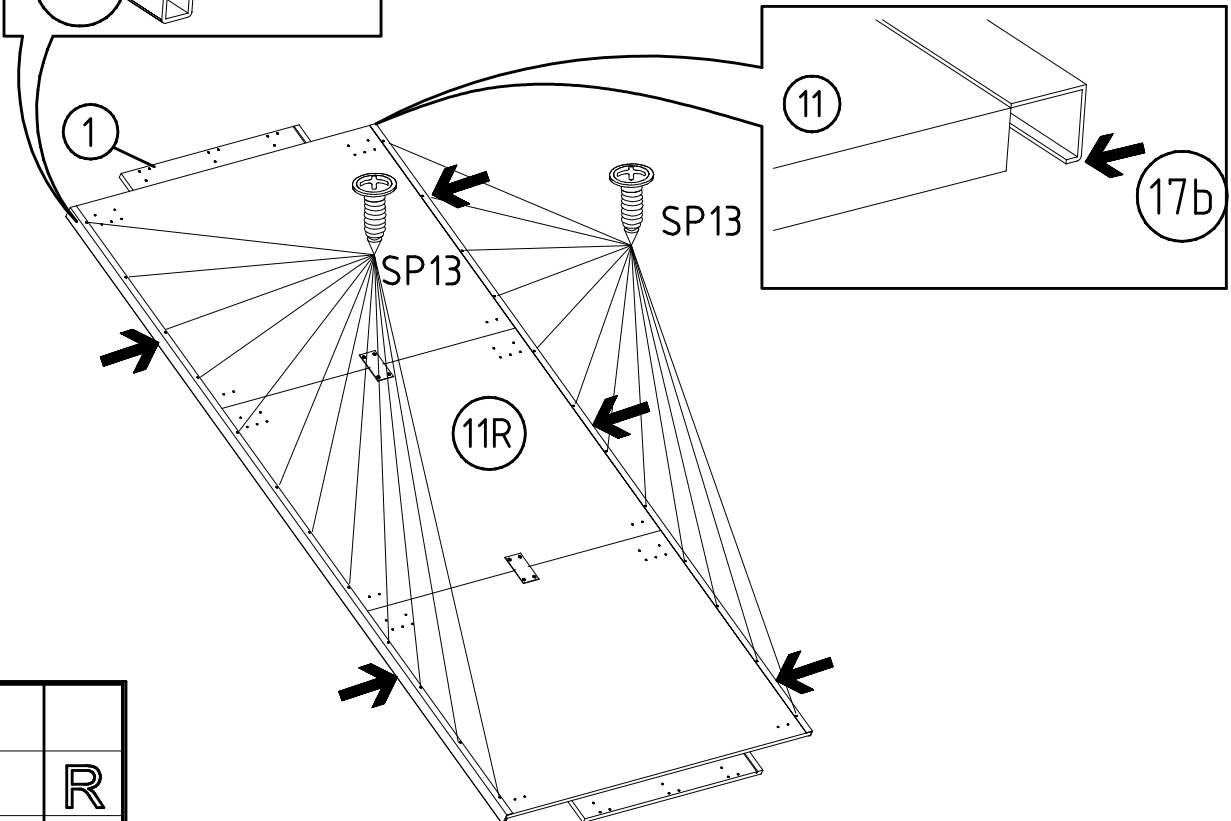
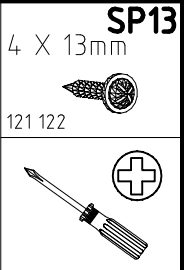
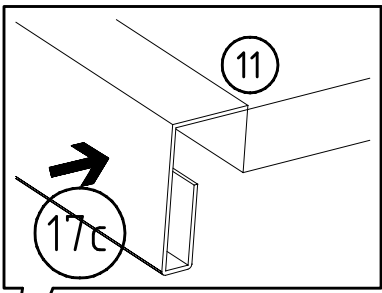

9

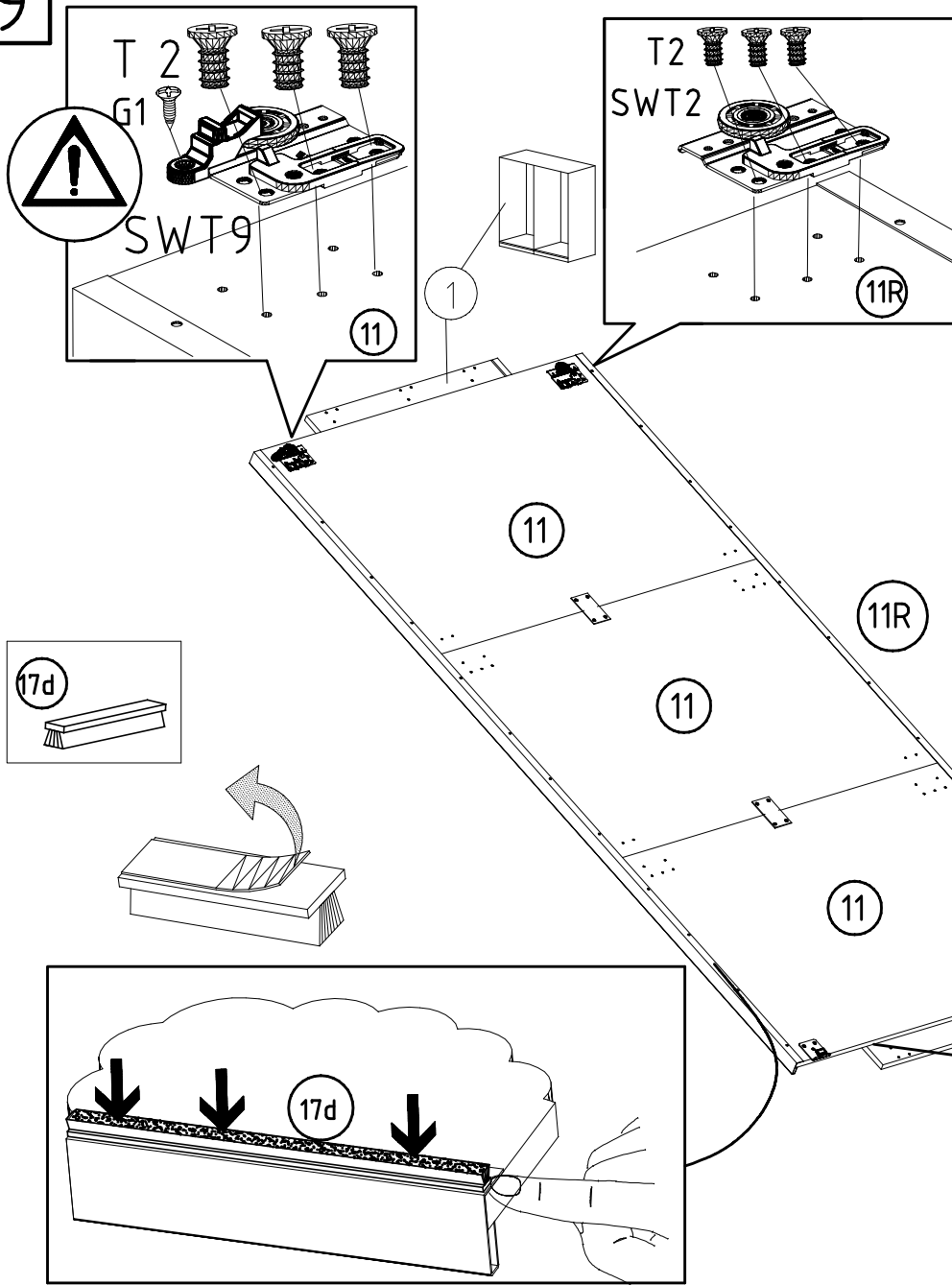

SWT2	SWT8
6,3 x 10,5 mm T2	SWH 7
111 030	
3,5 x 15 mm G1	SP13
	4 X 13mm
121 370	
	121 122

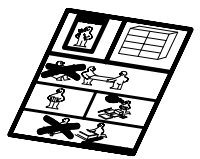
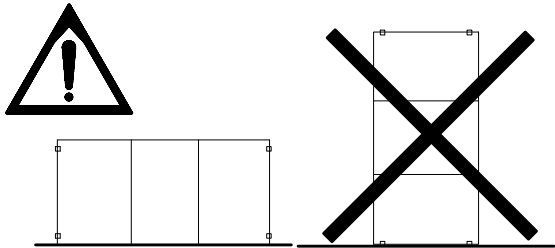
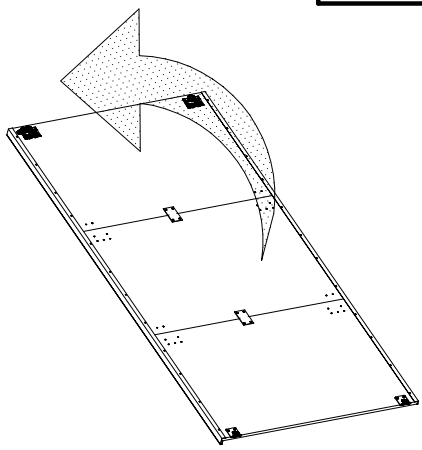
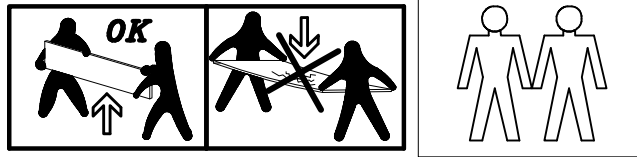
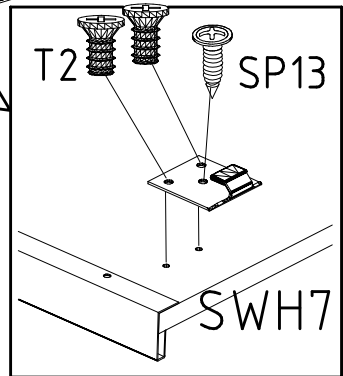
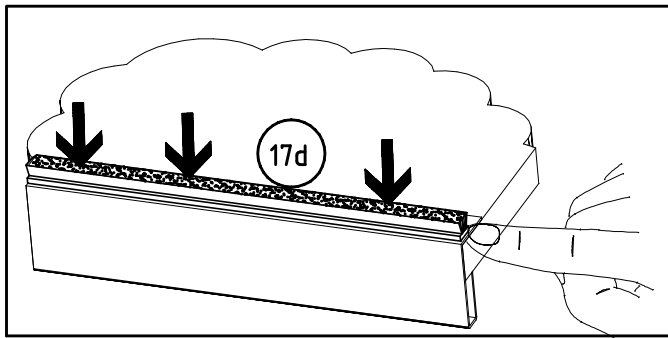
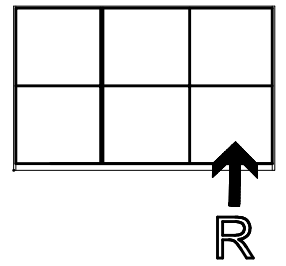
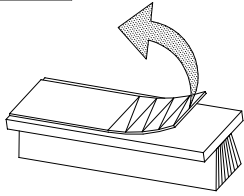
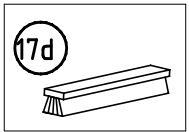

980832

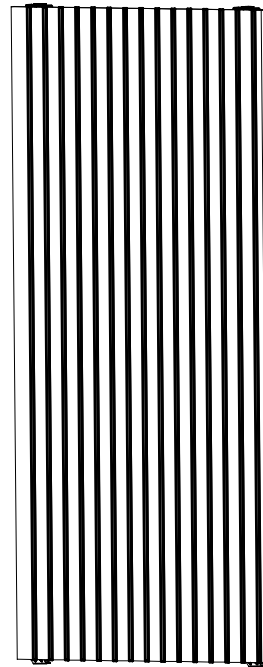
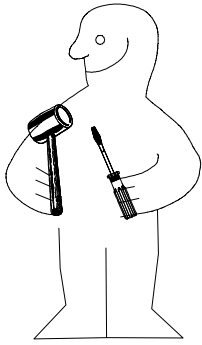

Frontenmontage

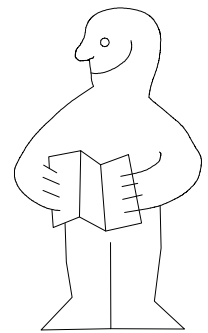
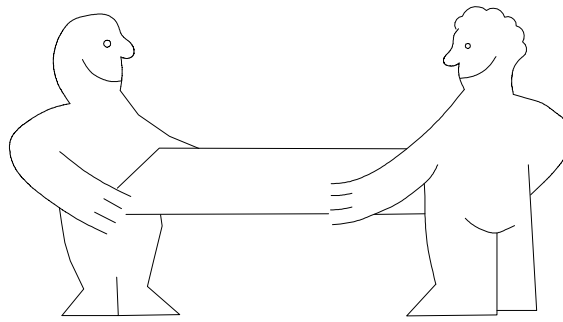
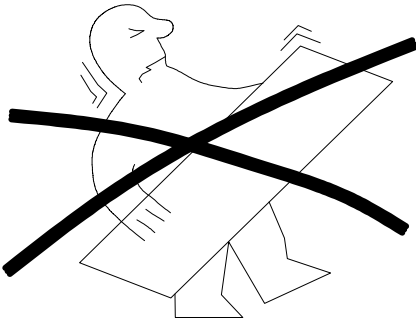

1-2-3-4... ○ ○

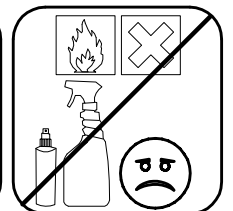
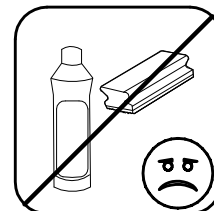
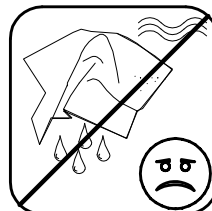
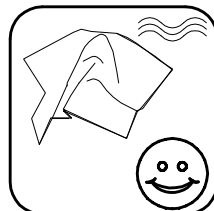
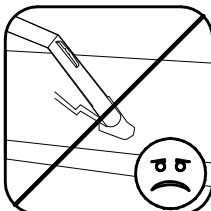
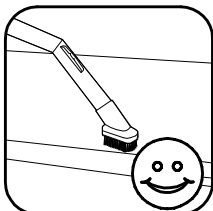
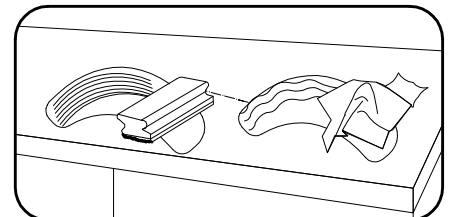
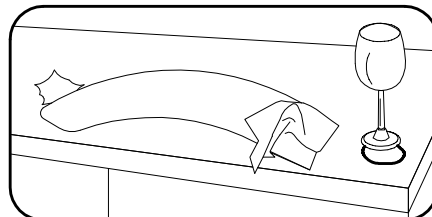
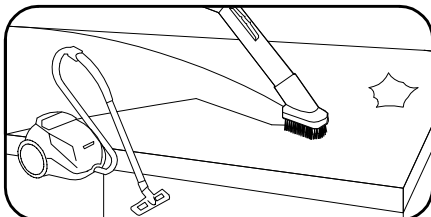
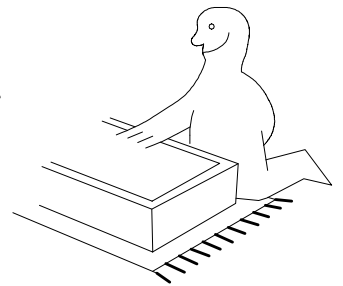
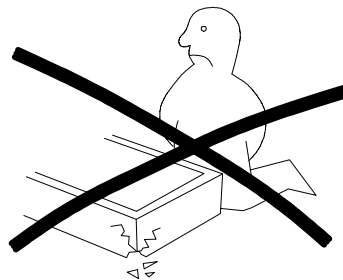
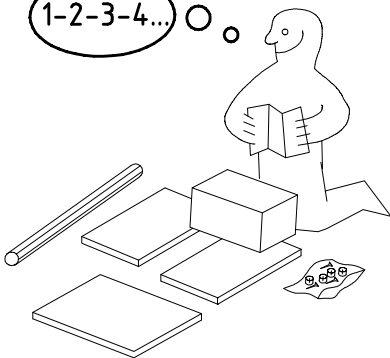

980832

08.02.23 / 01.07.23

07 23

1/4

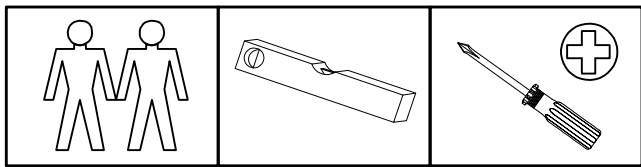

4 X 13mm **SP13**  
121 122

32x

**SWH 6**  
2x

**SW-AK**  
2x

**SWT 1**  
2x

6,3 x 10,5 mm **T2**  
111 030  
14x

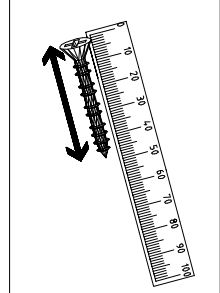
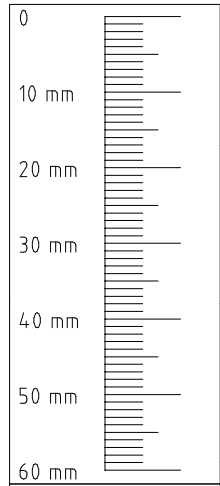

2x (17c)



2x (17e)

(17e)

(17c)

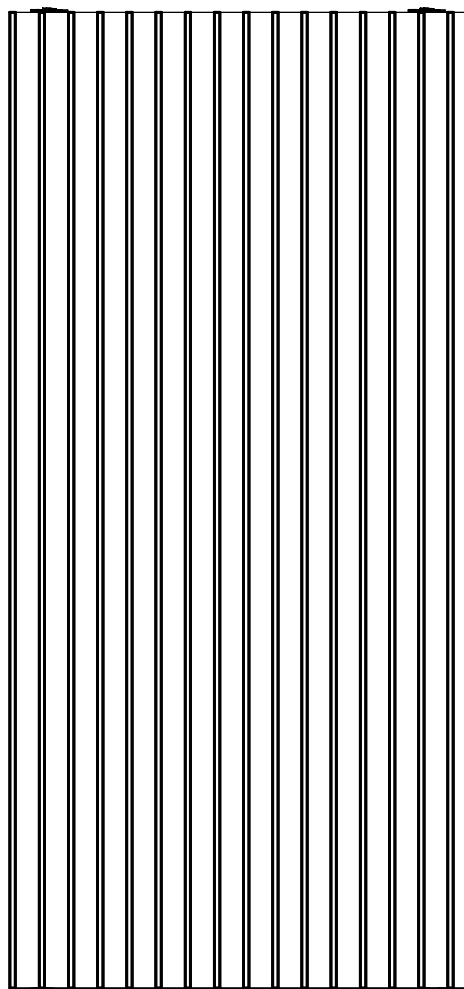
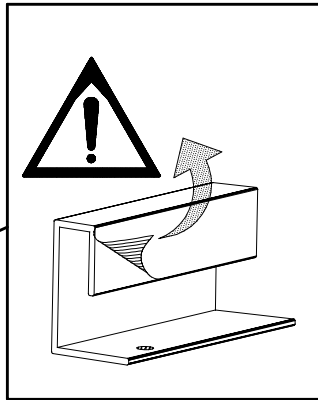

2124 / 2316 x 990 x 15

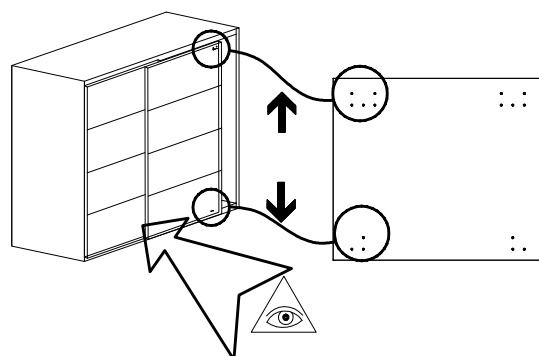

1

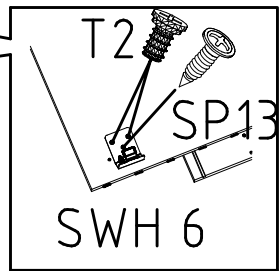
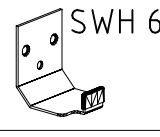
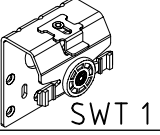
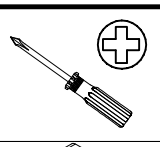
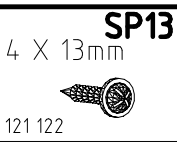
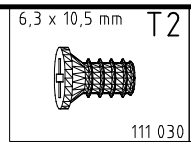
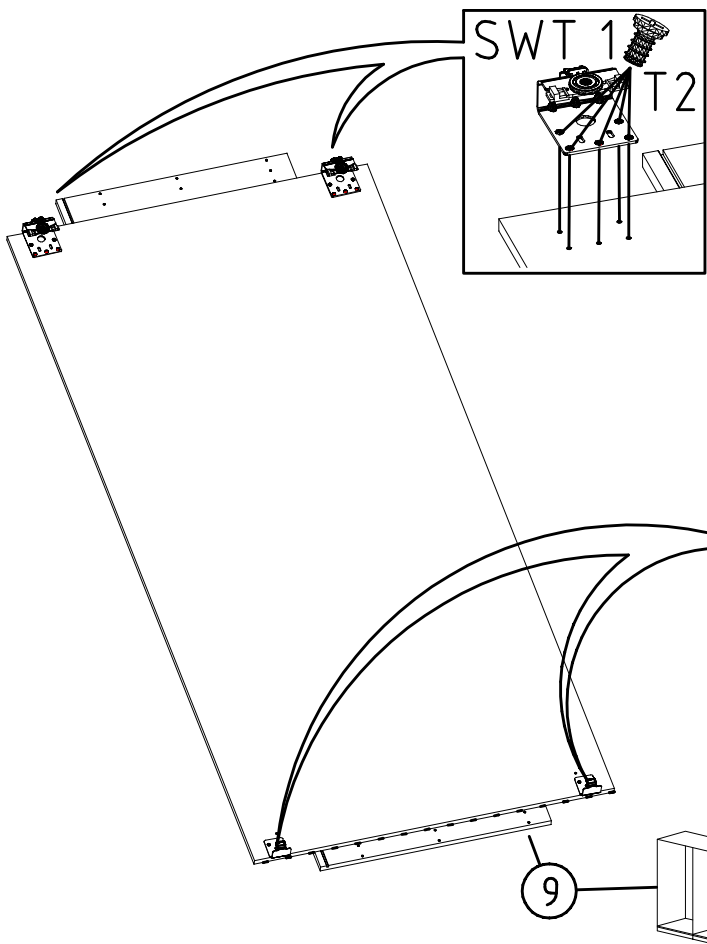

9

2

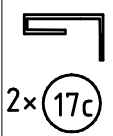
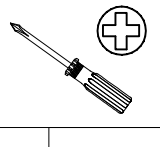
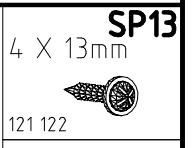
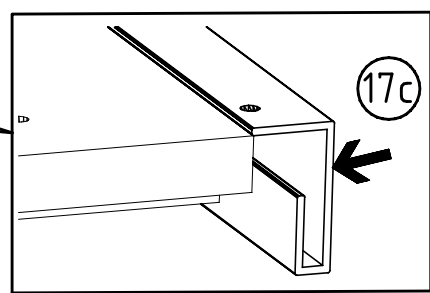
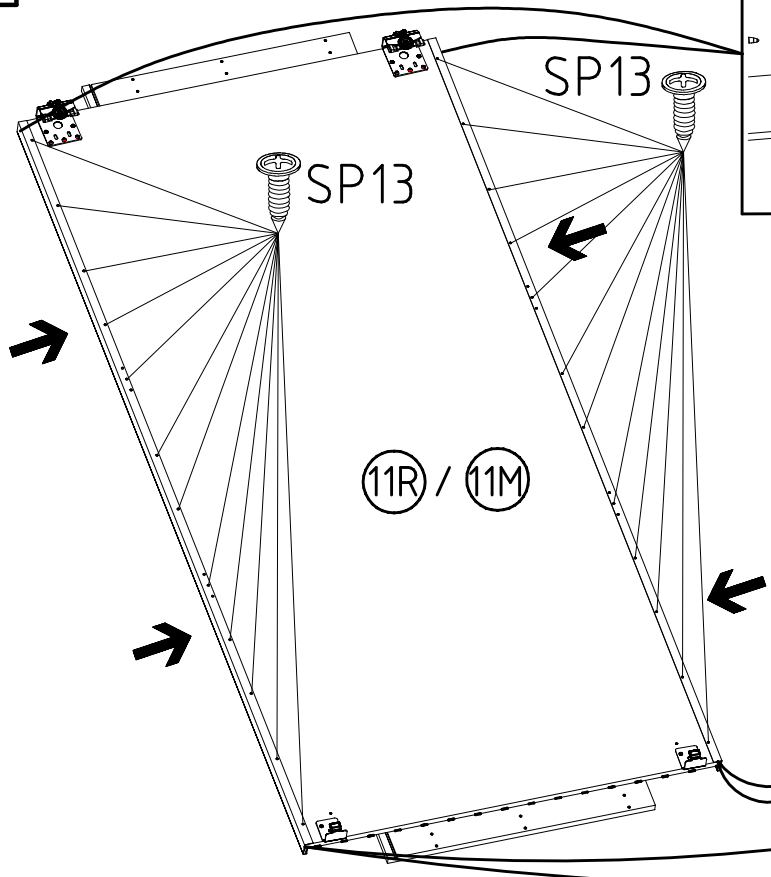

11R / 11M

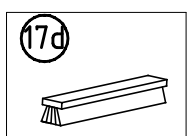
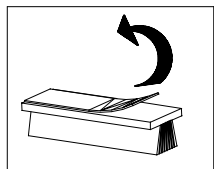
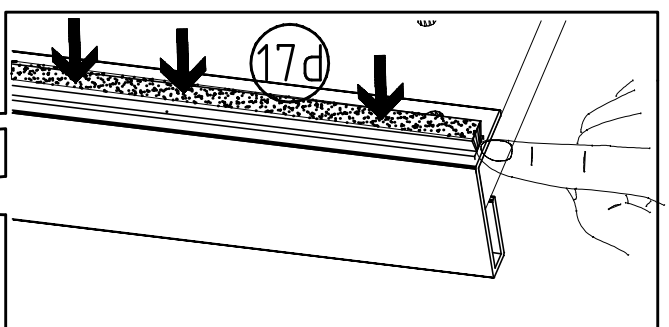

3

SW-AK

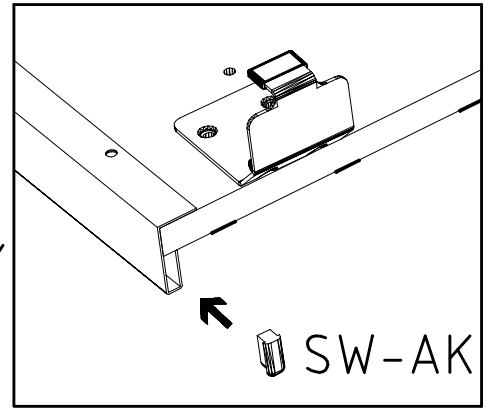
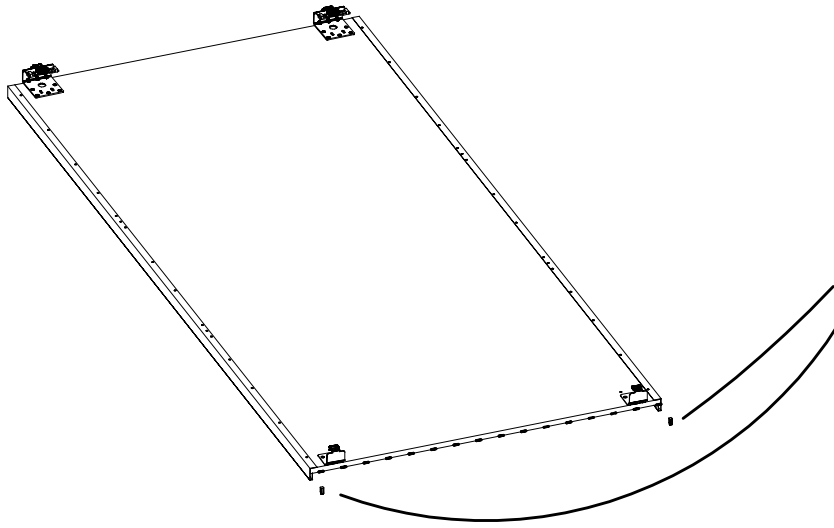

4

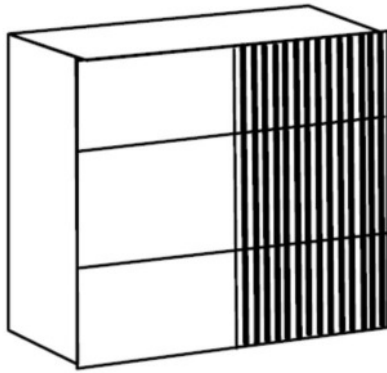

11R

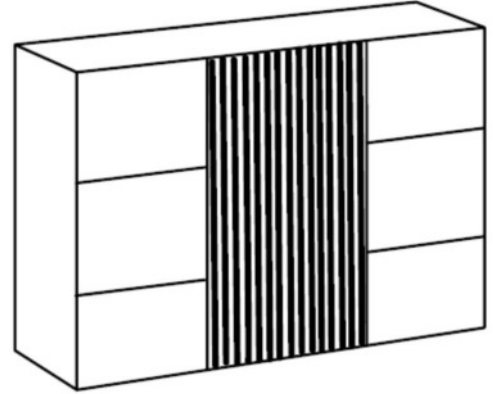

11M

5

