

Nature One 22 18 FF 02

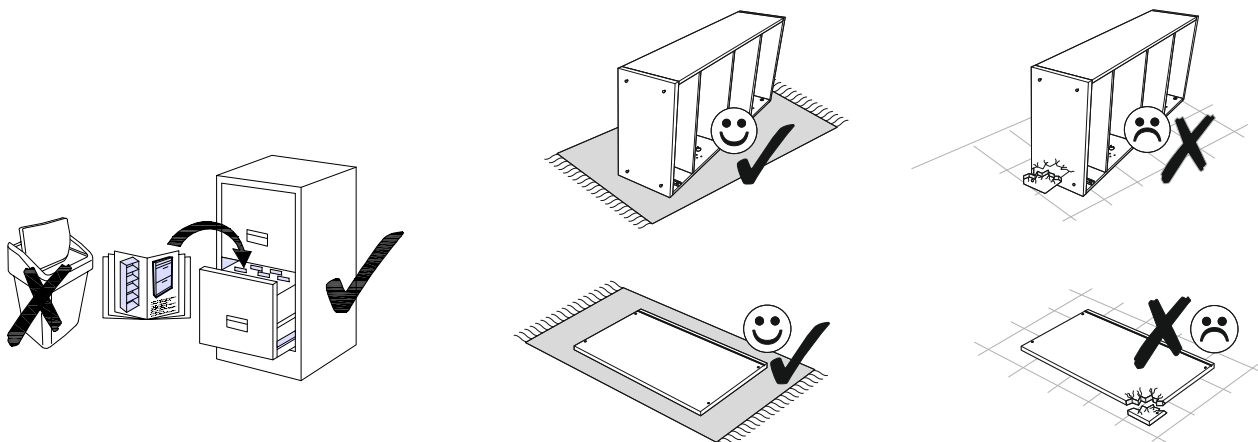

Nature One 22 18 FF 02

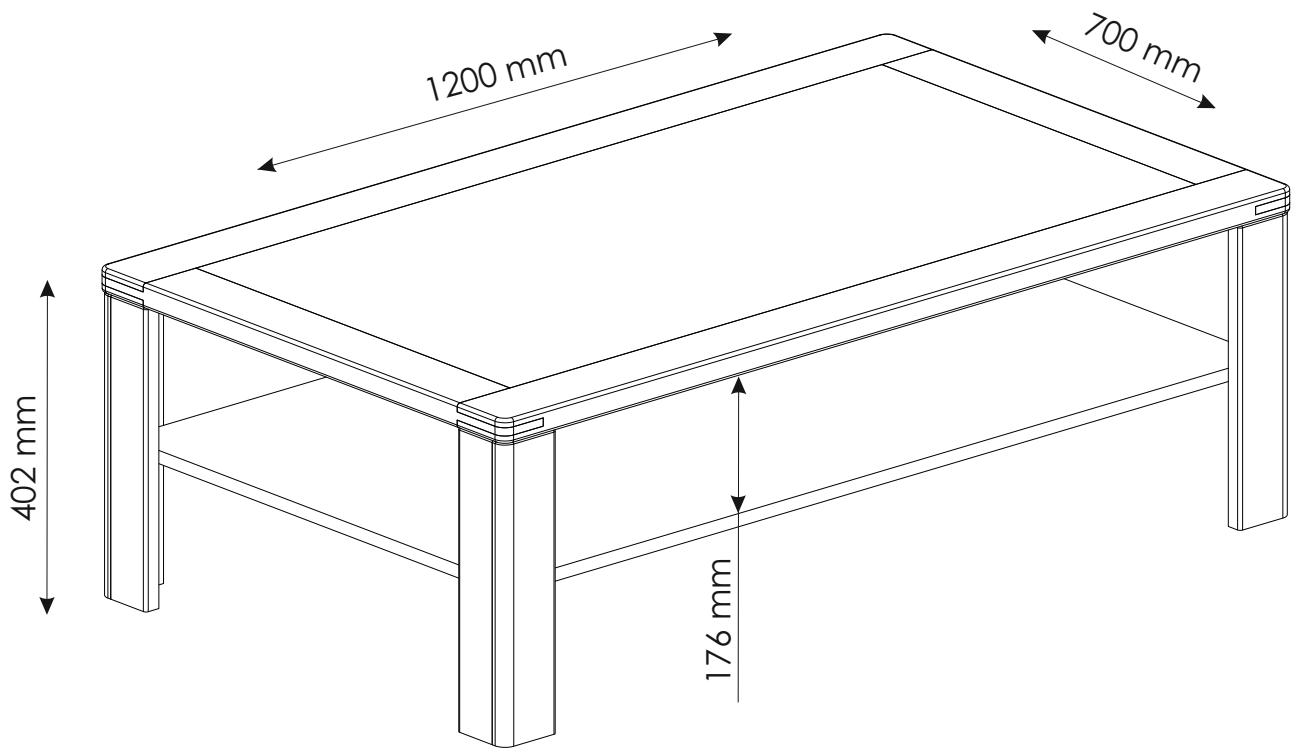
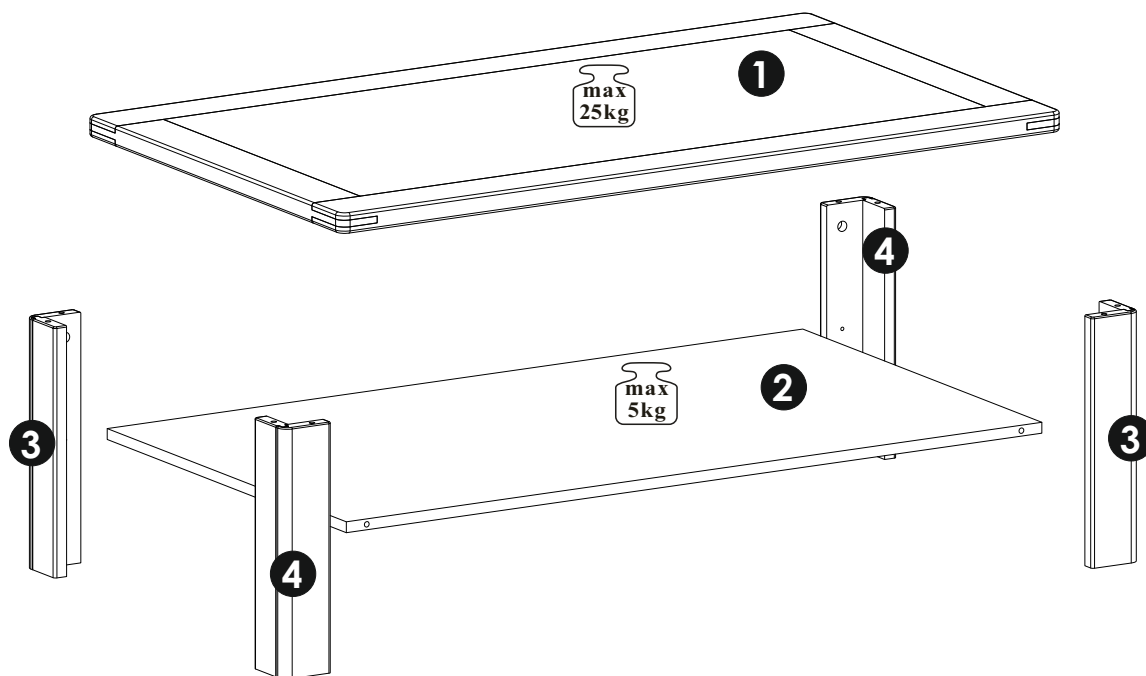
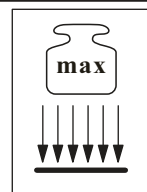

30 min

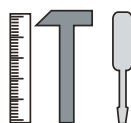

NO	Dim.(mm)			Col.-No	Qty
1	1200	700	20	1/1	1
2	1156	656	16	1/1	1
3	367	80x80	20	1/1	2
4	367	80x80	20	1/1	2
A				1/1	1

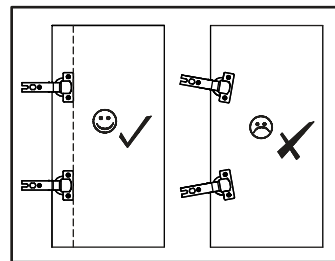
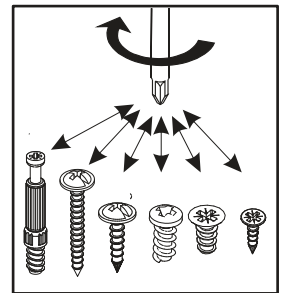
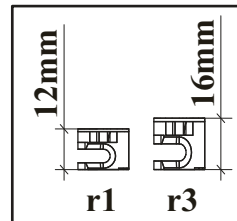
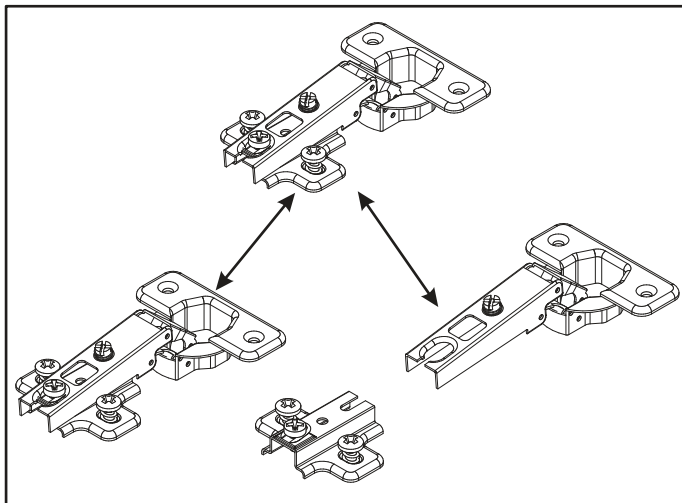
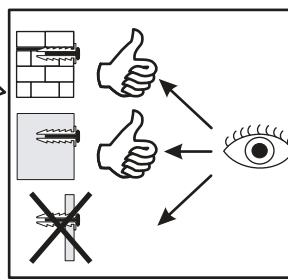
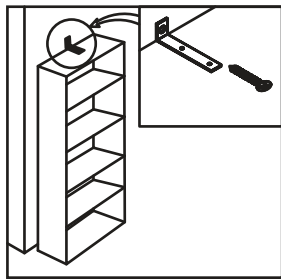
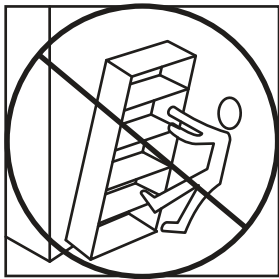
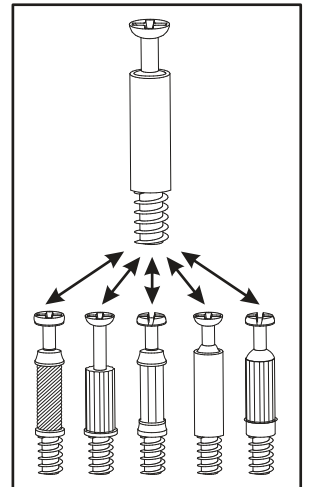
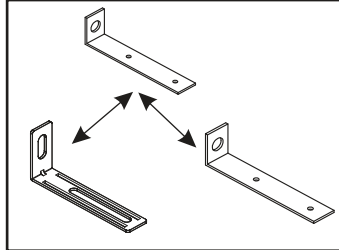
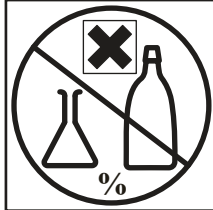
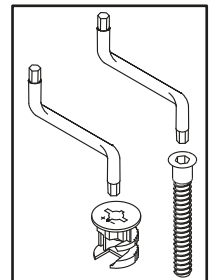
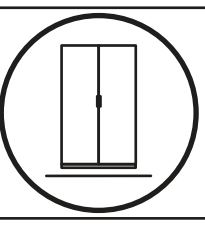
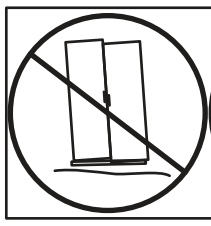
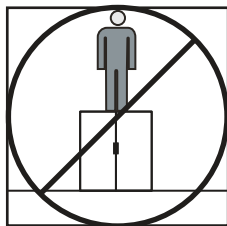
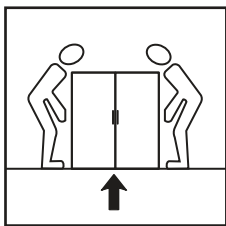
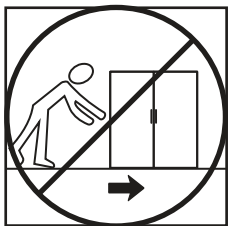
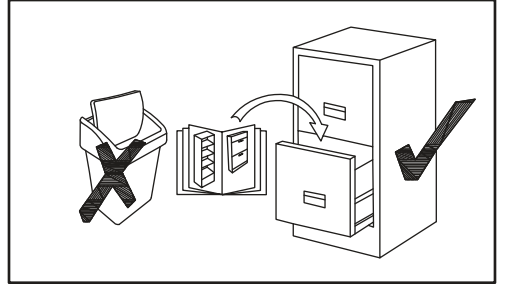
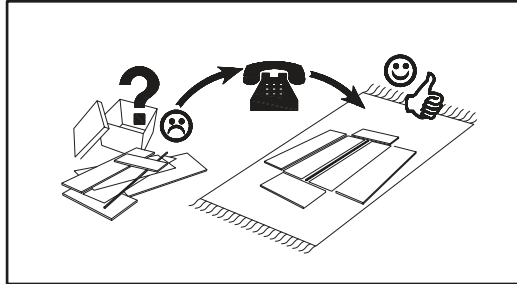
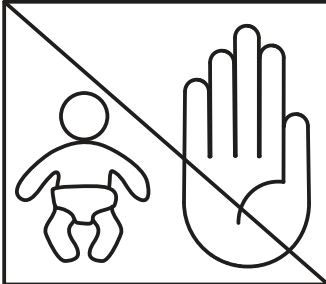
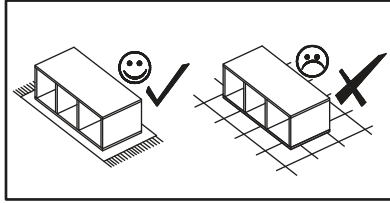
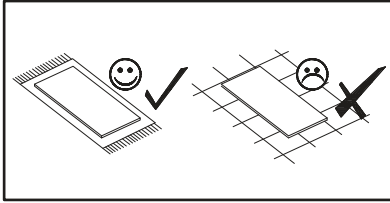
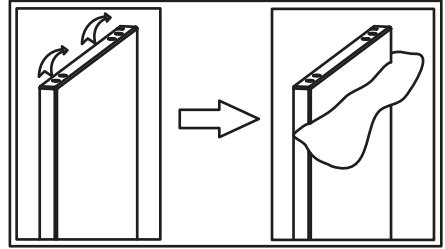

A1

