

A**S643-REGN/110/40****CONNECT**

24270215/11
24270215/12

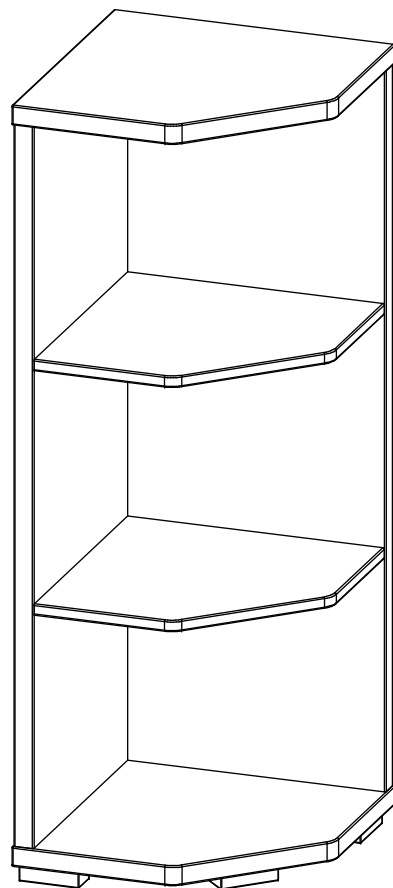

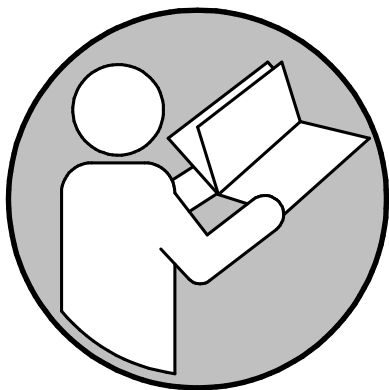
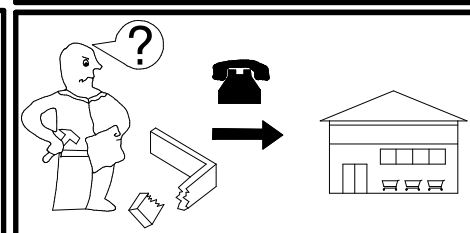
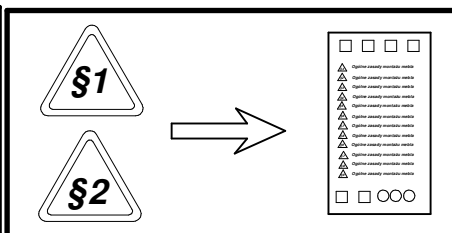
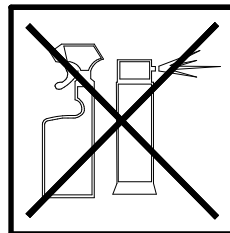
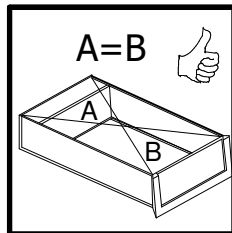
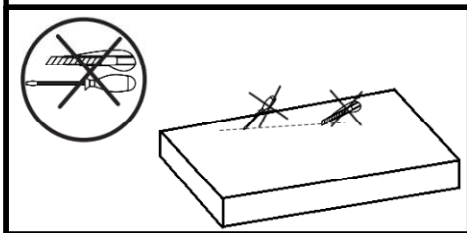
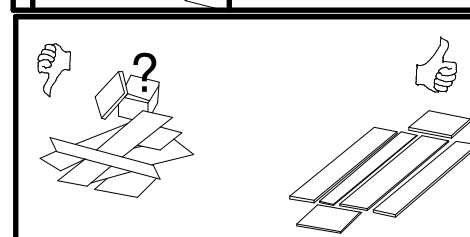
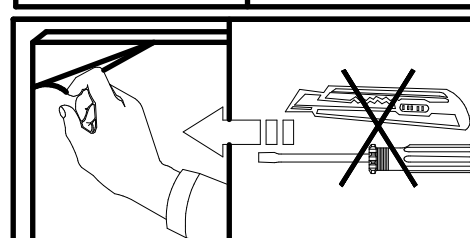
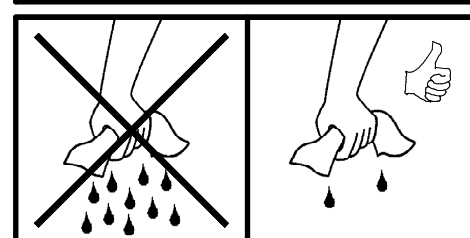
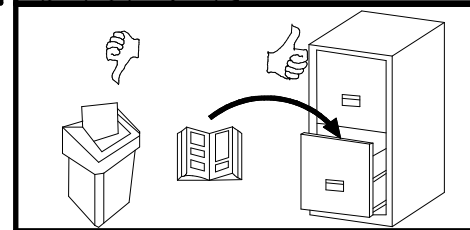
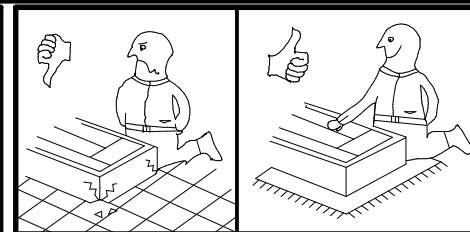
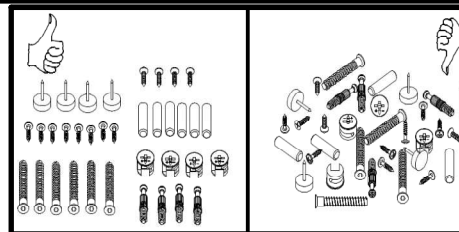
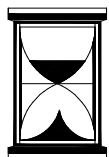
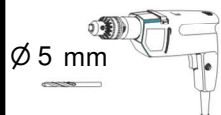
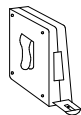
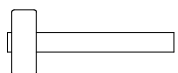
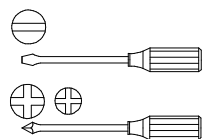
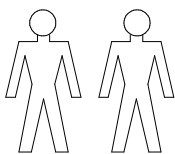

35 min

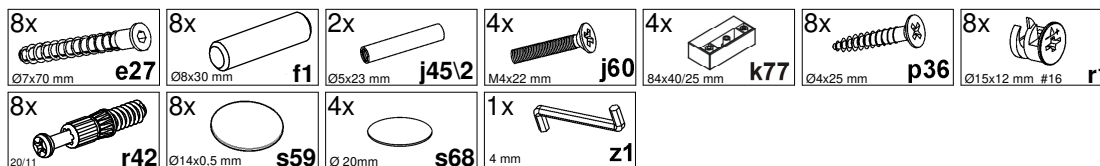

| A | B1 | B2 | C1 | C2 | C3 | D |
|---|-----------|----|------|-----|----|-----|
| 1 | S643-1007 | - | 1016 | 393 | 28 | 1/1 |
| 2 | S643-1008 | - | 1016 | 363 | 28 | 1/1 |
| 3 | S643-2007 | - | 395 | 395 | 28 | 1/1 |
| 4 | S643-2008 | - | 395 | 395 | 28 | 1/1 |
| 5 | S643-3003 | - | 361 | 363 | 16 | 1/1 |

A

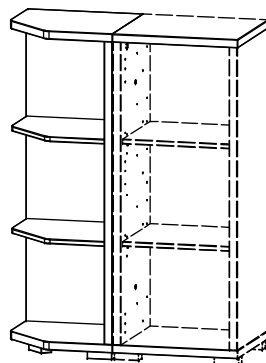

B

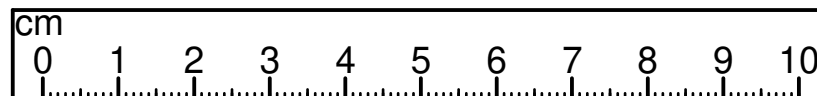
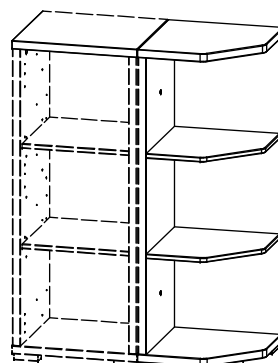

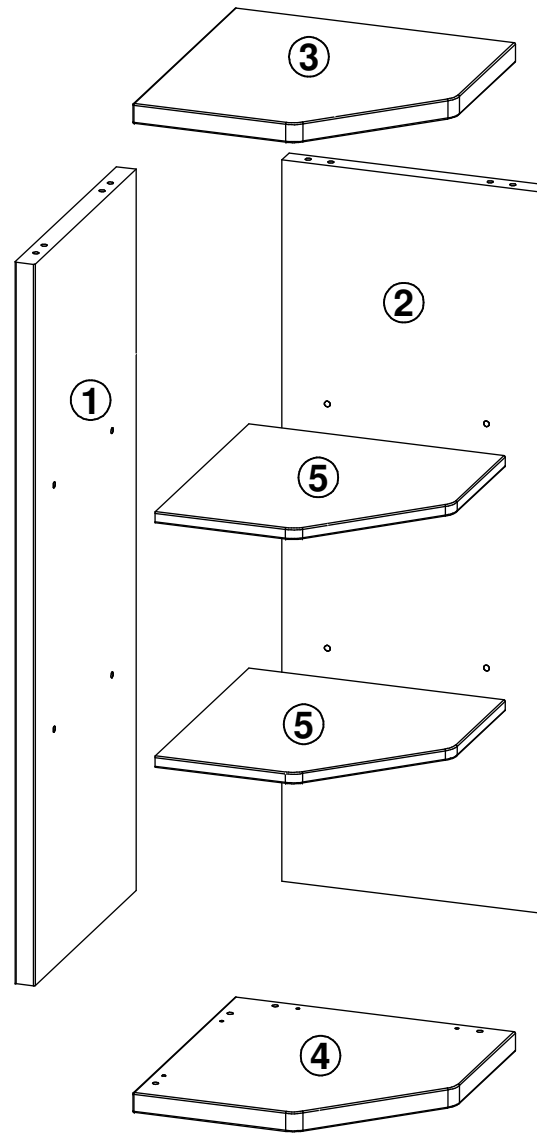

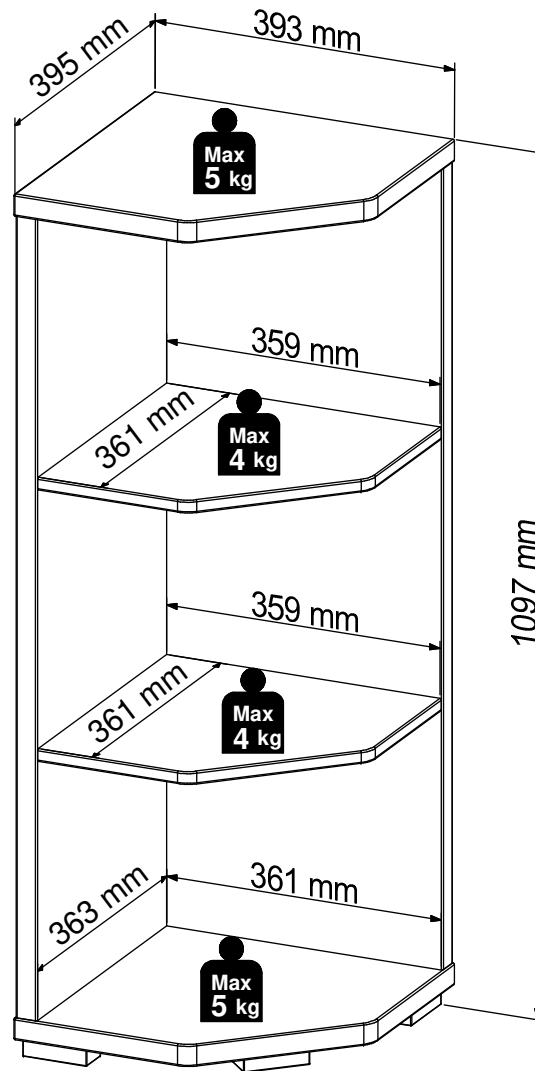

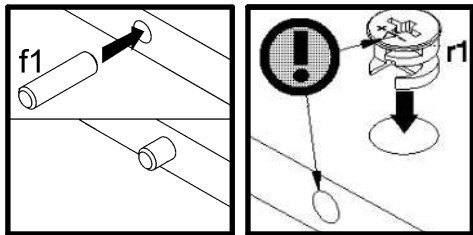
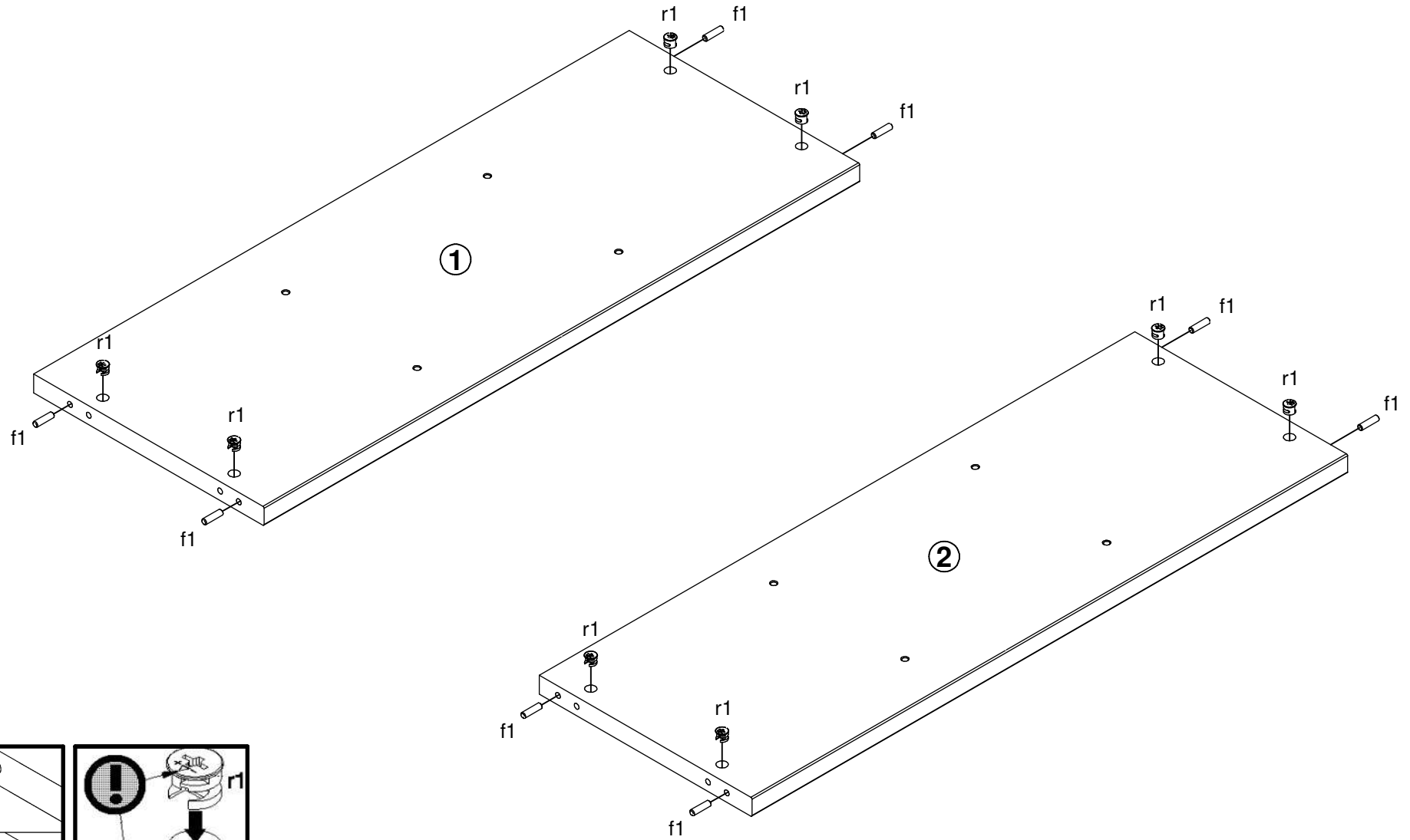
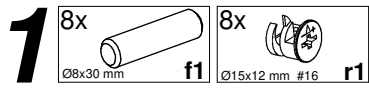

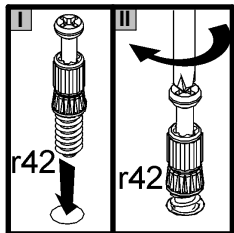
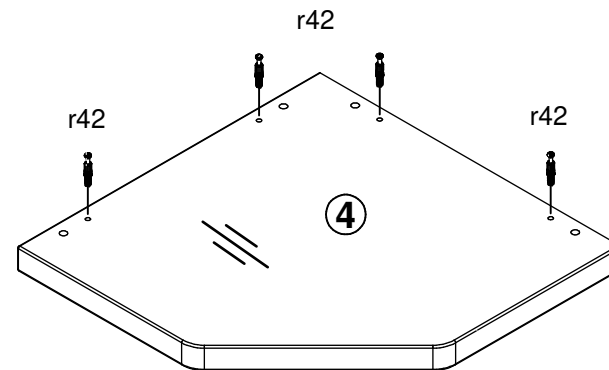
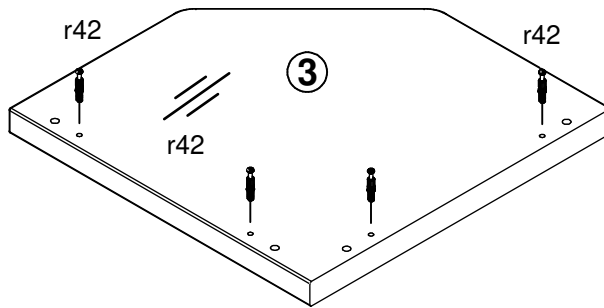
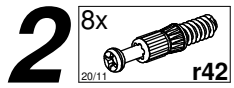

3

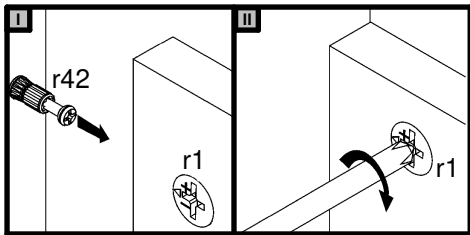
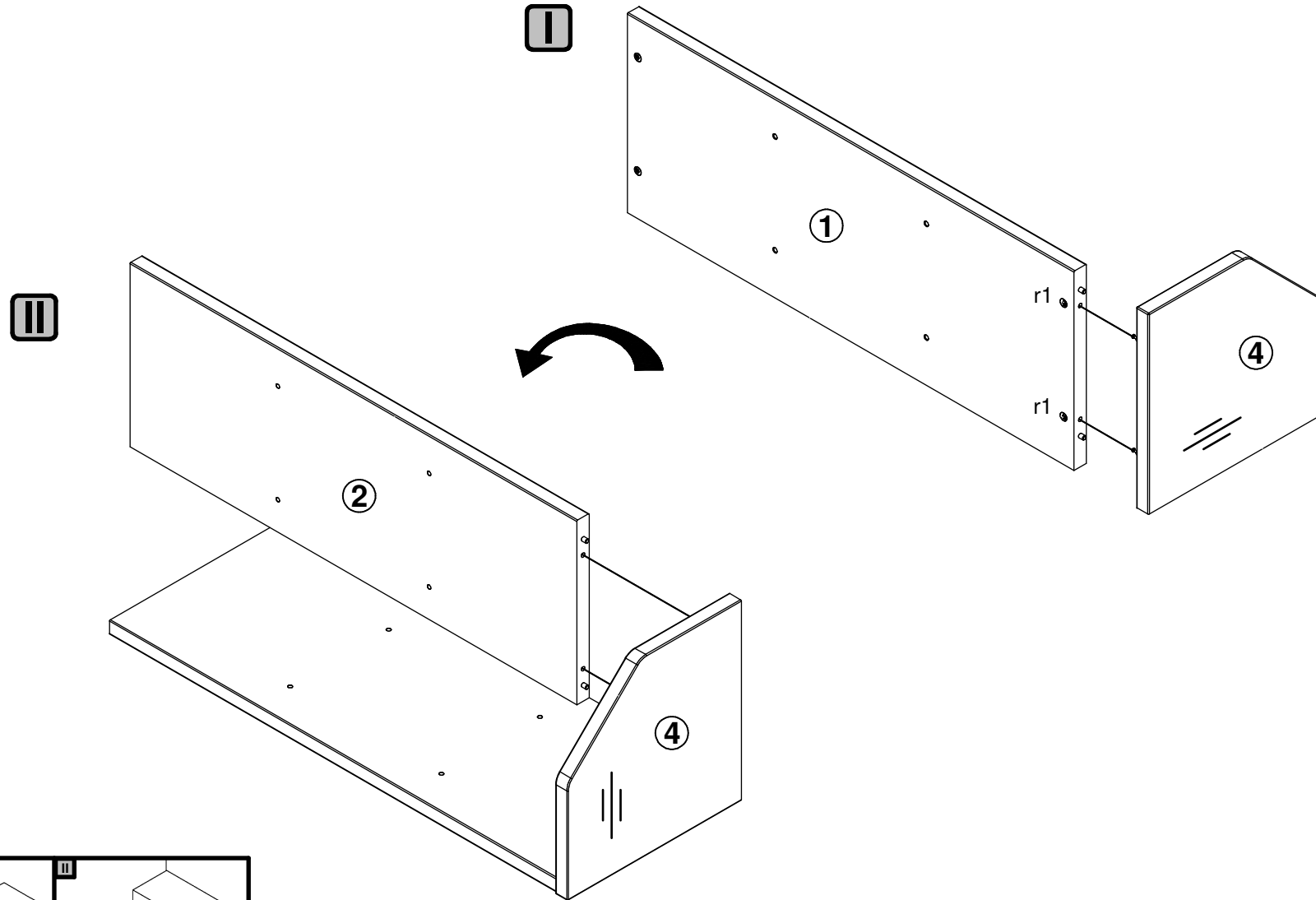

4

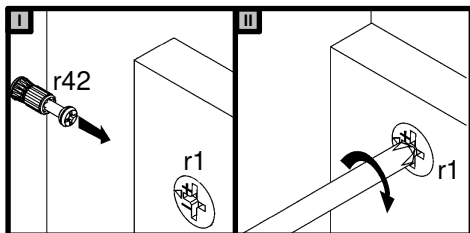
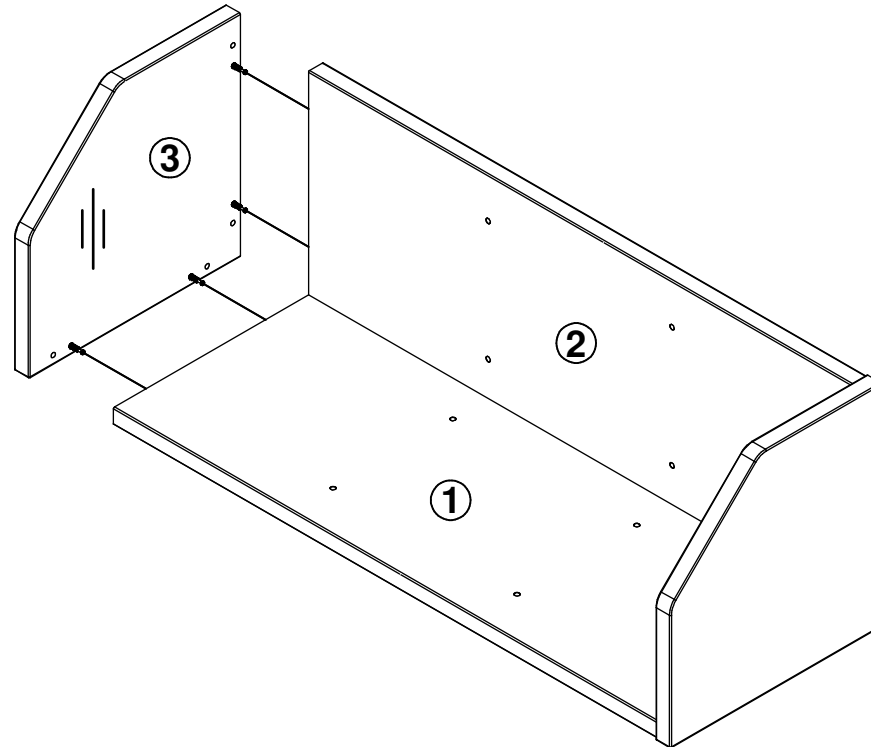

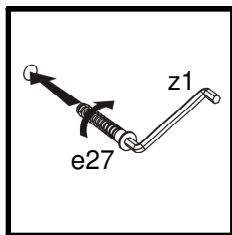
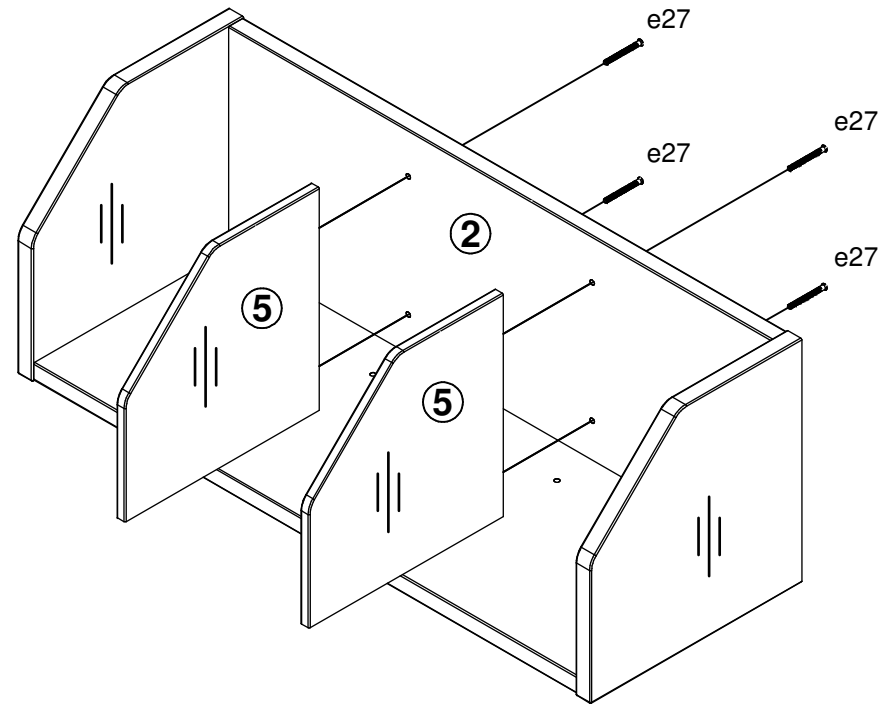
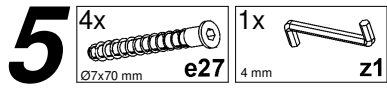

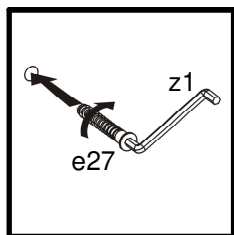
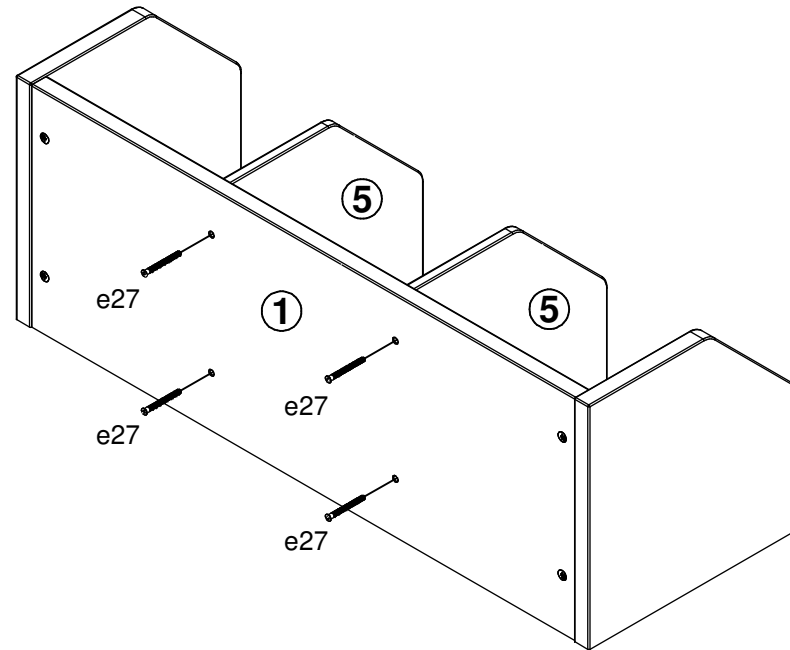
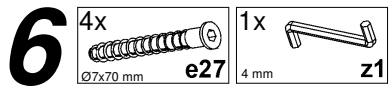

7A

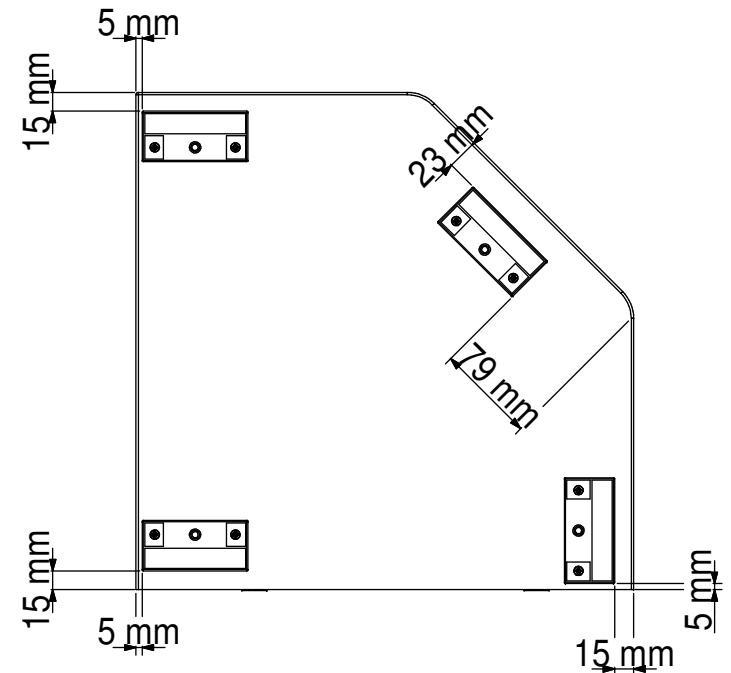
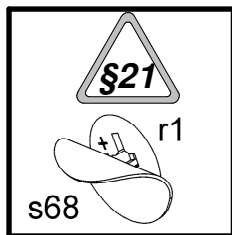
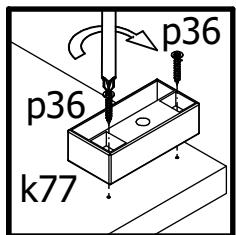
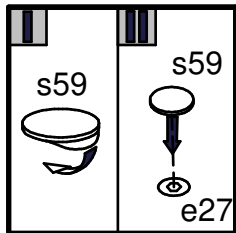
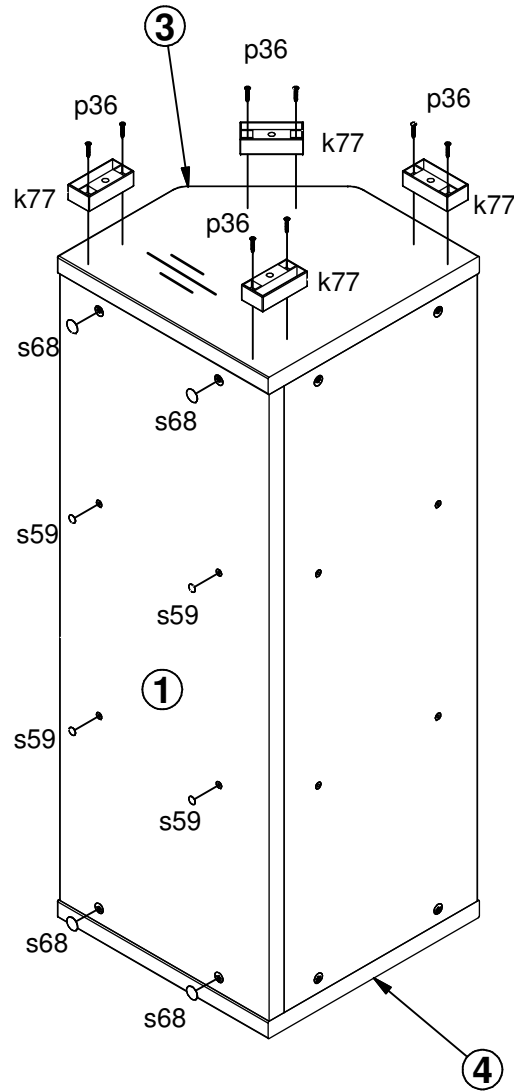
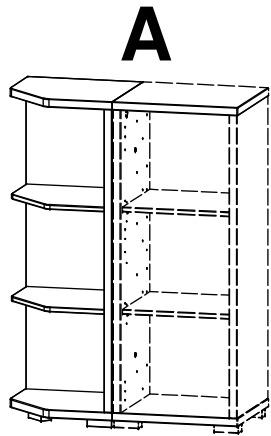
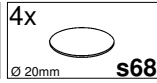
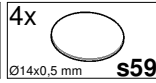
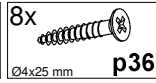
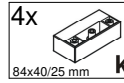

8A

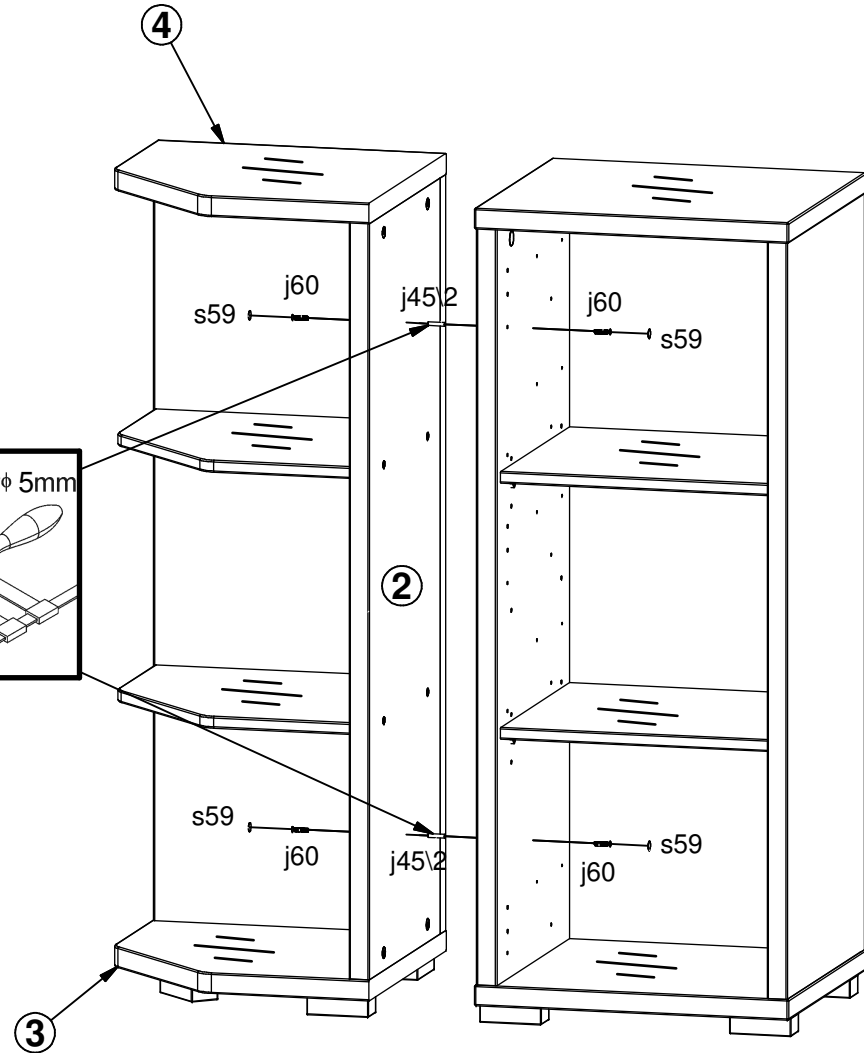
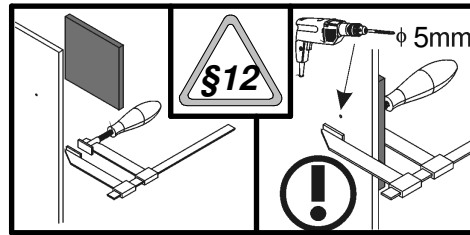
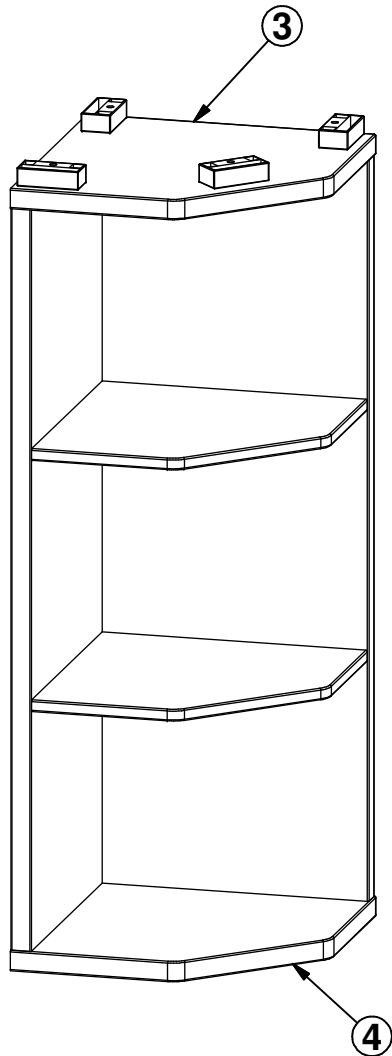
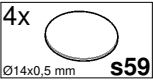
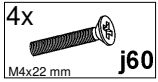
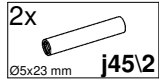

7B

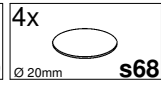
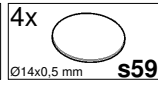
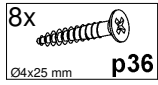
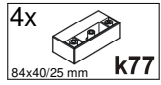

B

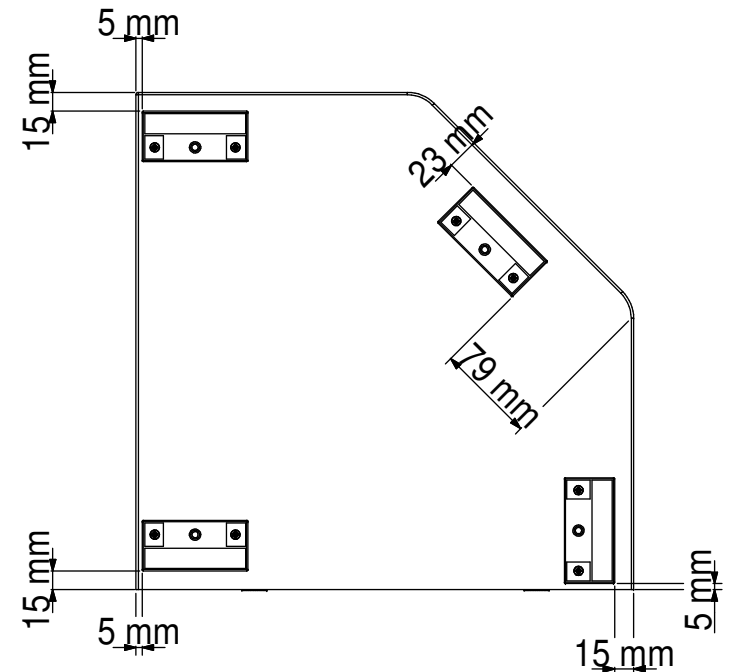
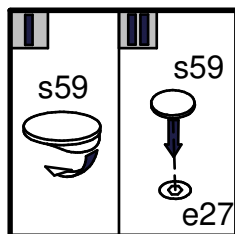
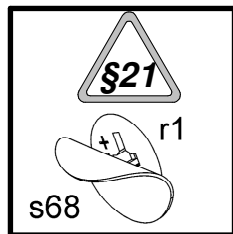
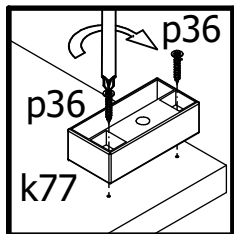
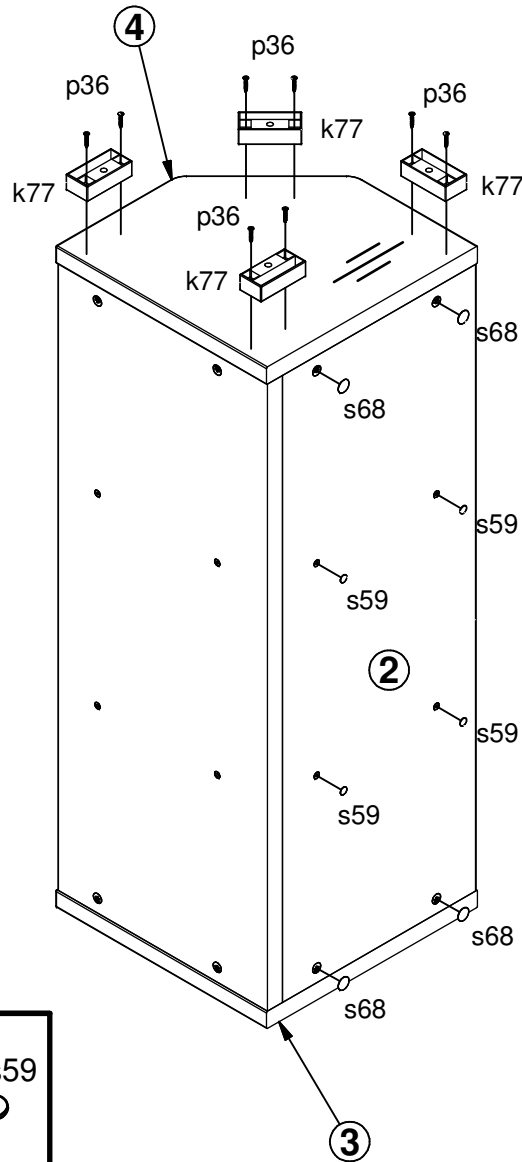
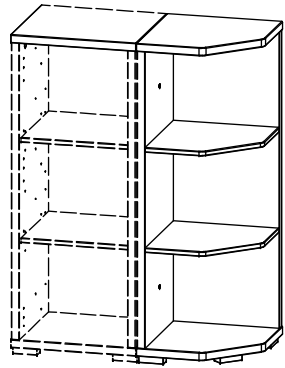

8B

