

A**S643-FRN/205/80/A****CONNECT**

24270215/21
24270215/22

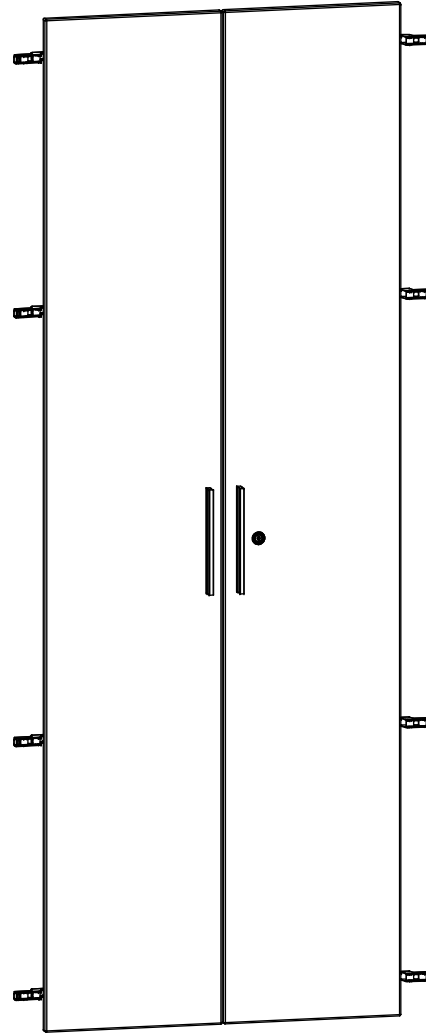

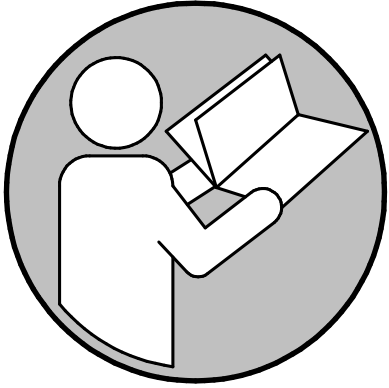
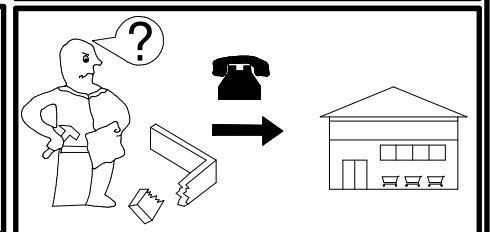
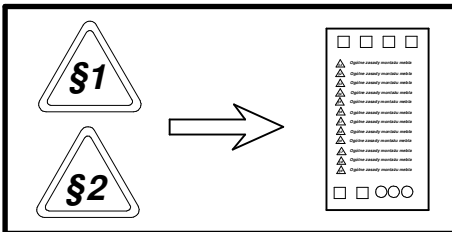
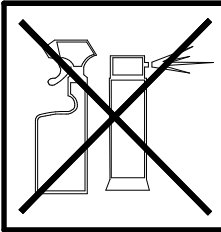
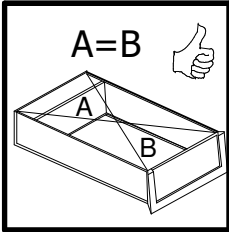
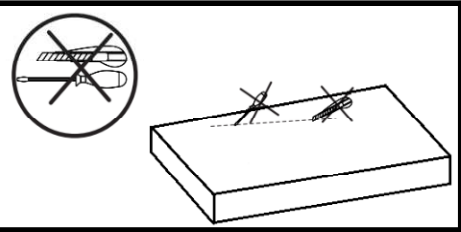
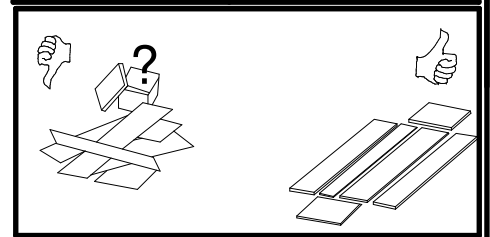
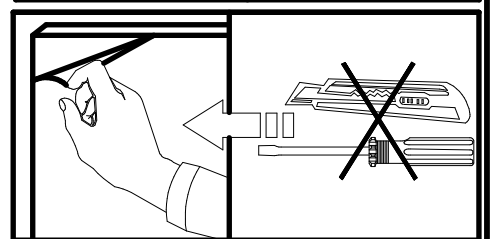
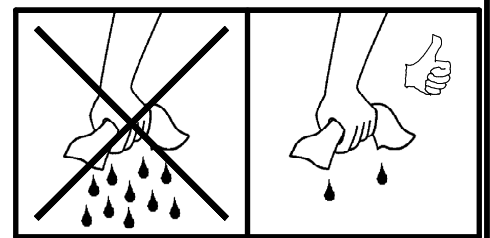
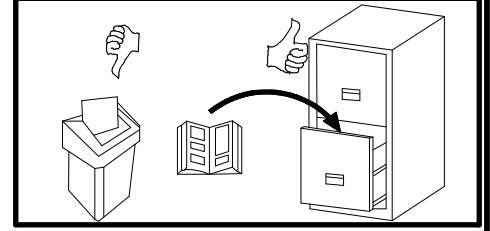
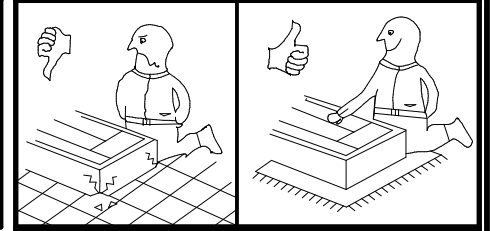
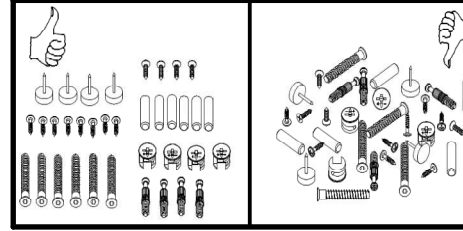
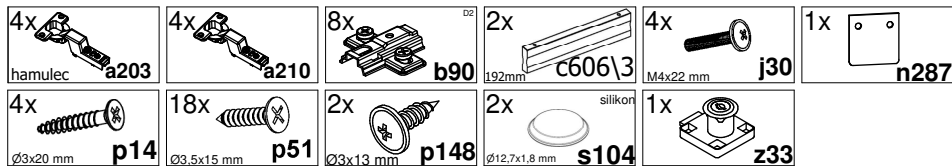
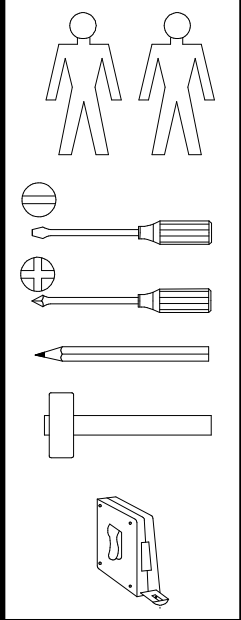

A	B1	B2	C1	C2	C3	D
1	S643-0002	-	2042	364	16	1/1
2	S643-0003	-	2042	364	16	1/1

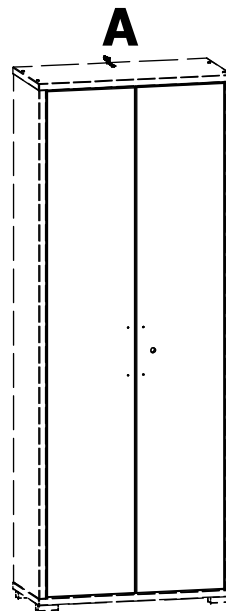

S643-REG/213/80

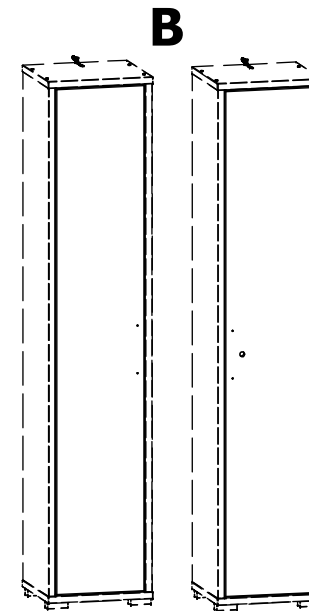

S643-REG/213/43



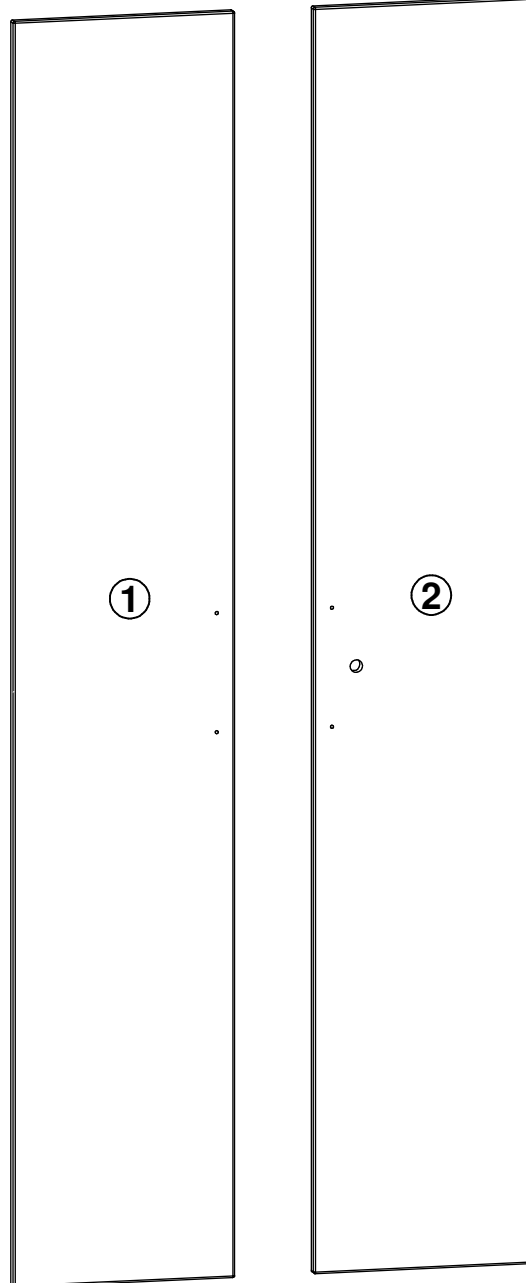

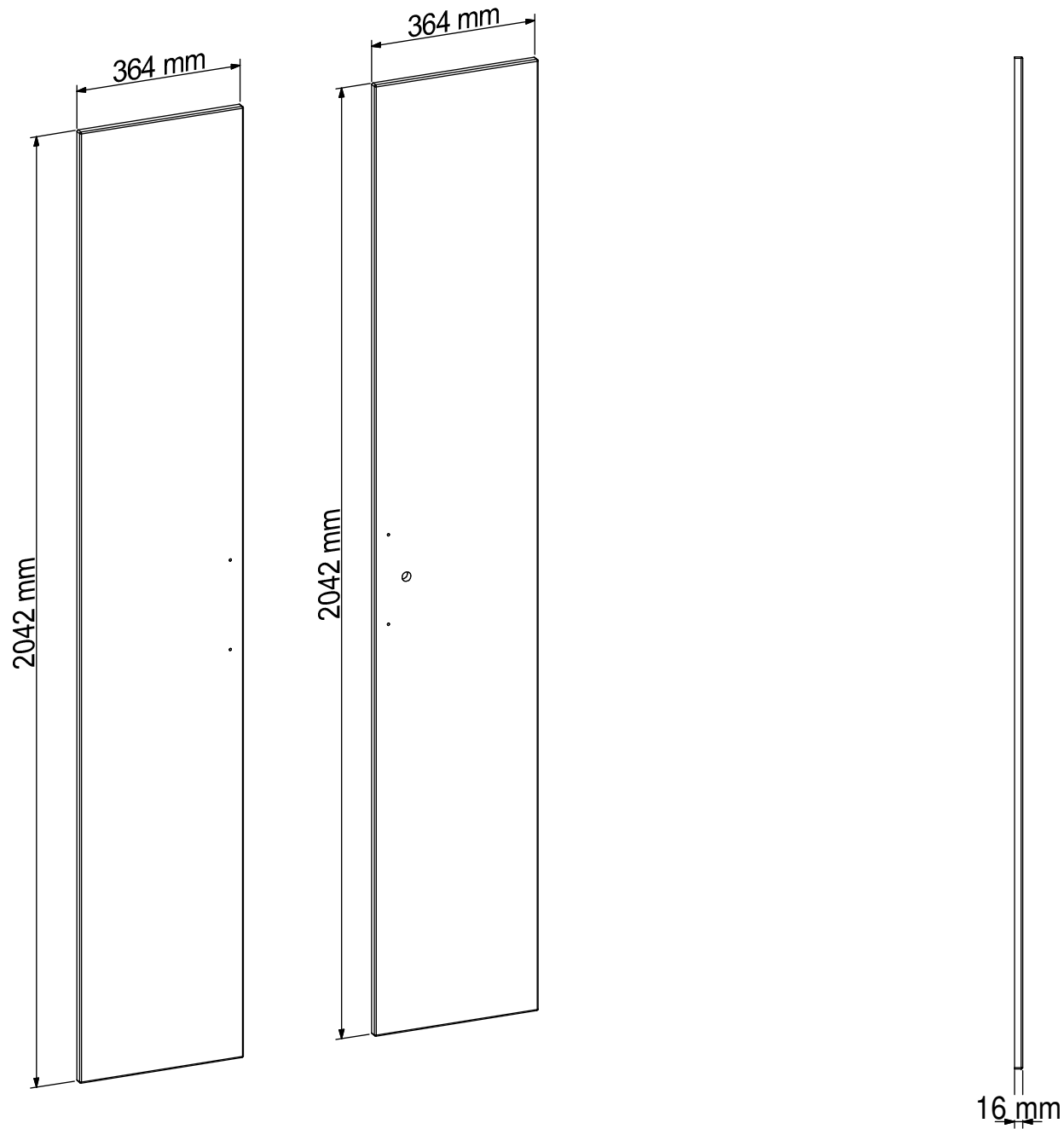

- 1 2x hamulec a203
- 6x a210
- 4x $\varnothing 3 \times 20$ mm p14
- 1x z33

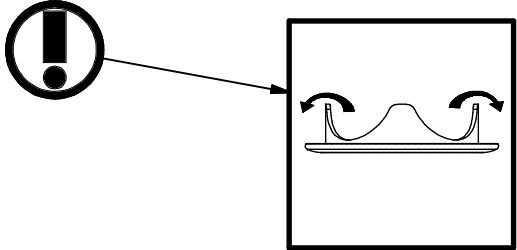
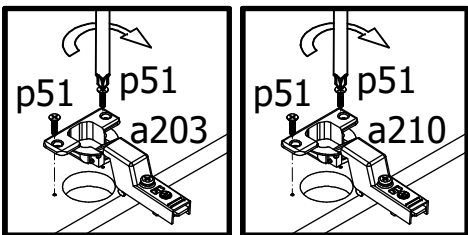
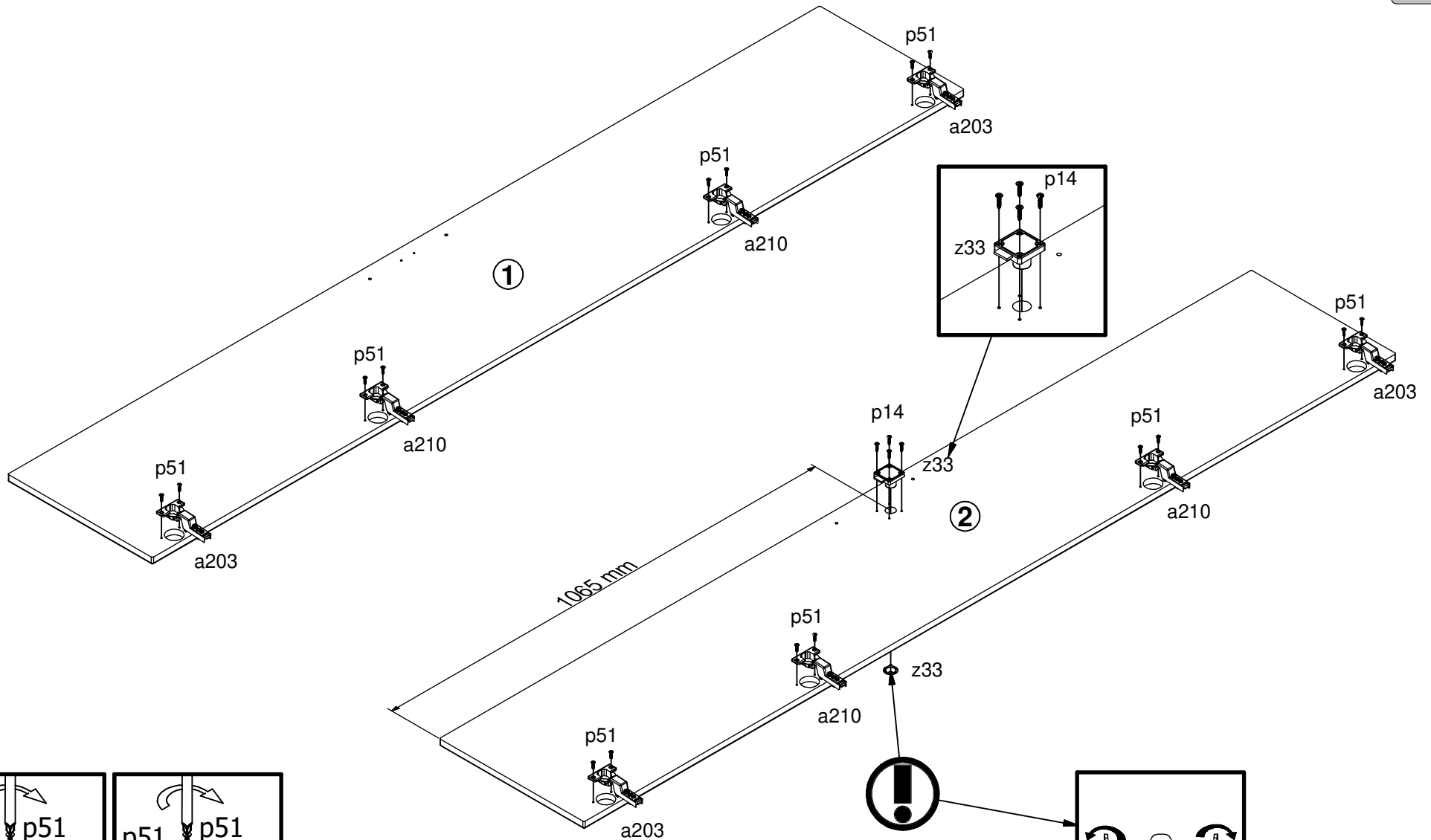



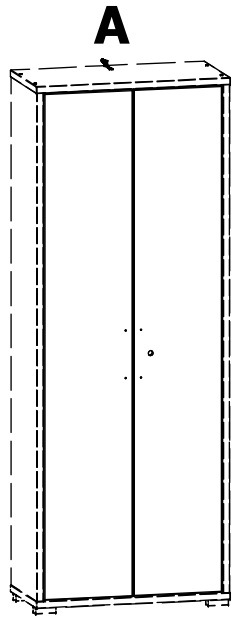

2A

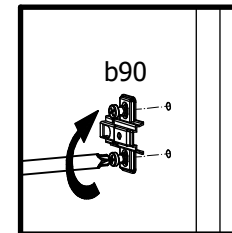
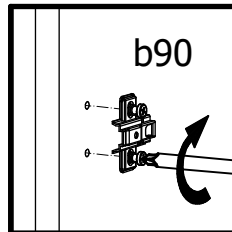
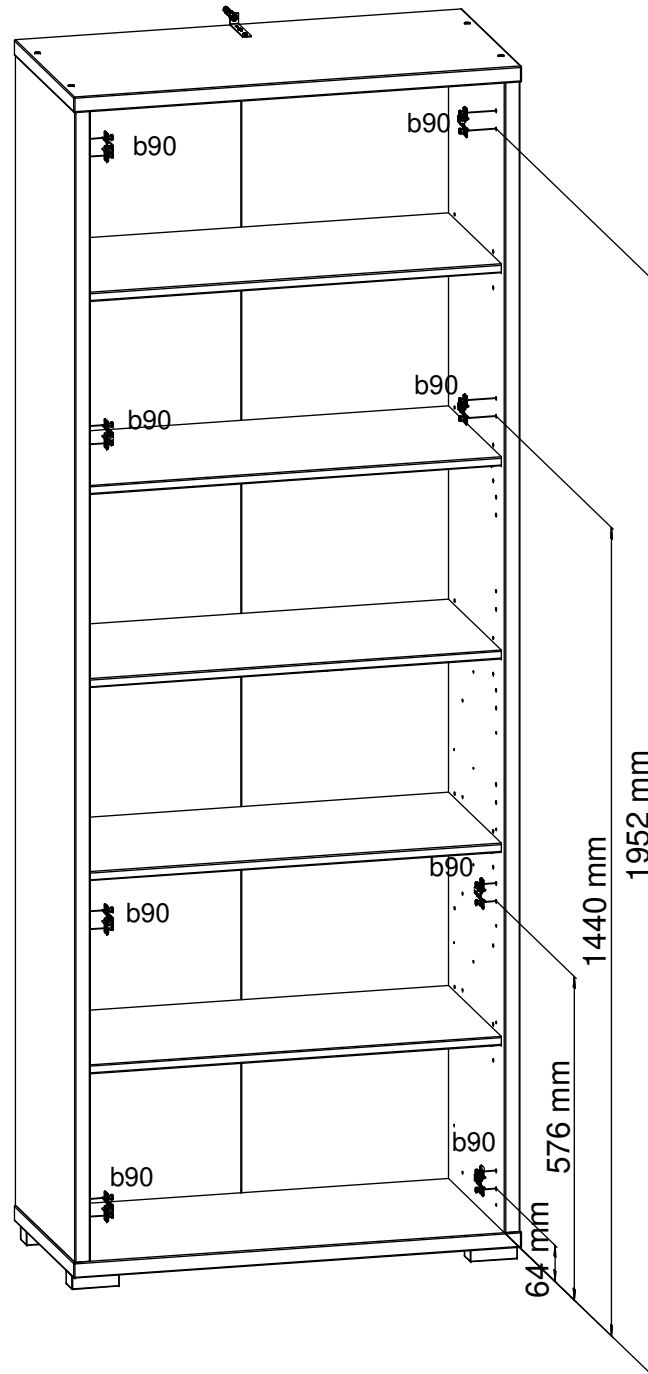



S643-REG/213/80

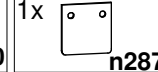
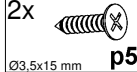

3A

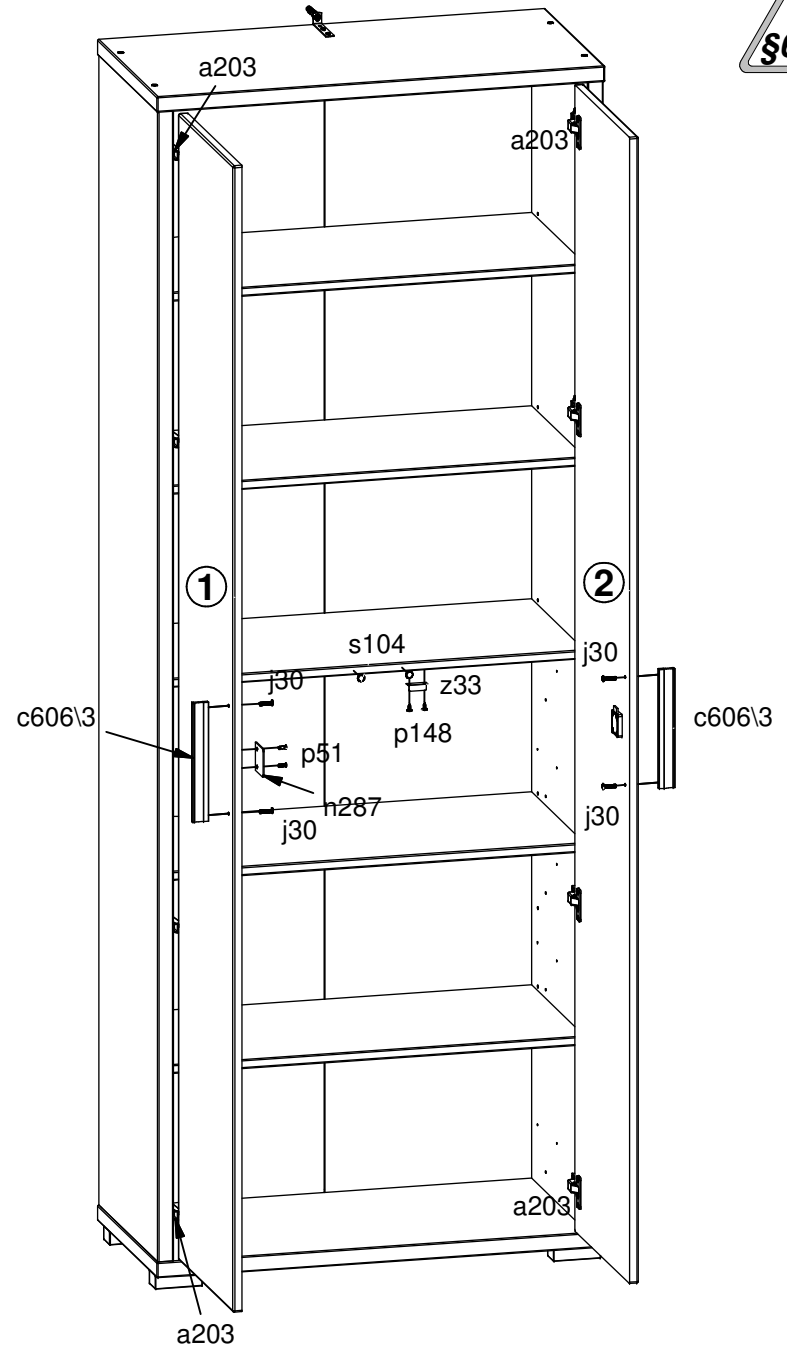
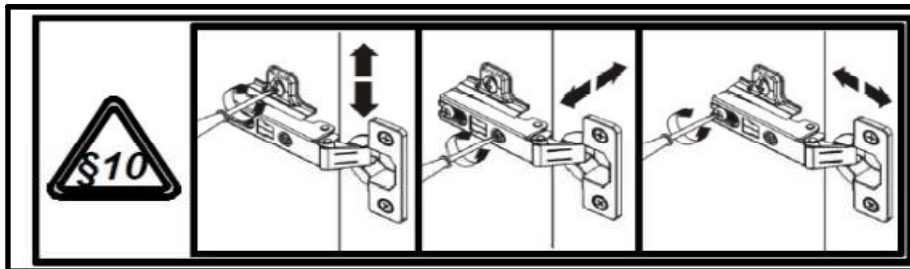
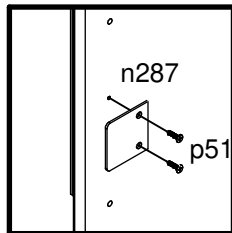
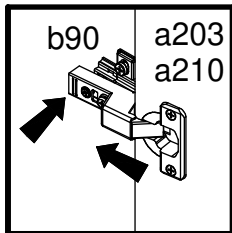
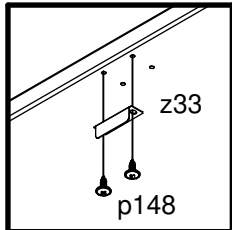
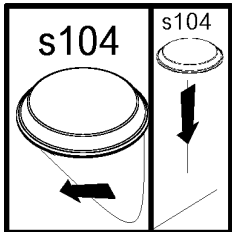
- 2x  c606\3
- 4x  j30
- 1x  n287
- 2x  p51
- 2x  p148
- 2x  s104 silikon



2B  4x b90

B

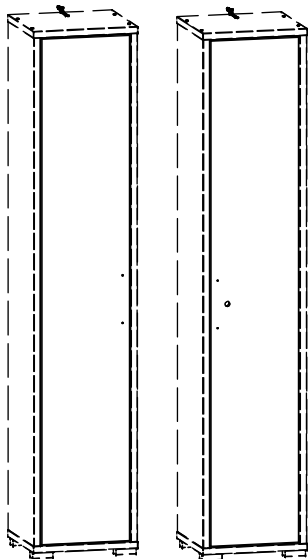

S643-REG/213/43

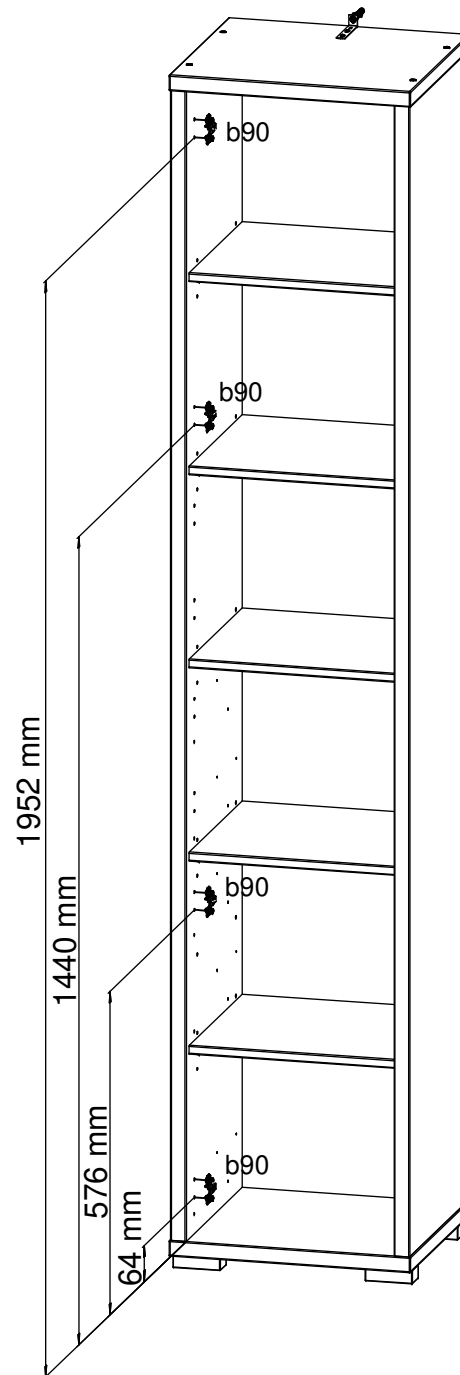
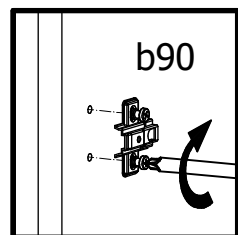

3B

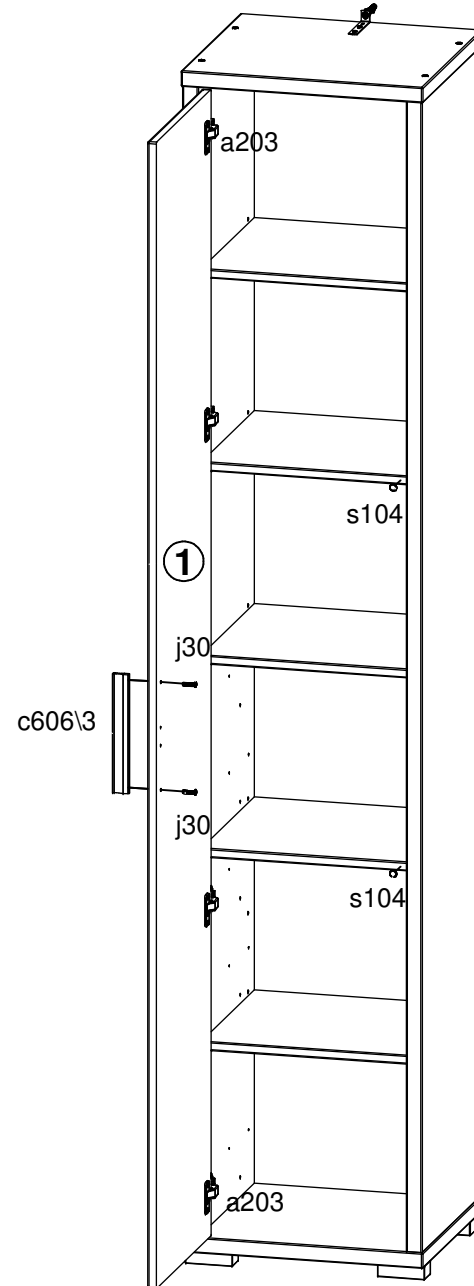
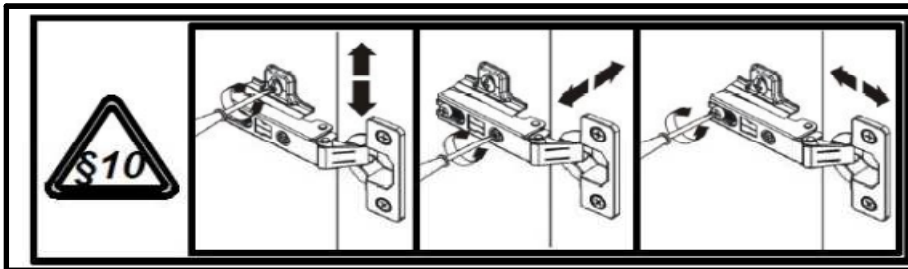
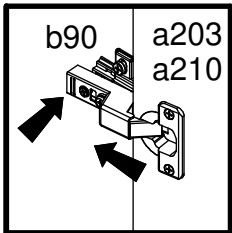
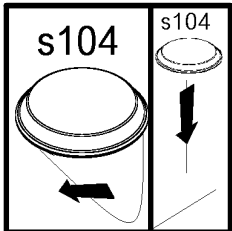
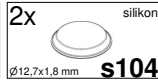
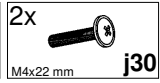
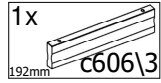

4B

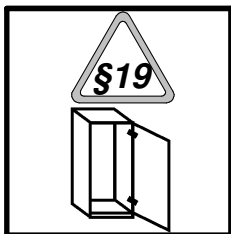
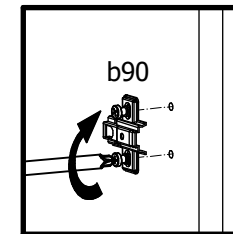
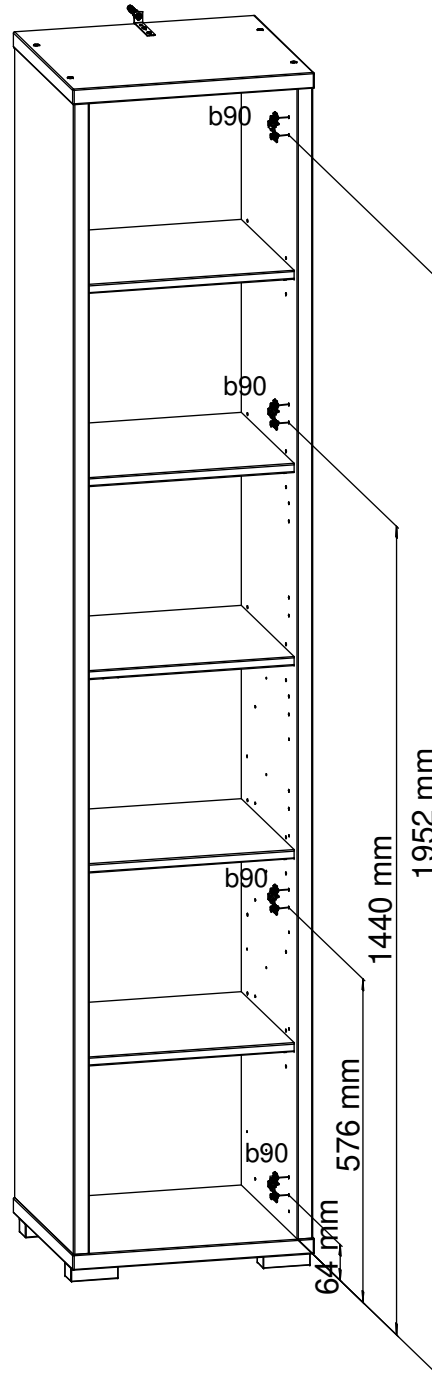

5B

