

MONTAGEANLEITUNG

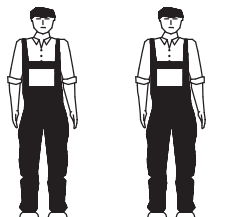

2 Pers.

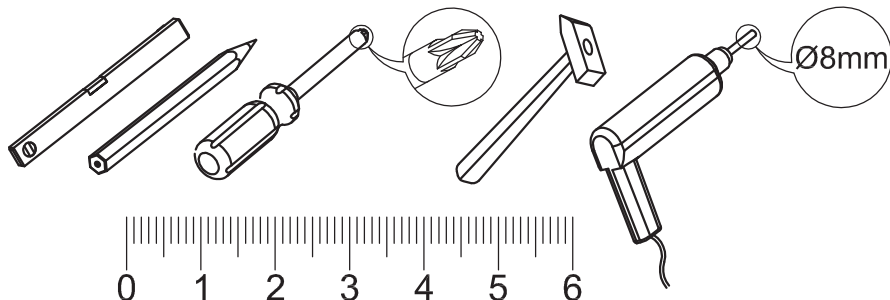

HIGHBOARD 3T / 3SK

ART:BRX1CT05

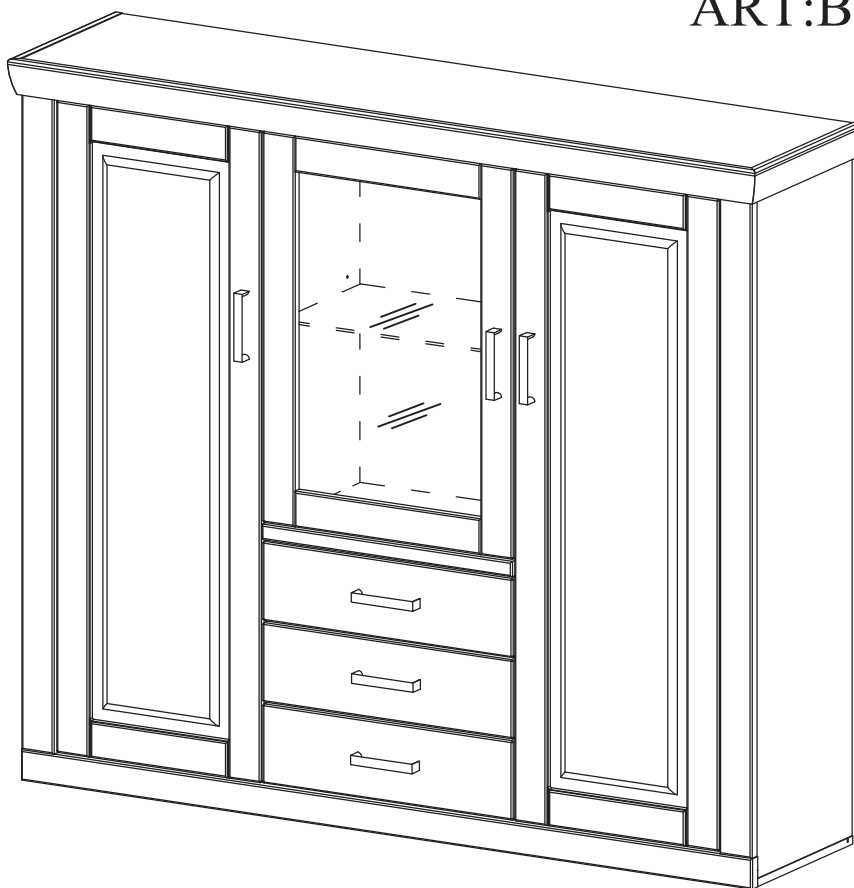

BESCHLÄGLISTE

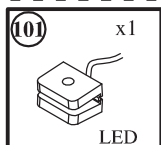
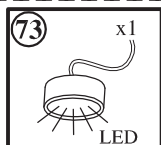
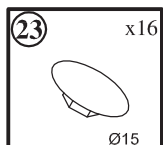
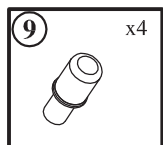
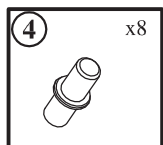
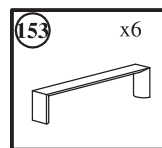
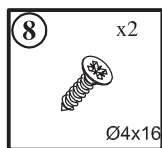
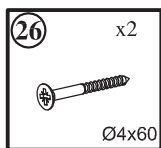
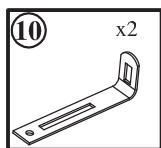
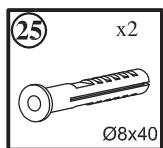
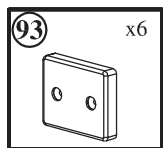
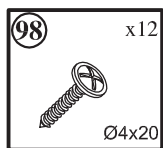

OPTION

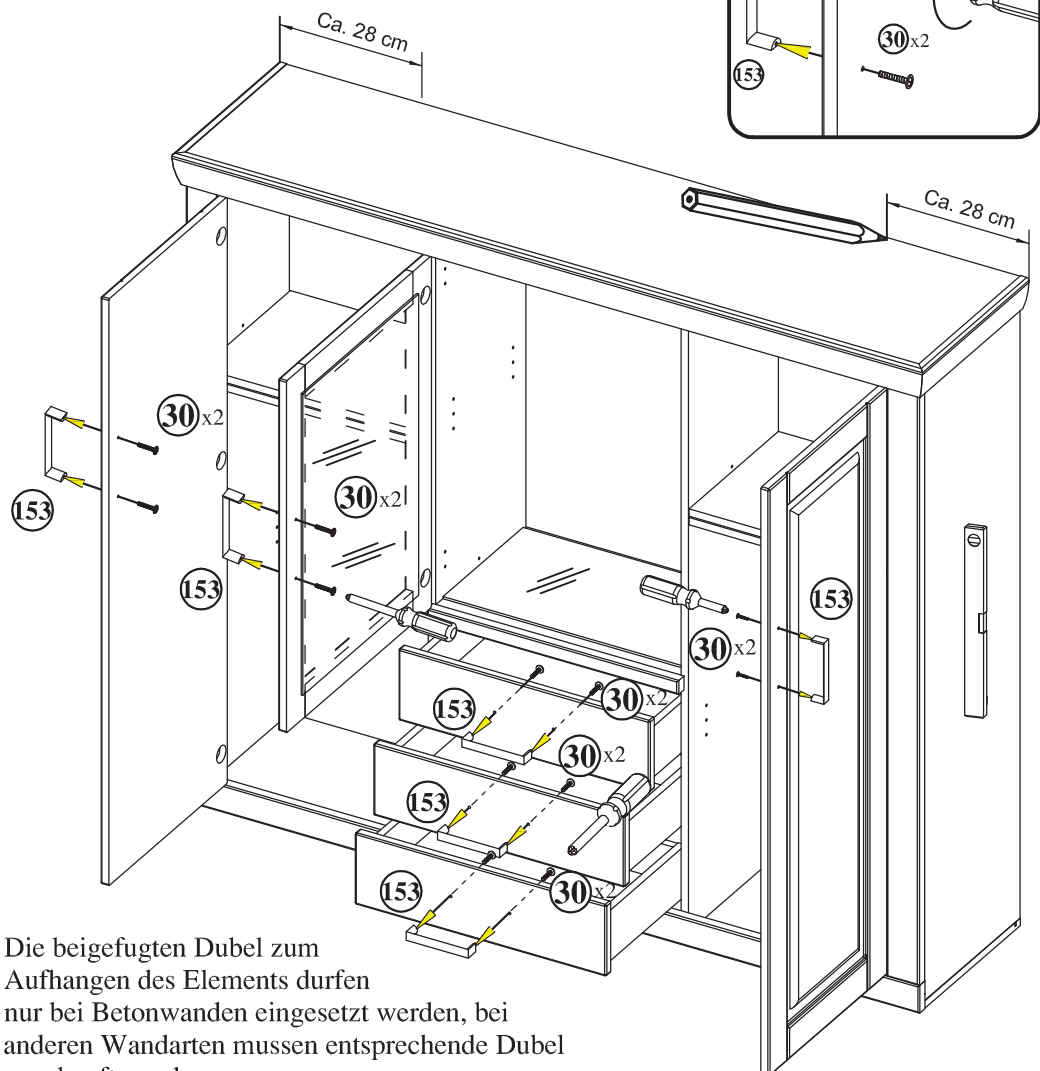
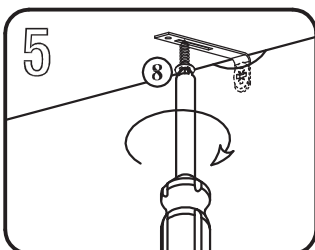
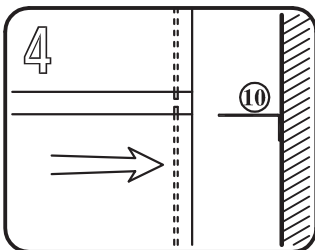
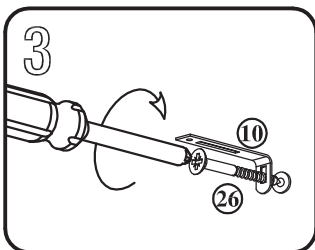
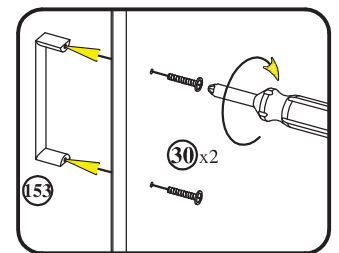
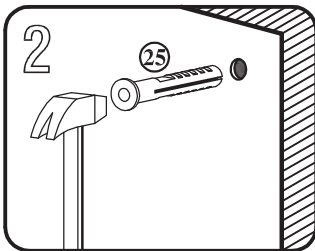
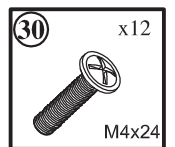
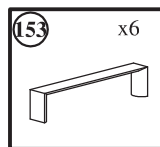
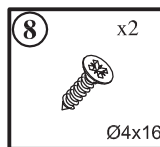
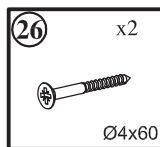
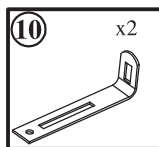
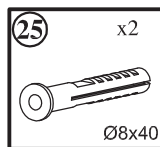
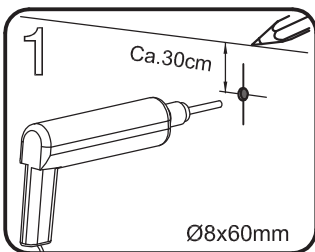
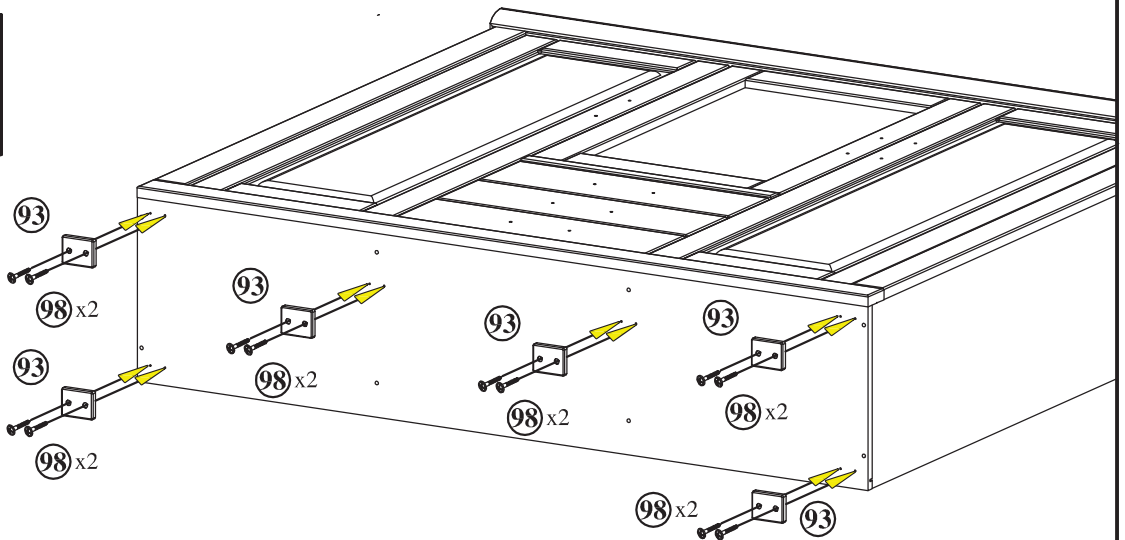
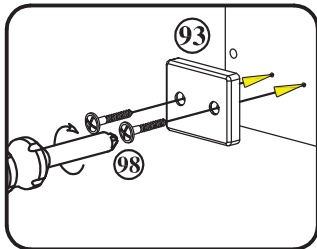
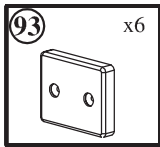
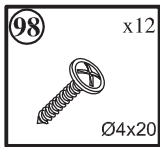

Die beigelegten Dübel zum Aufhängen des Elements dürfen nur bei Betonwänden eingesetzt werden, bei anderen Wandarten müssen entsprechende Dübel zugekauft werden.

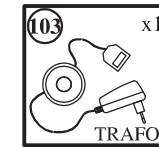
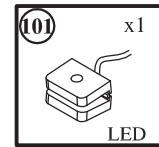
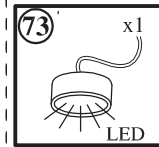
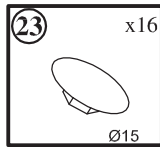
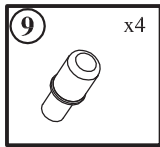
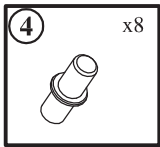

OPTION

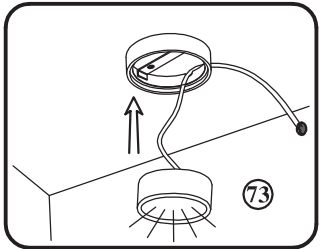
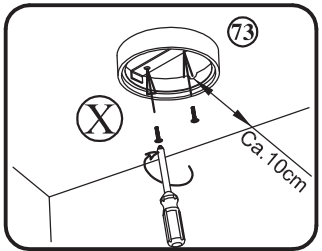
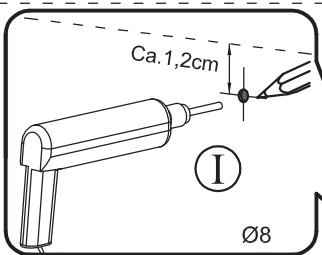
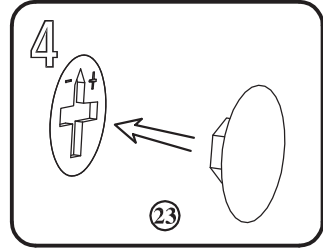
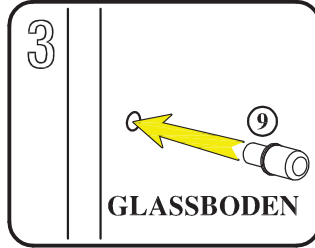
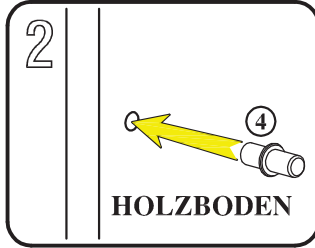
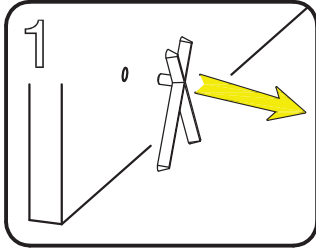

OPTION

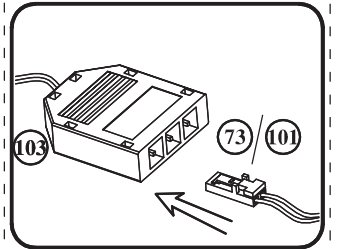
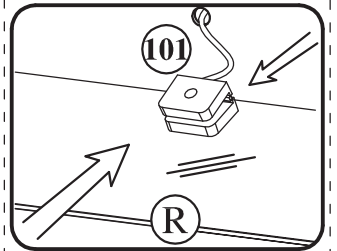
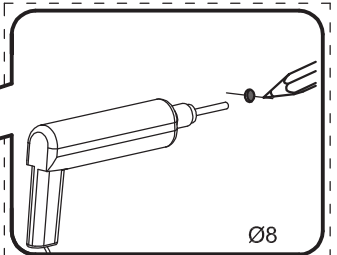
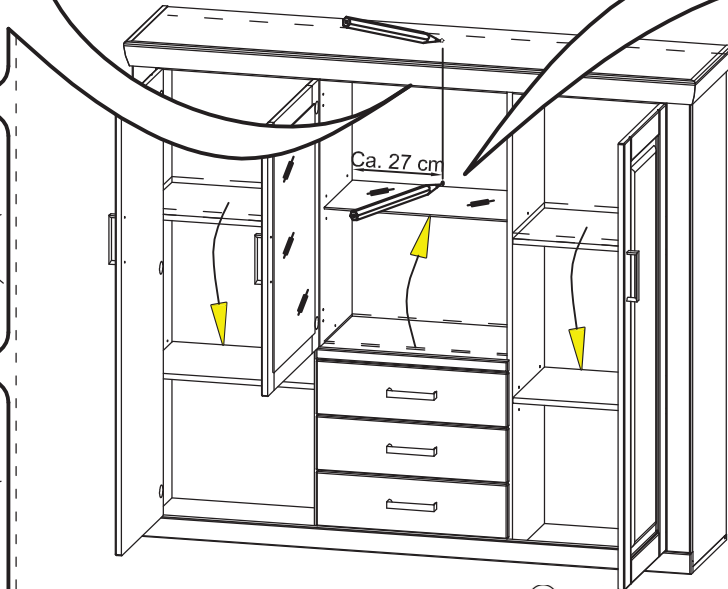

OPTION

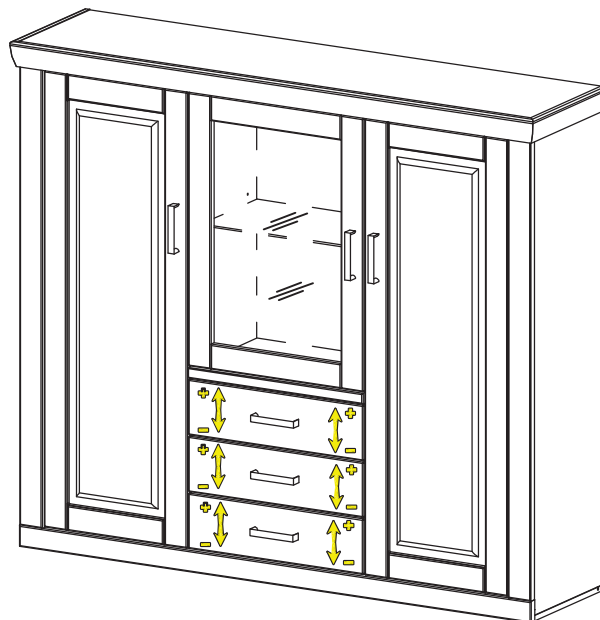
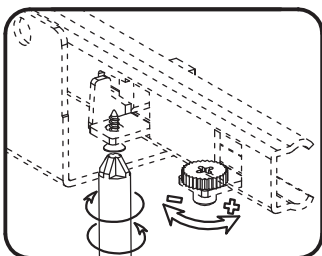
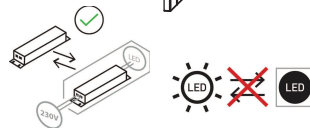

Pflegehinweis !

Bitte nur mit einem Staubtuch oder einem feuchten Lappen reinigen.

KEINE scheuernde Putzmittel verwenden !

Verstellmöglichkeiten

a)
Fugenverstellung:
Befestigungsschraube "A" lockern,
gewünschte Fuge mit Schraube "B"
einstellen. Schraube "A" anziehen.

b)
Tiefenverstellung:
Befestigungsschraube "A" lockern,
Bandarm nach voren oder
rückwärts verschieben, Schraube "A"
anziehen, Schraube "B" mit
einer 1/4 Drehung nach rechts
arretieren.

c)
Hohenverstellung:
Befestigungsschraube "C" lockern,
Hohe einstellen, Schraube "C"
anziehen.

