

A

S643-REG/213/80

CONNECT

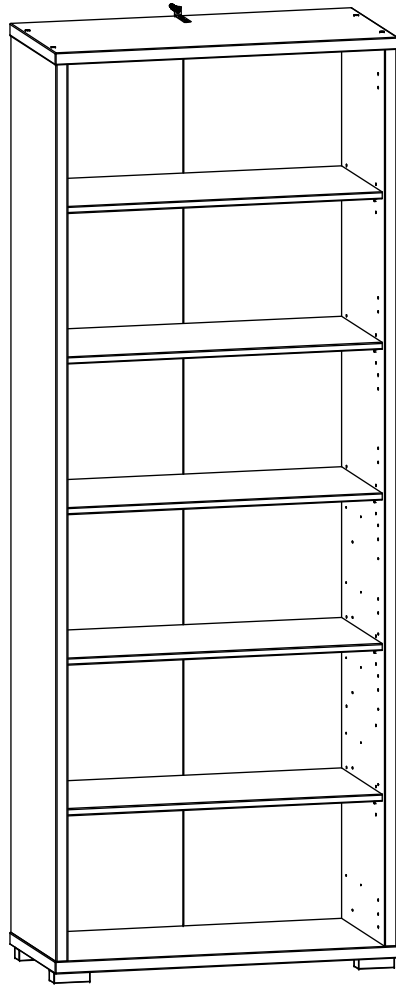

24270215/01
24270215/02

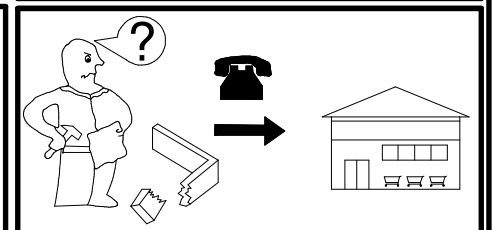
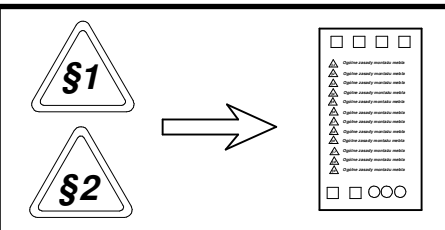
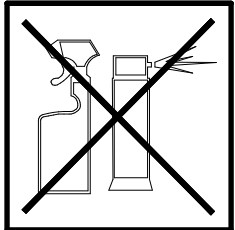
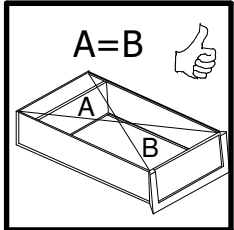
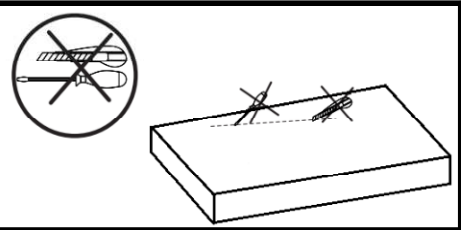
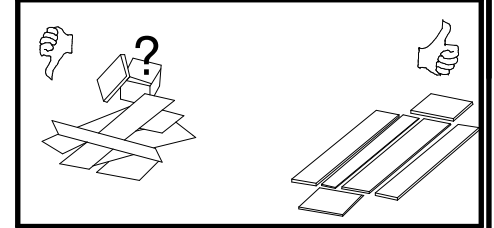
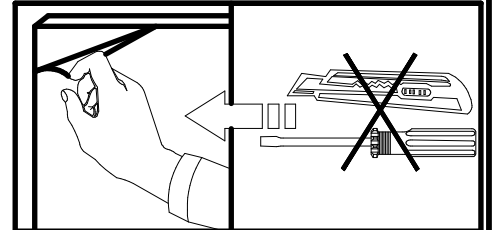
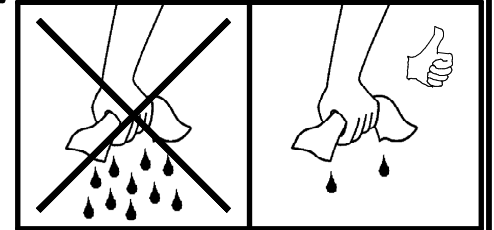
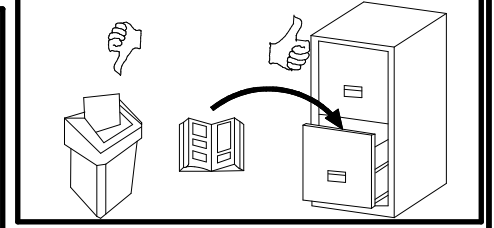
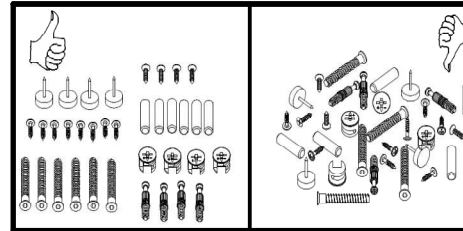
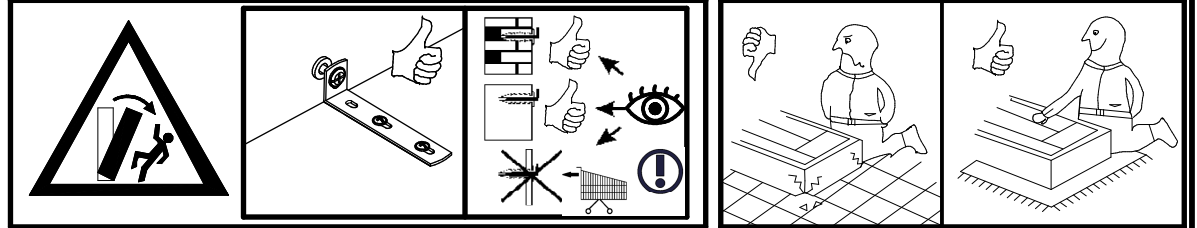

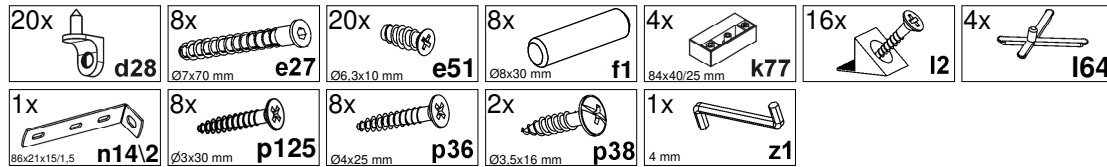
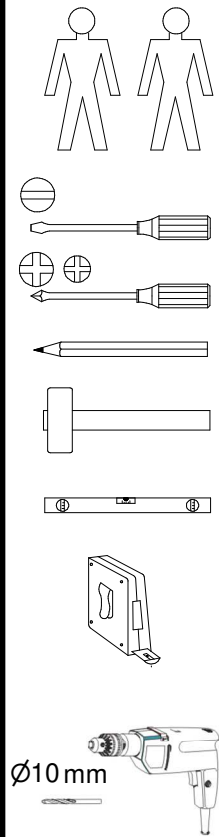

A	B1	B2	C1	C2	C3	D
1	S643-1001	-	2048	393	28	1/2
2	S643-1002	-	2048	393	28	1/2
3	S643-2001	-.1	797	395	28	2/2
4	S643-2002	-	797	395	28	2/2
5	S643-3001	-	737	353	16	2/2
6	S643-5002	-	737	16	18	2/2
7	S643-9301	-	2058	747	2,5	1/2

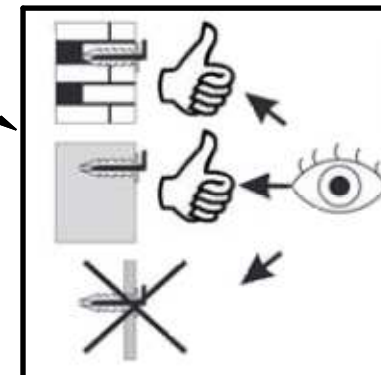

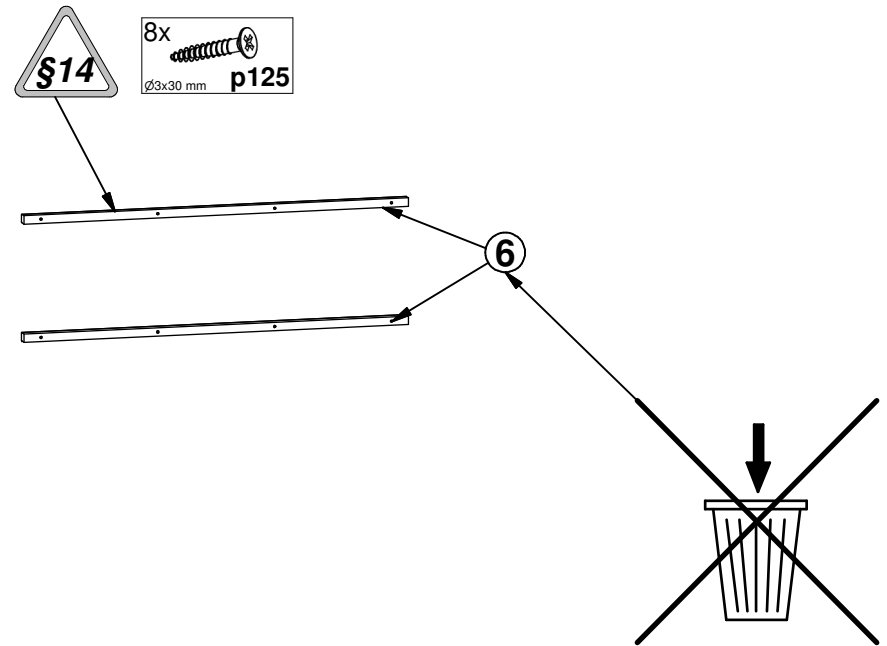
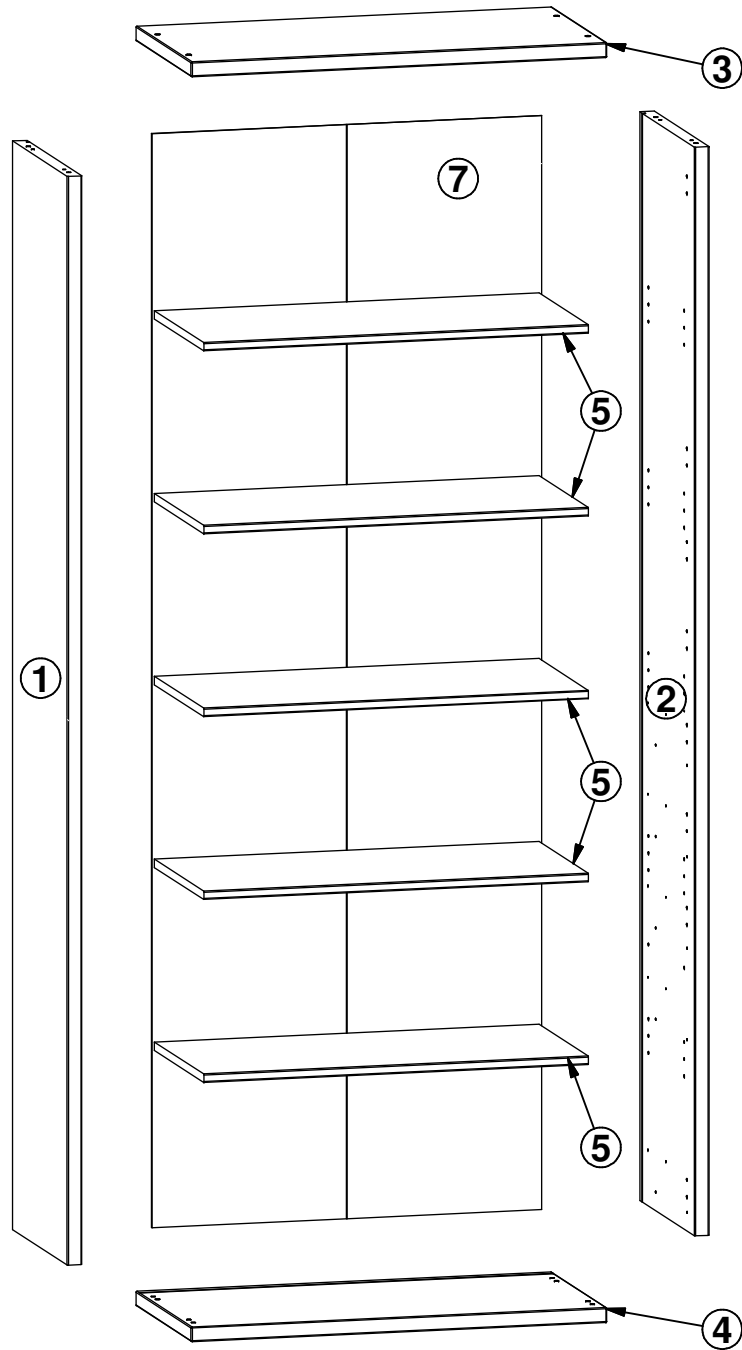

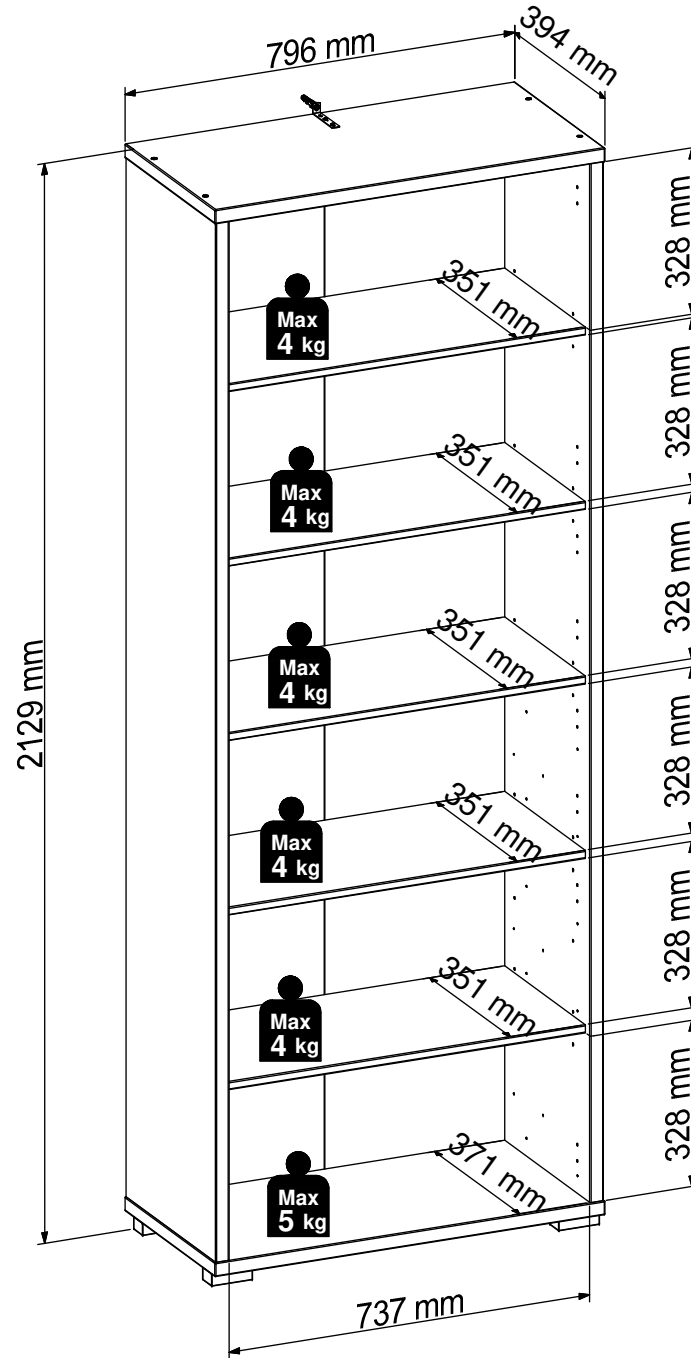

OPTION

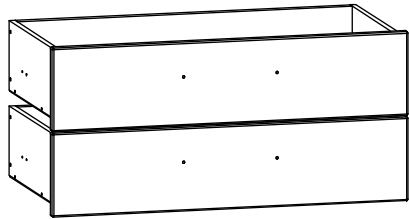

S643-SZU/80/35/A

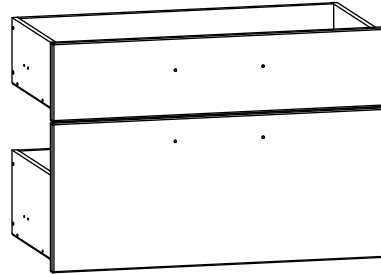
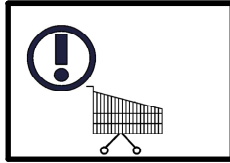

S643-SZU/80/50/A

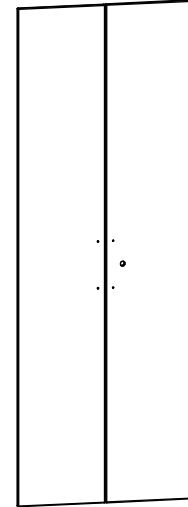

S643-FRN/205/80/A

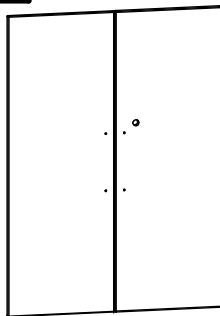

S643-FRN/101/80/A

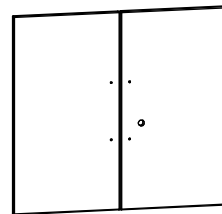

S643-FRN/67/80/A

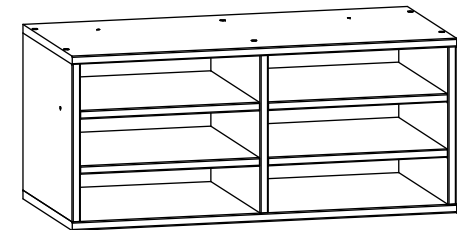

S643-POL/33/80

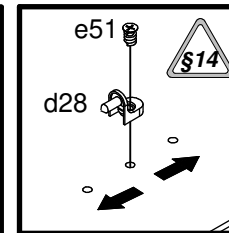
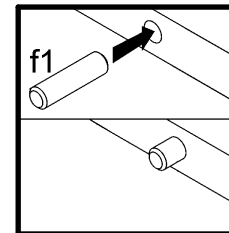
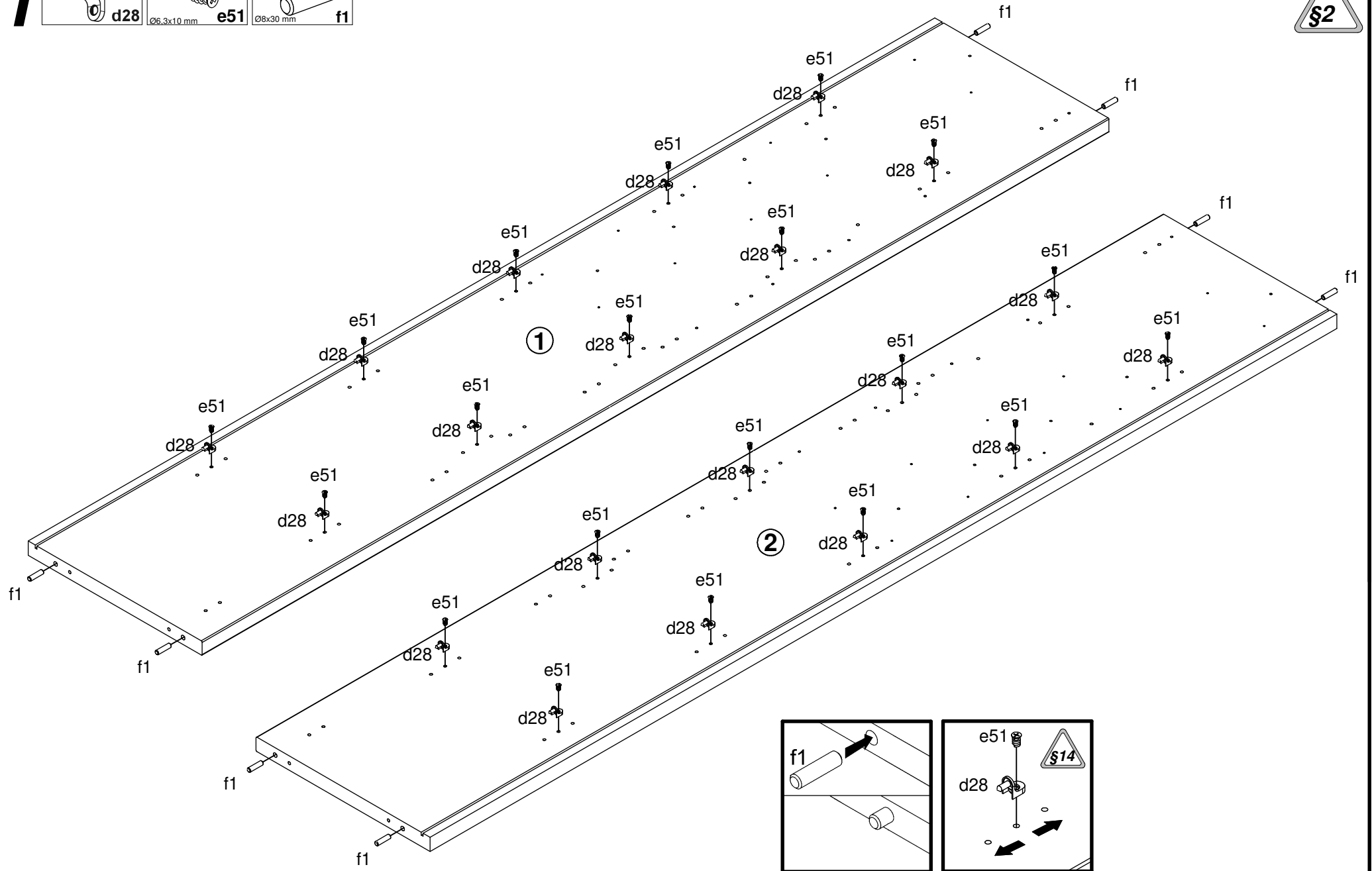
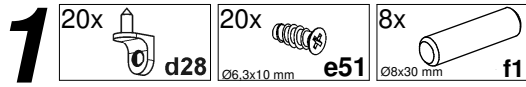

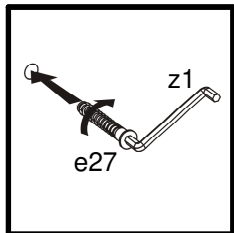
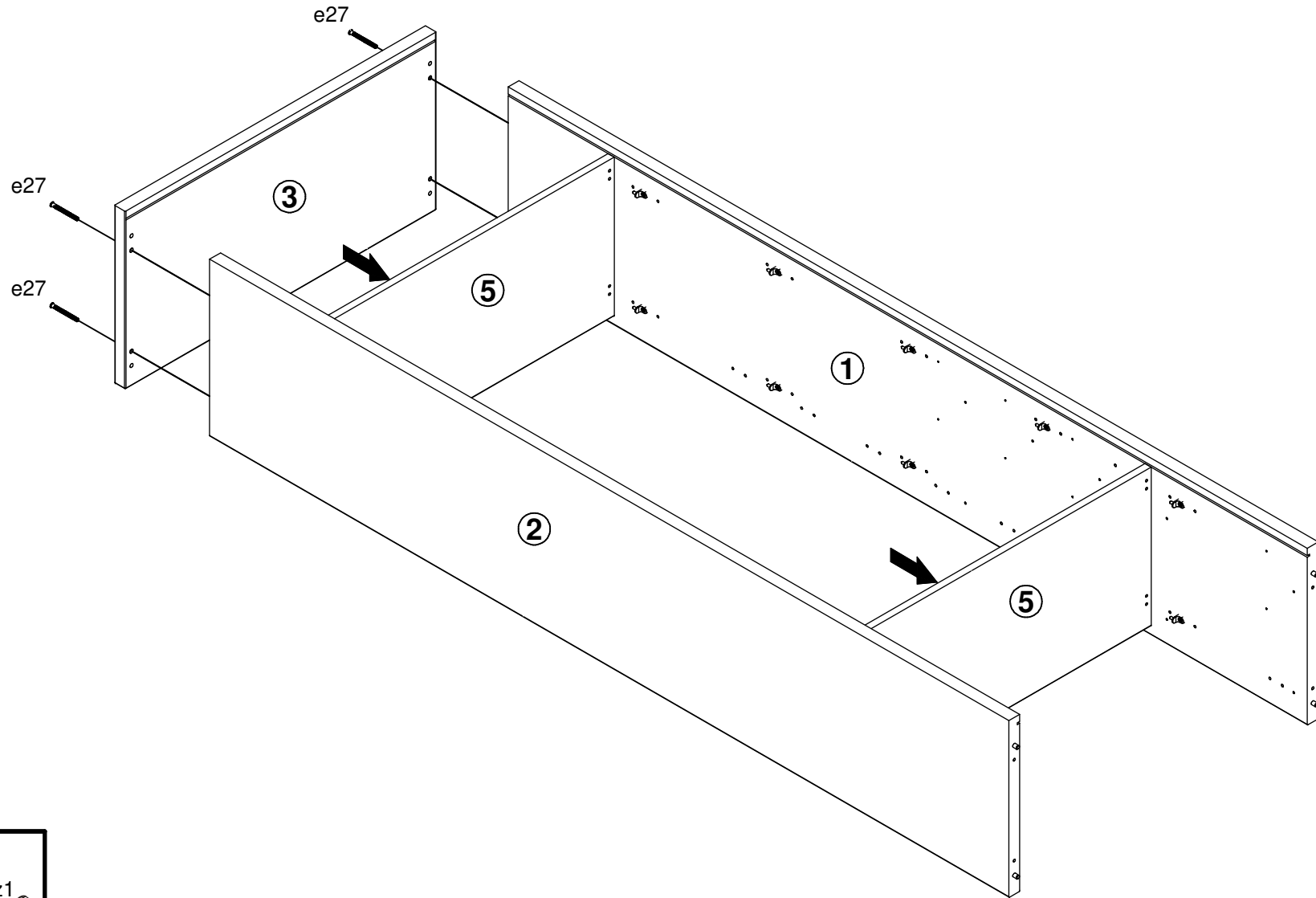
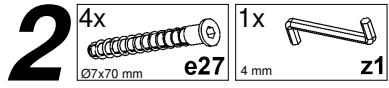

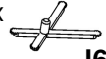
3 ^{4x}  I64

