

I

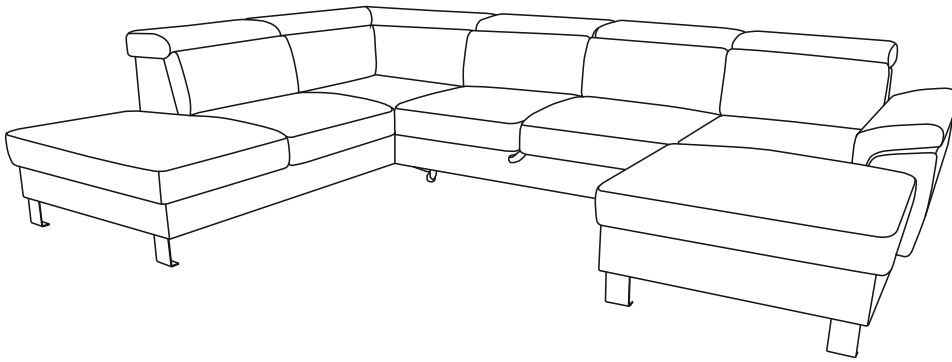

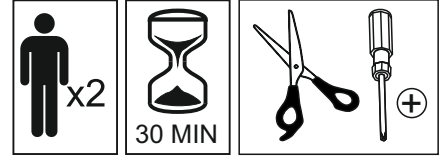

TIM 3S.2F.REC/BK
TIM REC/BK.2F.3S

11.03/2022

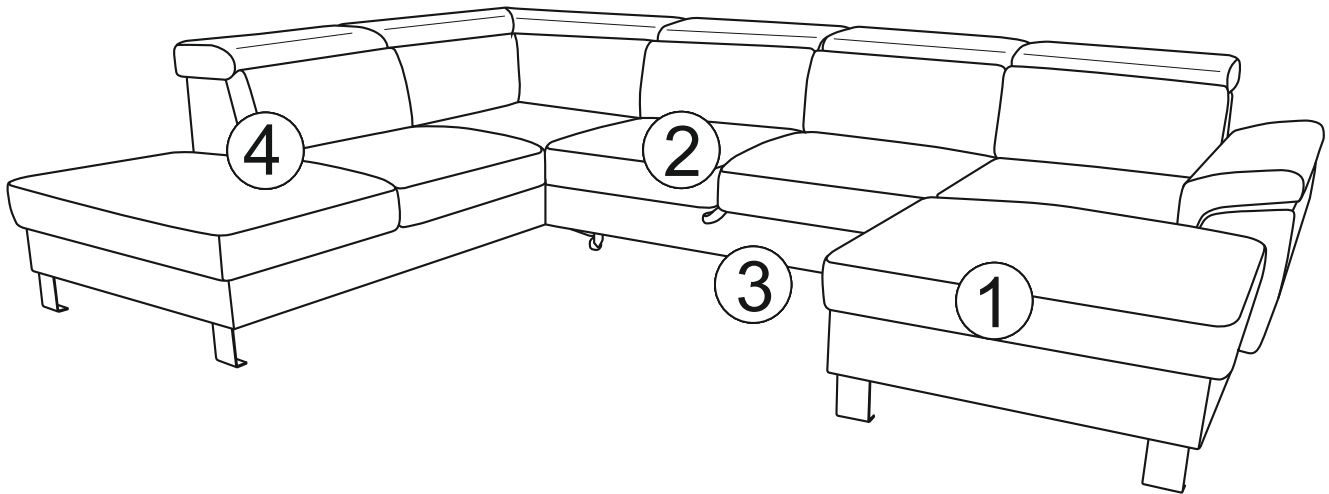
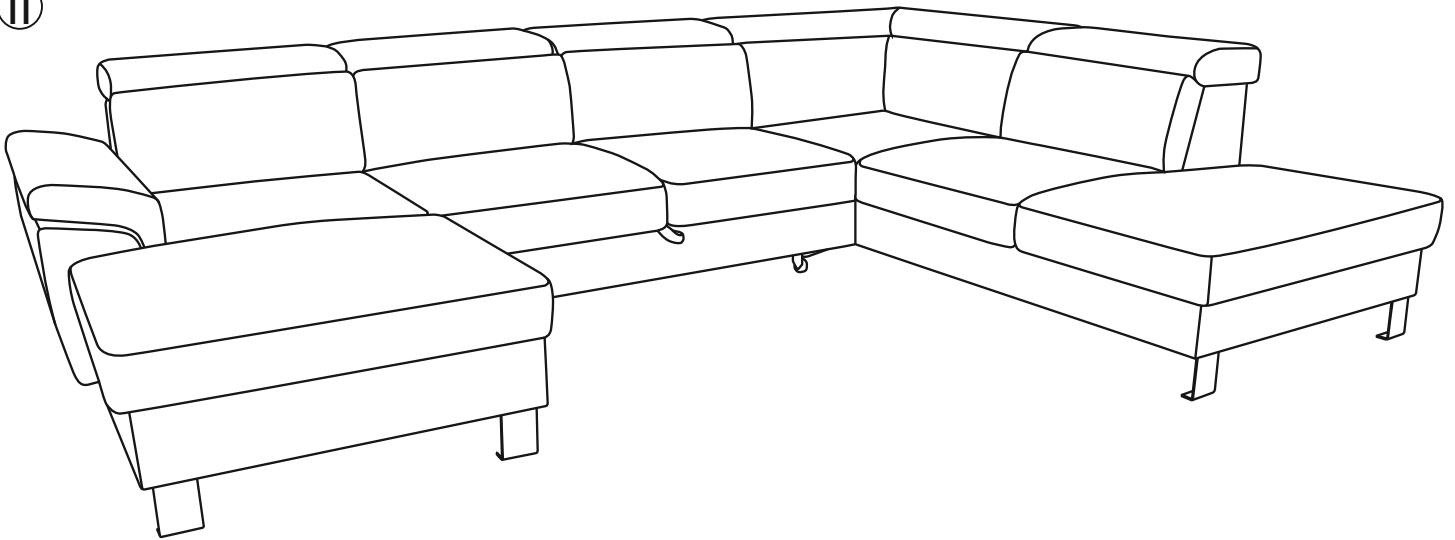

II

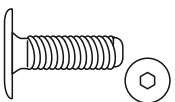
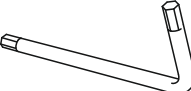

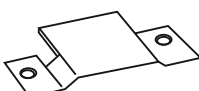
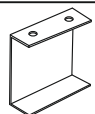
A  M6x20 Ax34	B   Bx1	C  Cx8
D  Dx9		

1

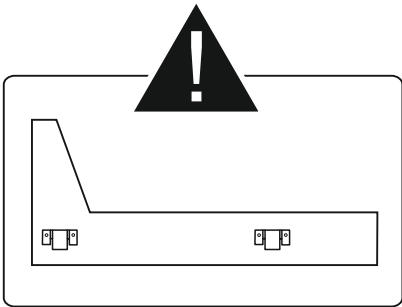
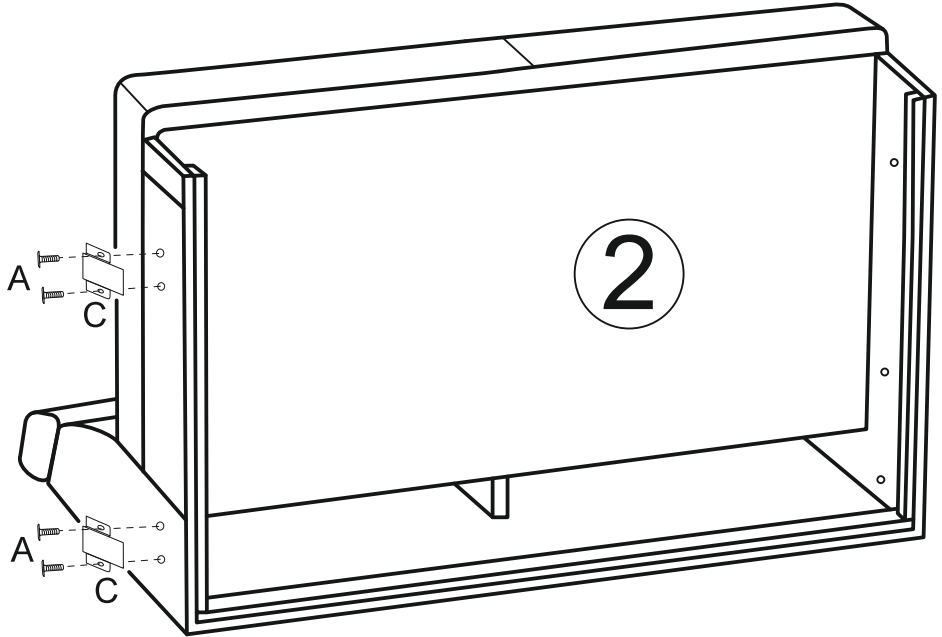
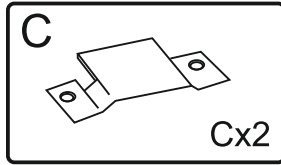
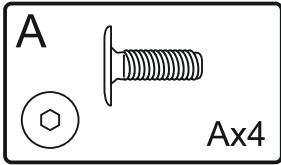

2

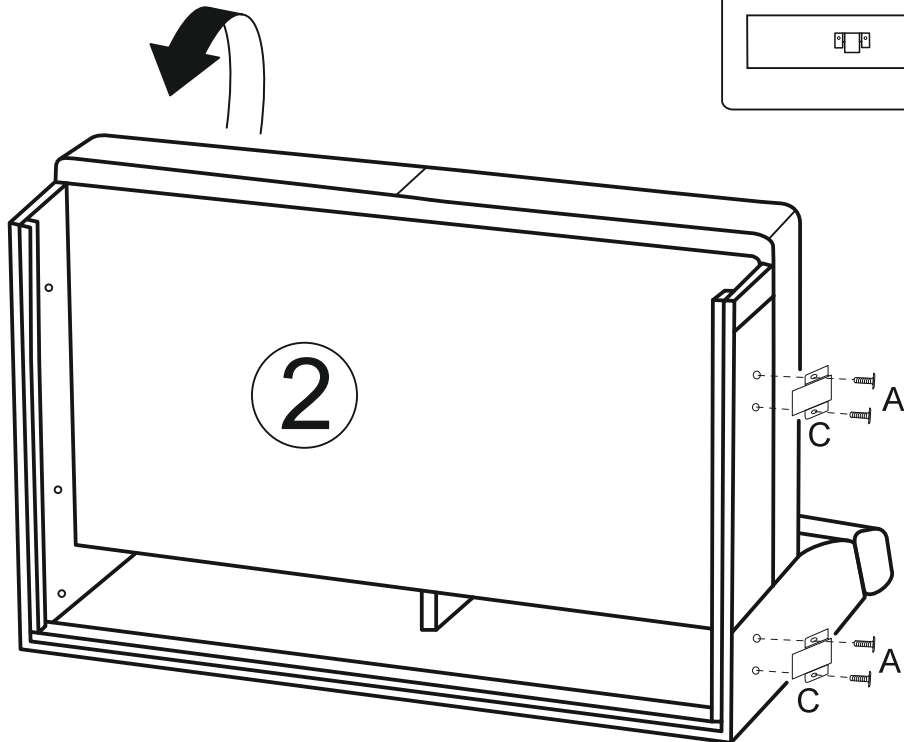
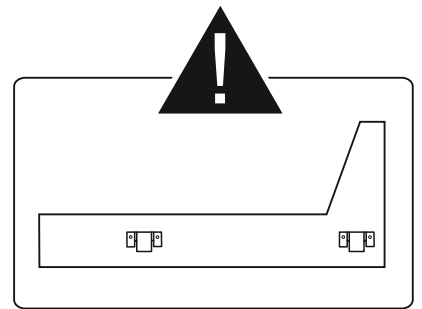
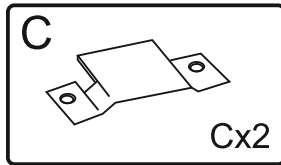
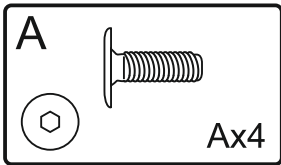

3I

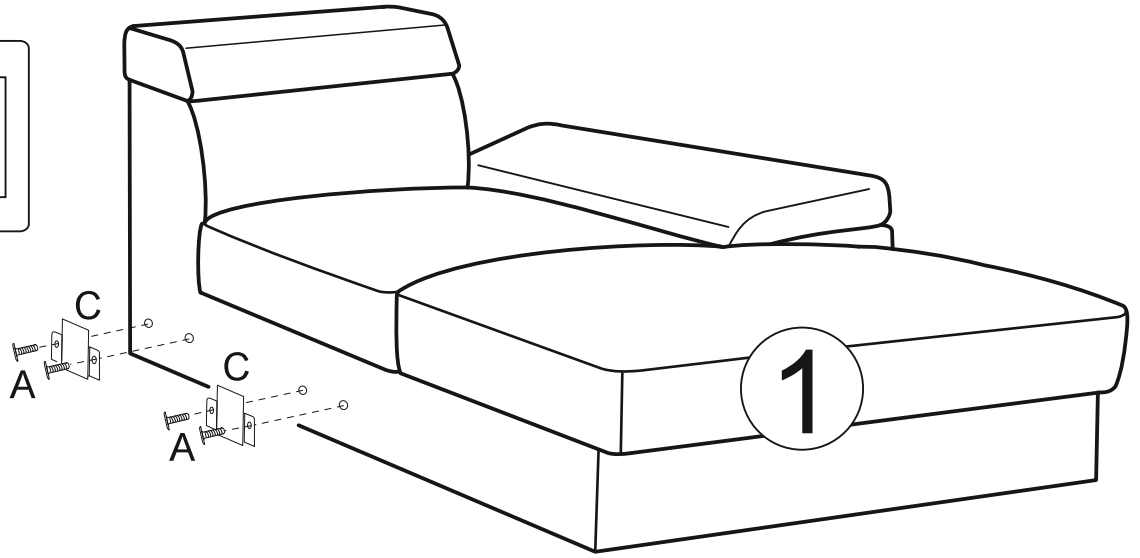
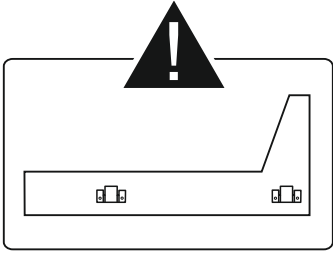
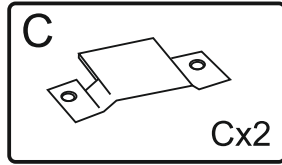
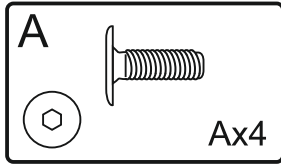

3II

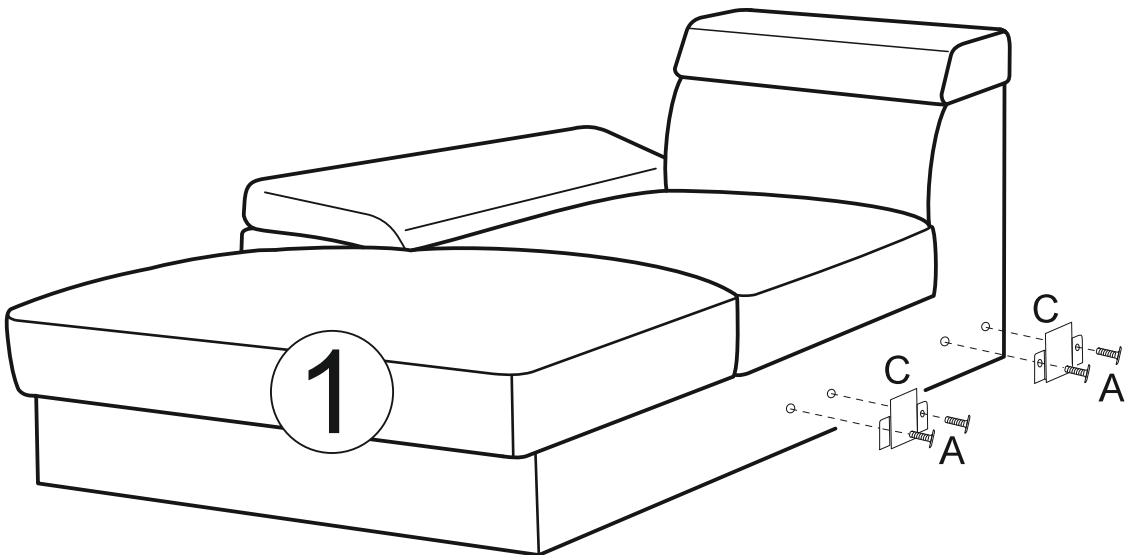
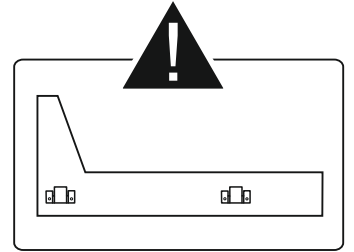
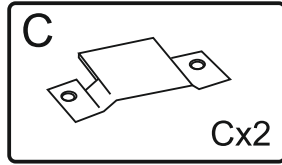
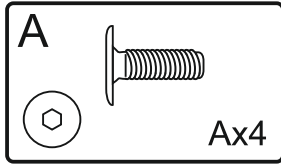

41

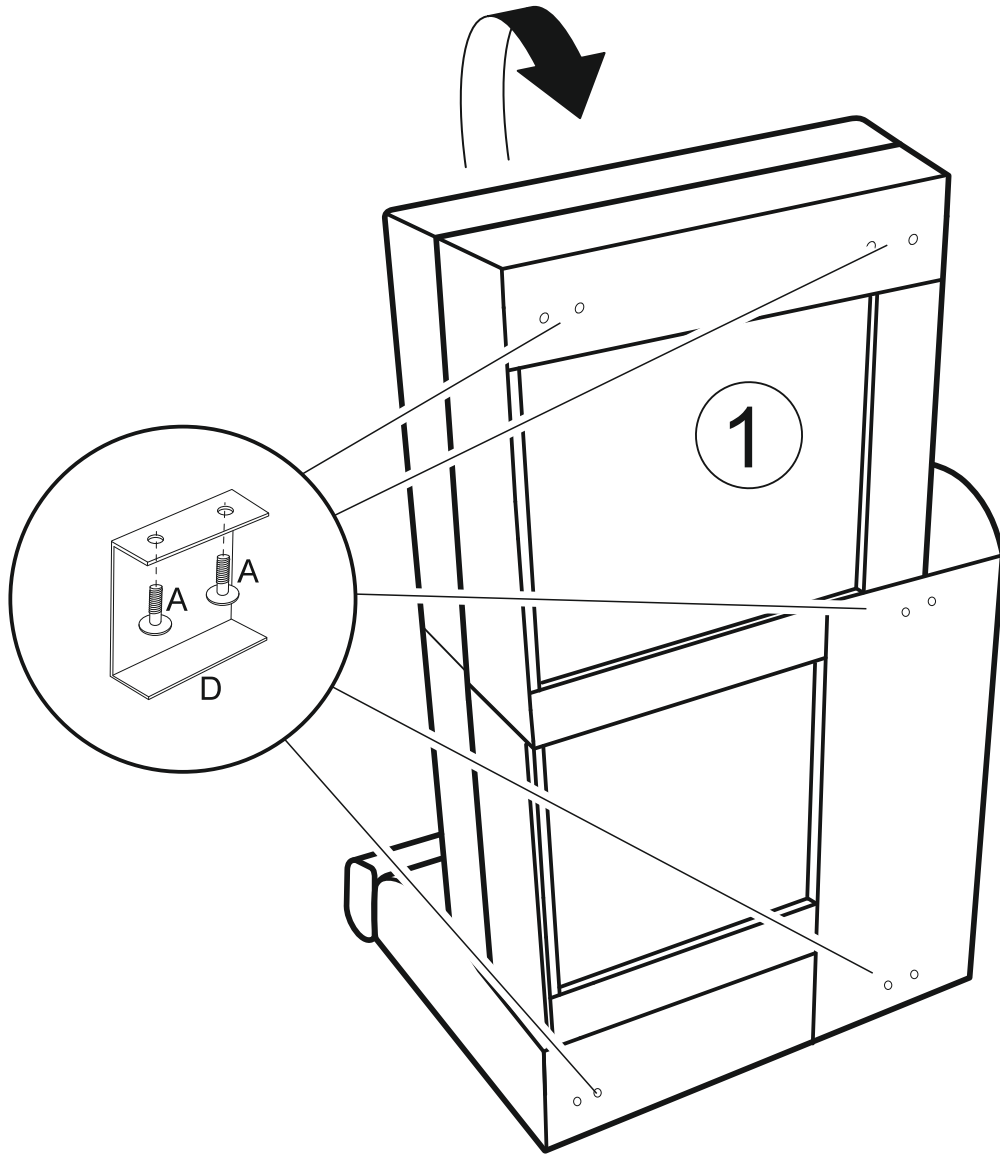
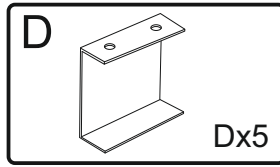
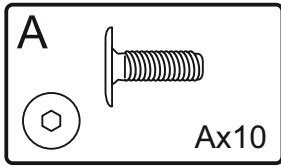

411

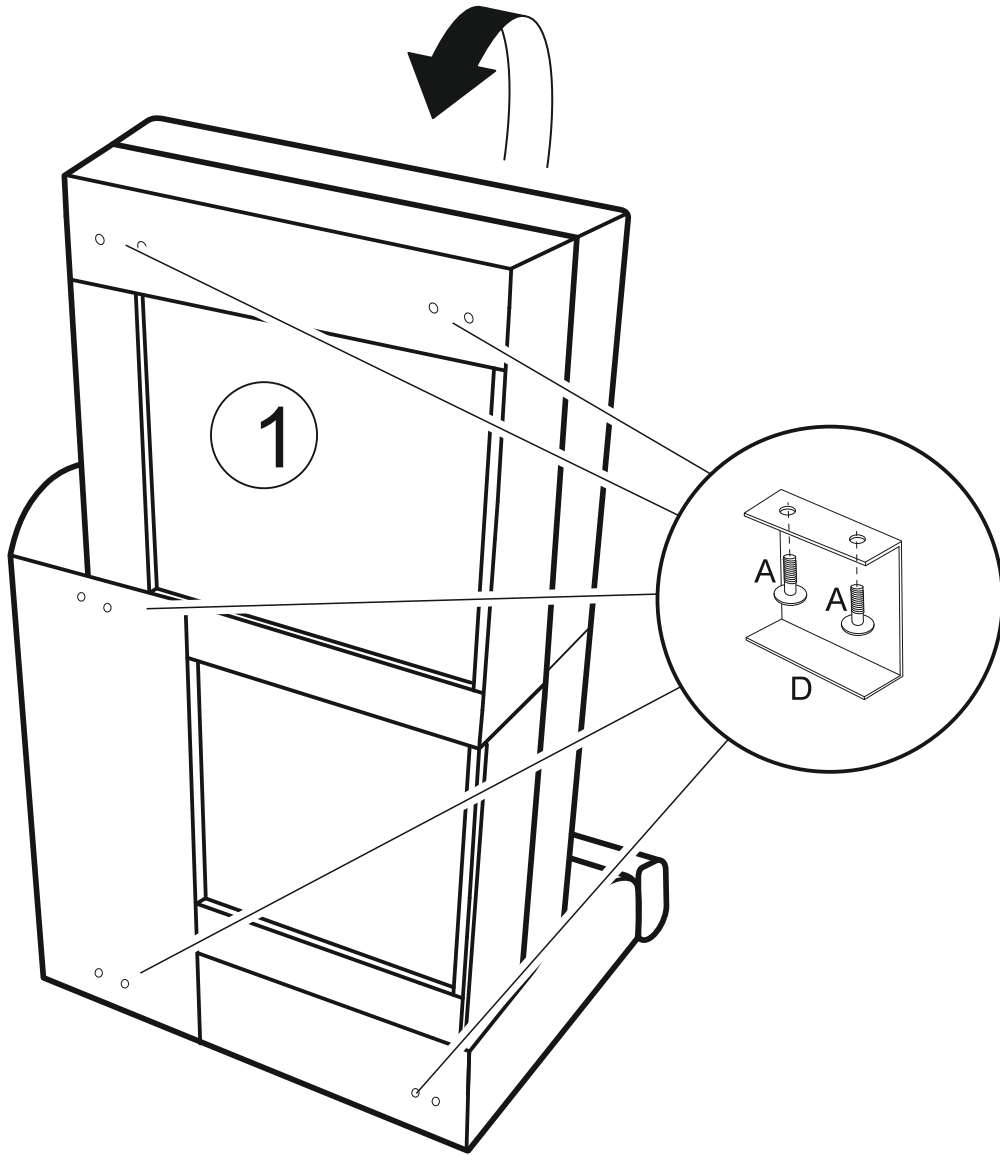
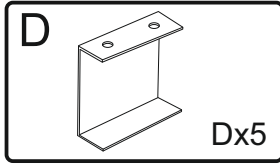
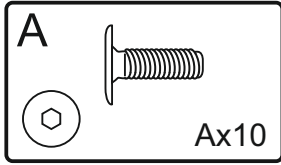

51

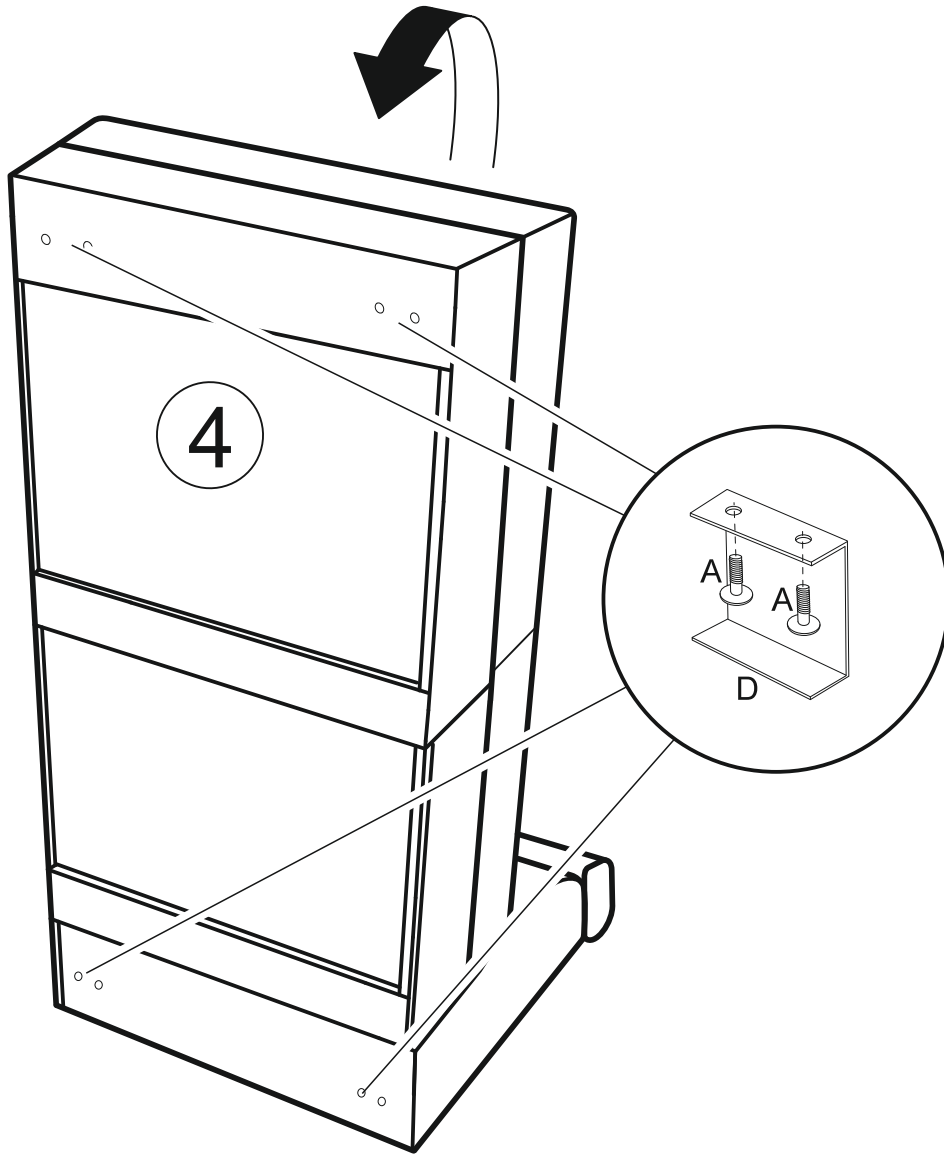
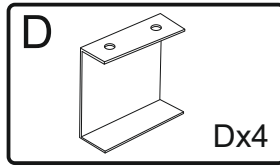
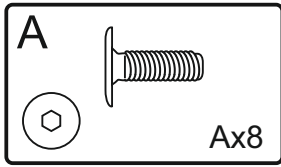

511

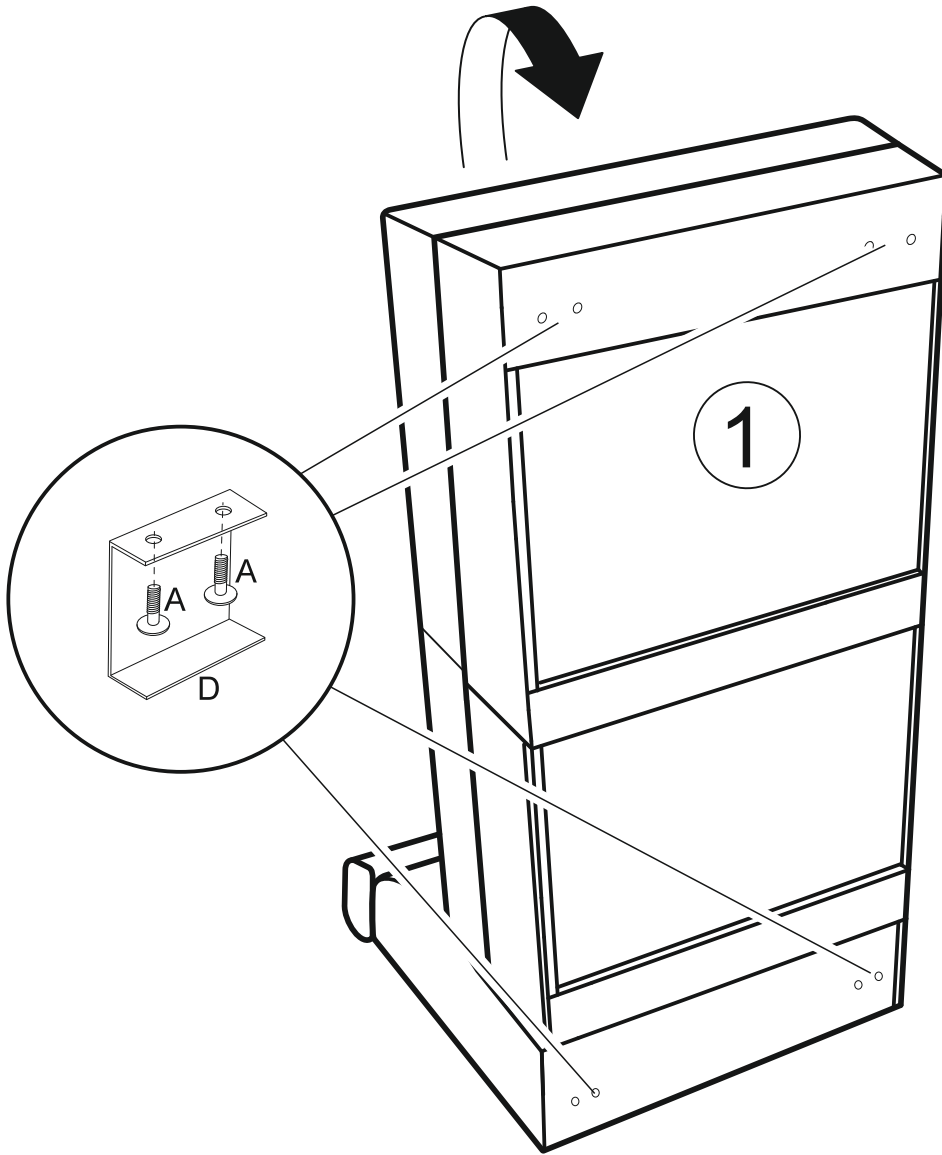
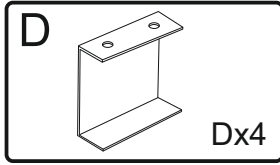
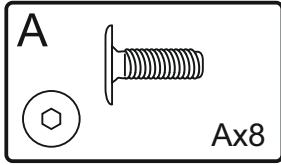

61

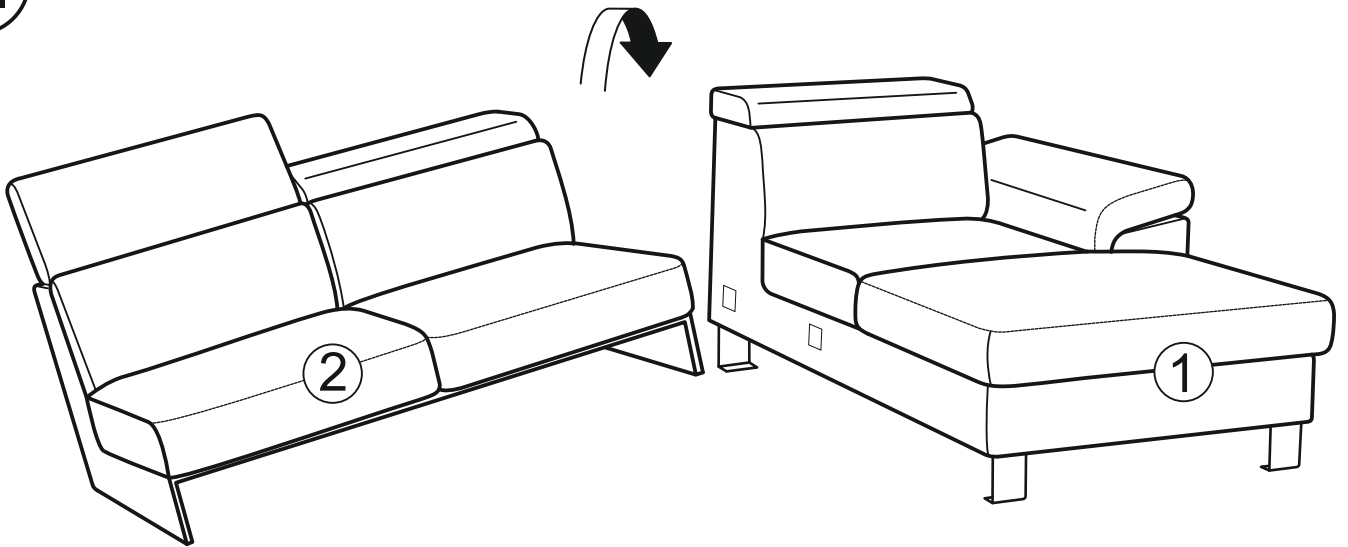

71

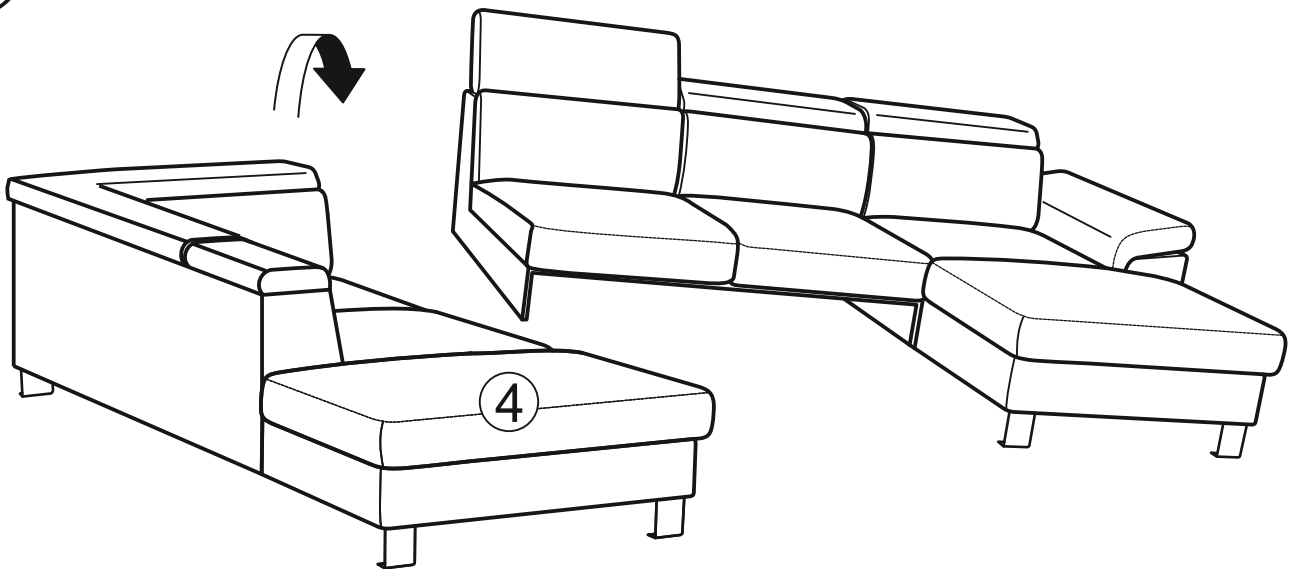

611

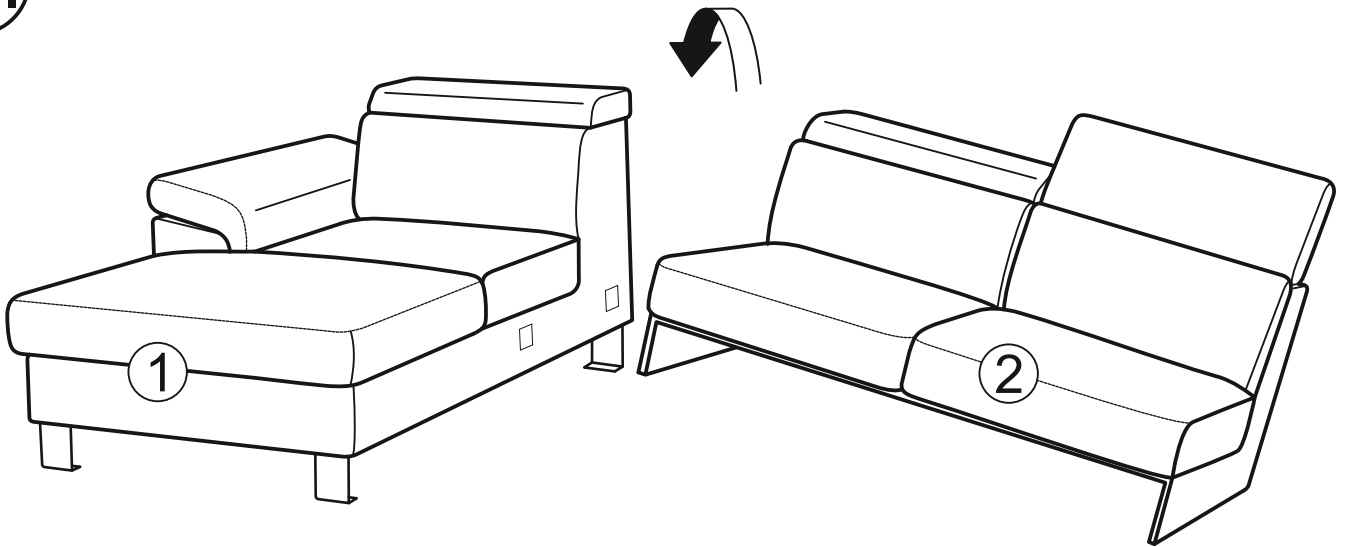

711

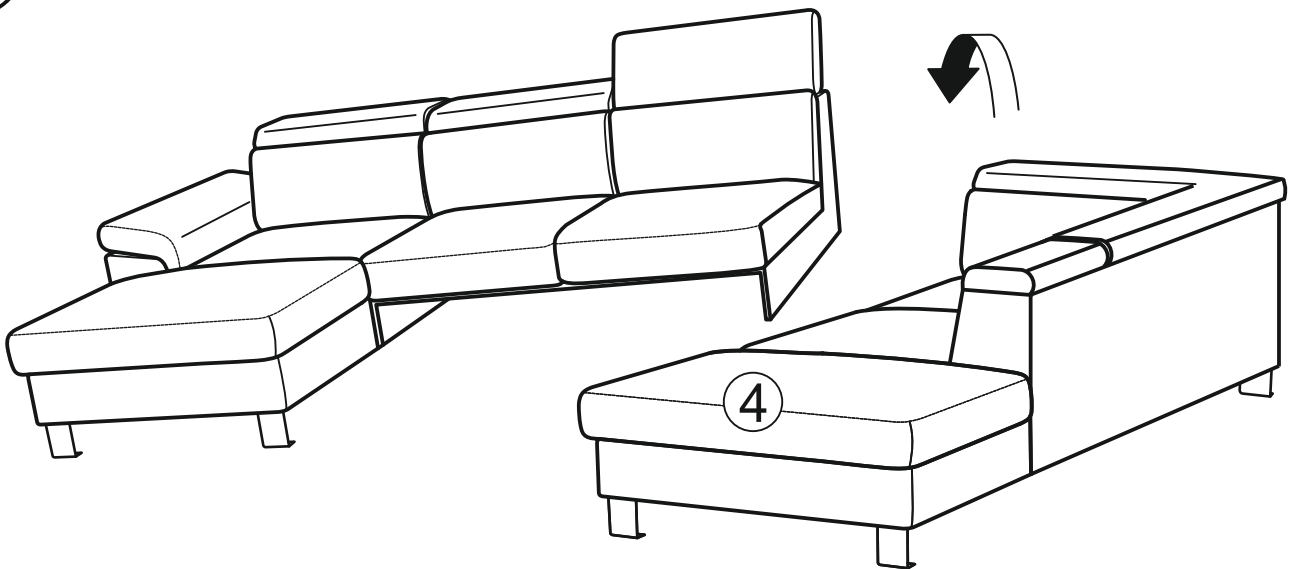

81

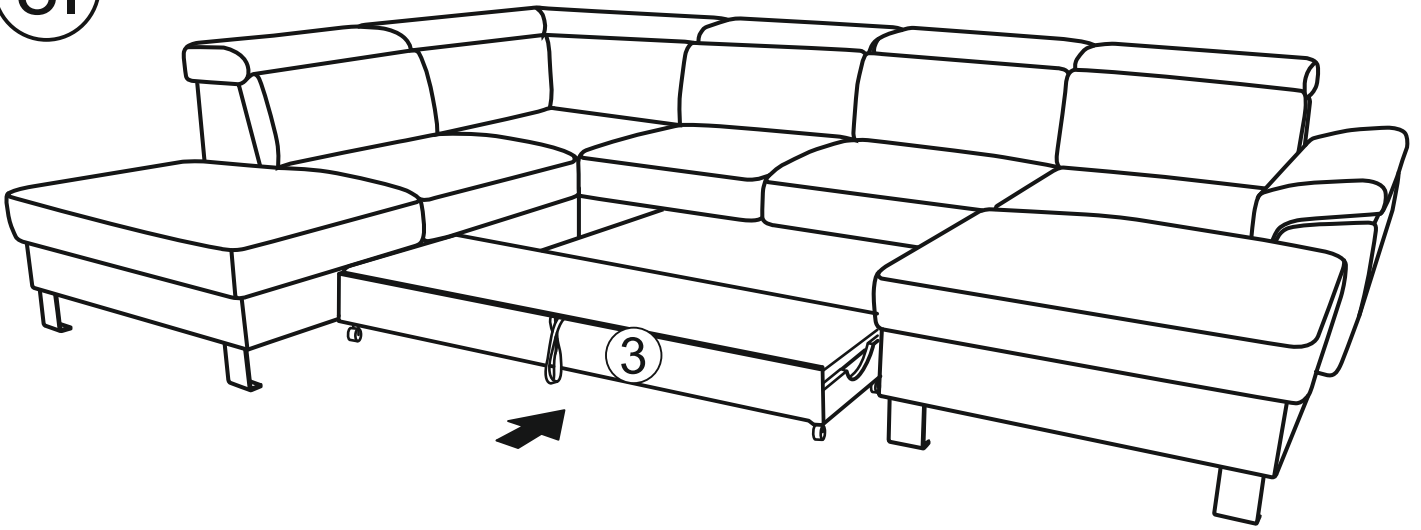

91

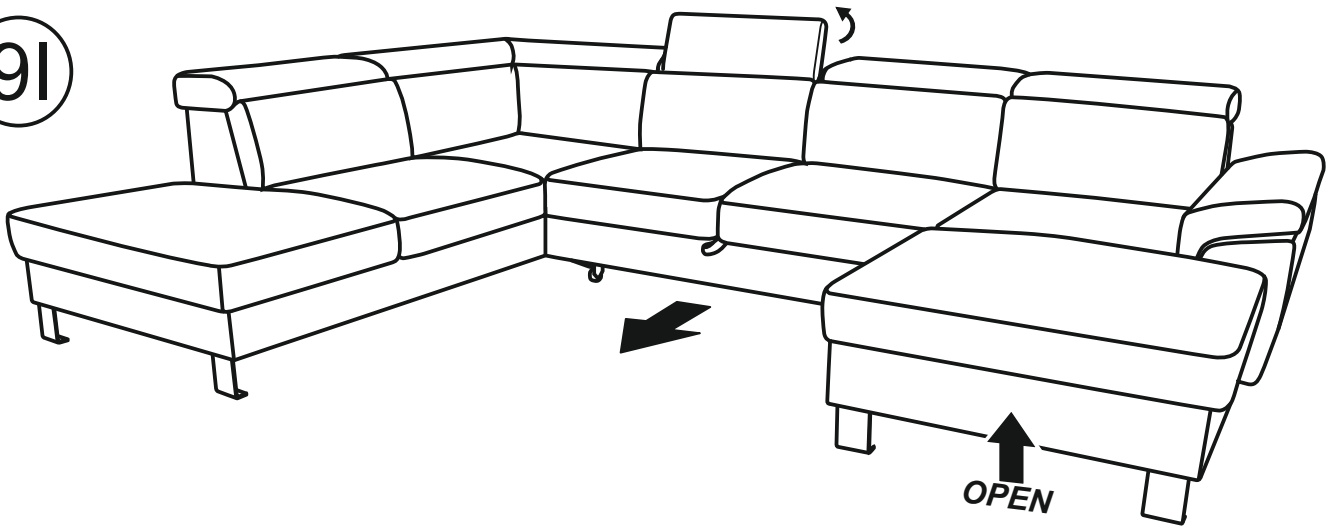

101

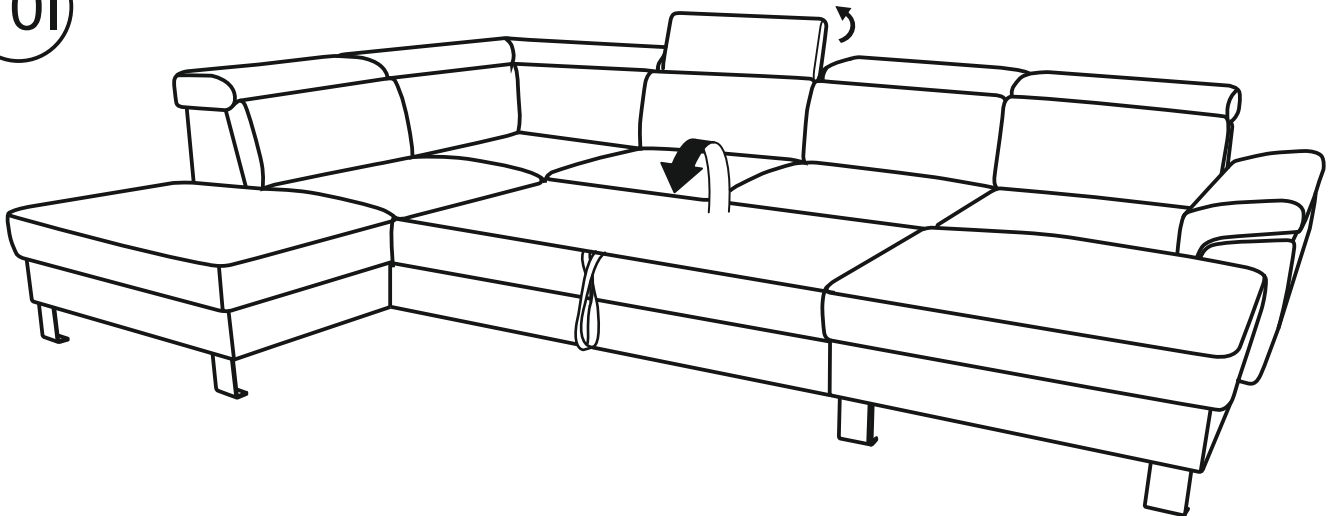

8II

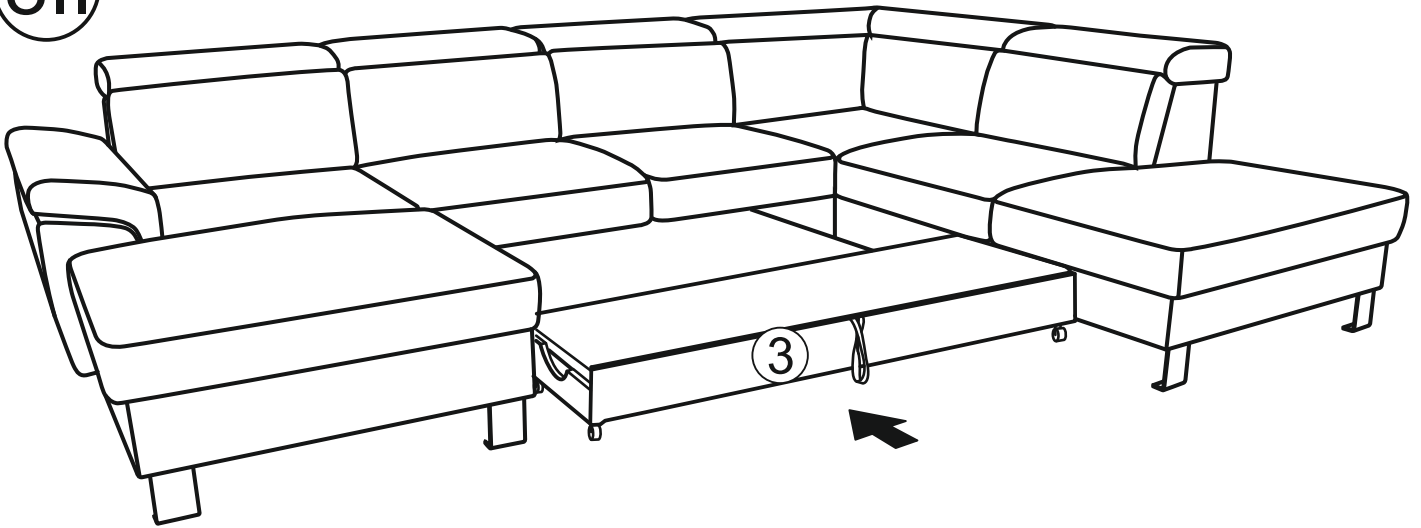

9II

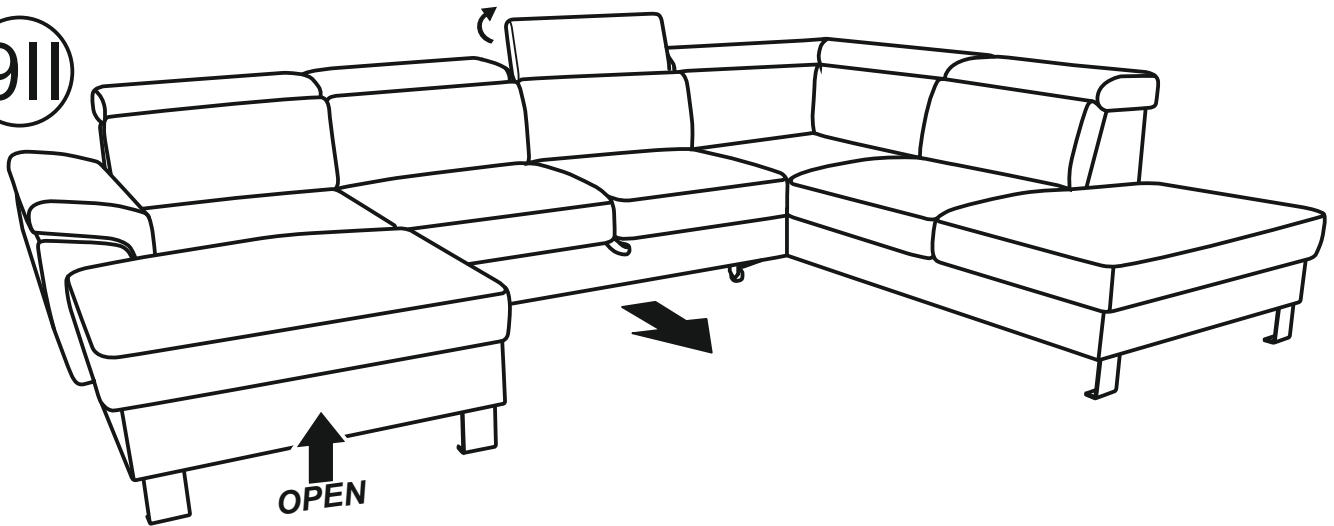

10II

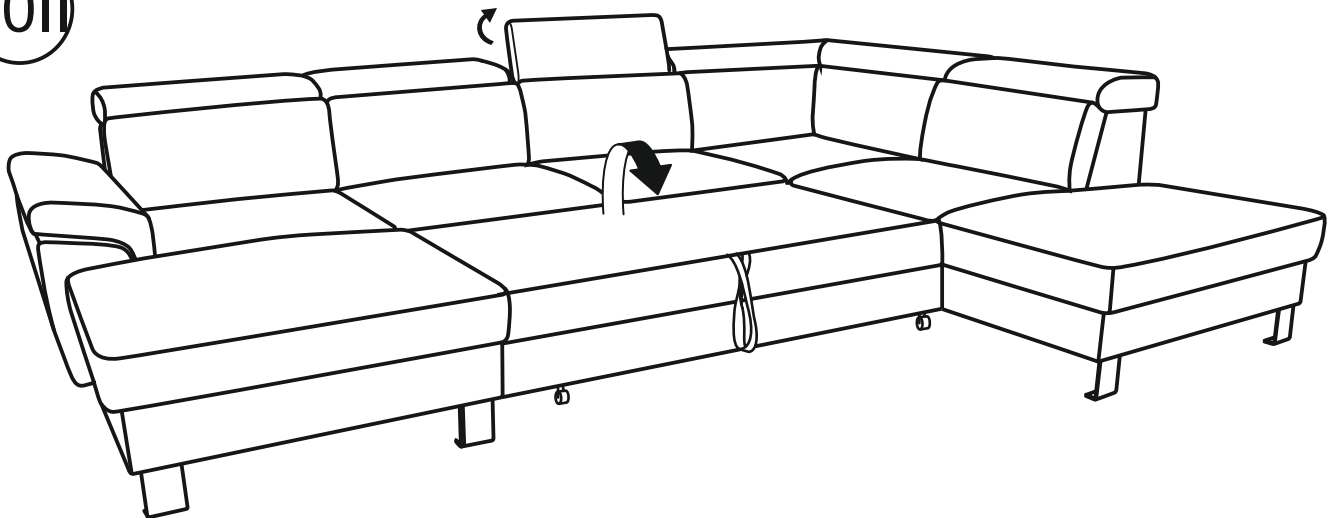

111

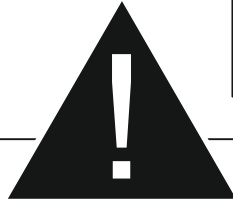
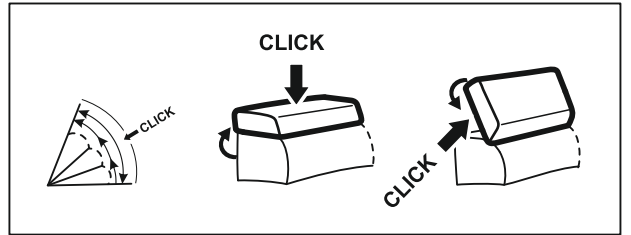
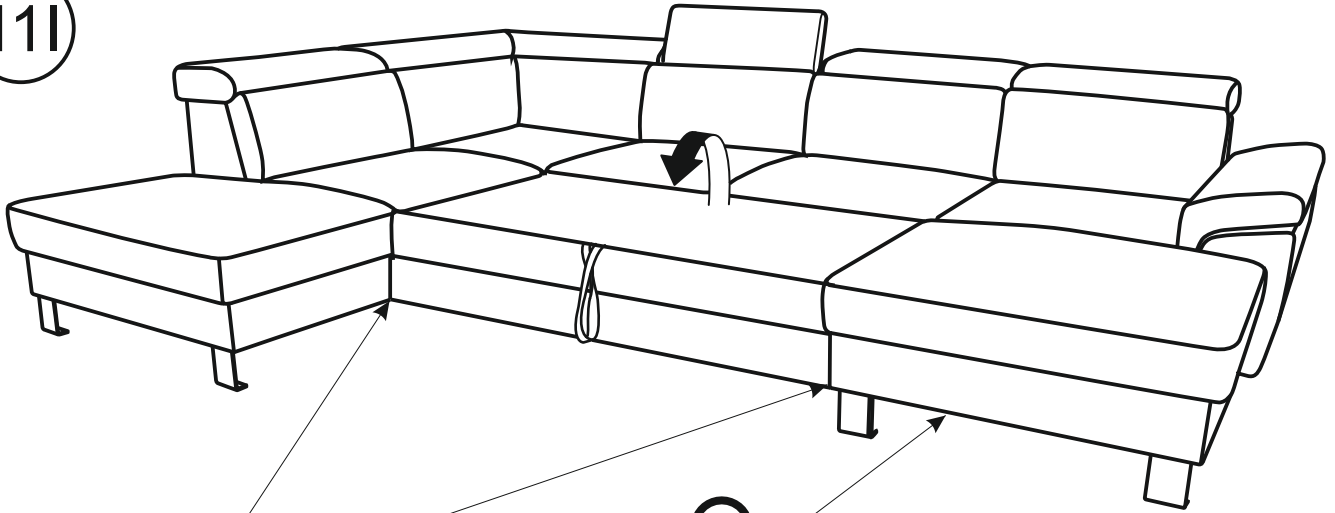

I

II

III

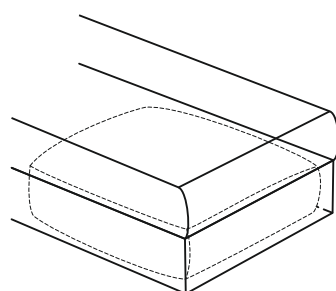
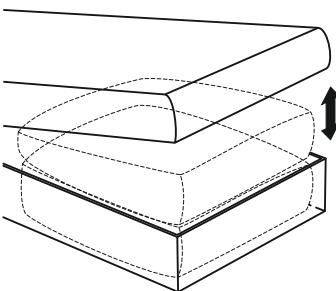
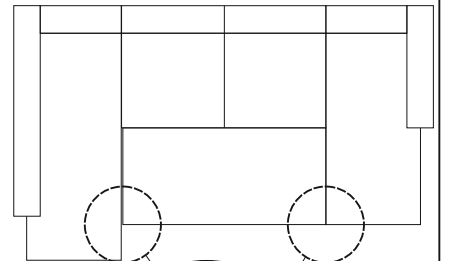
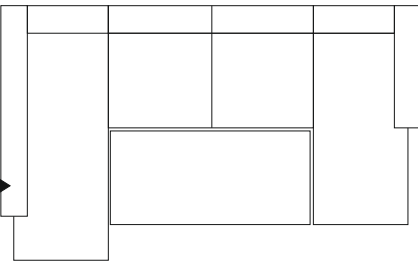
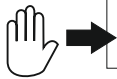
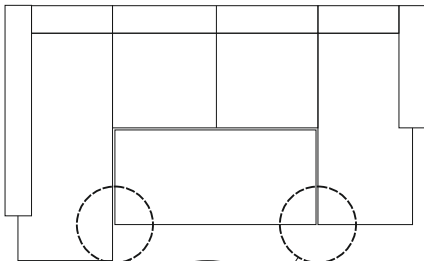

11 III

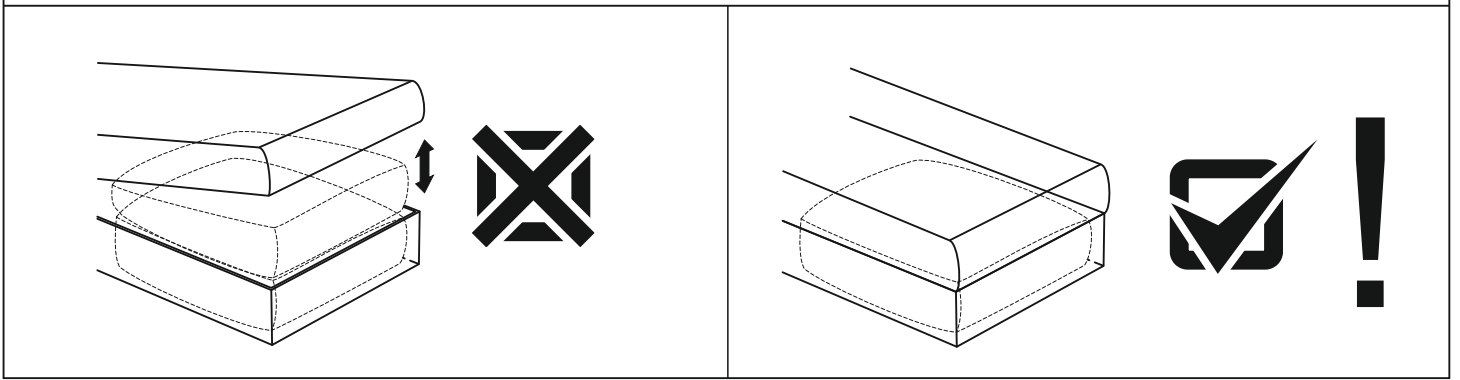
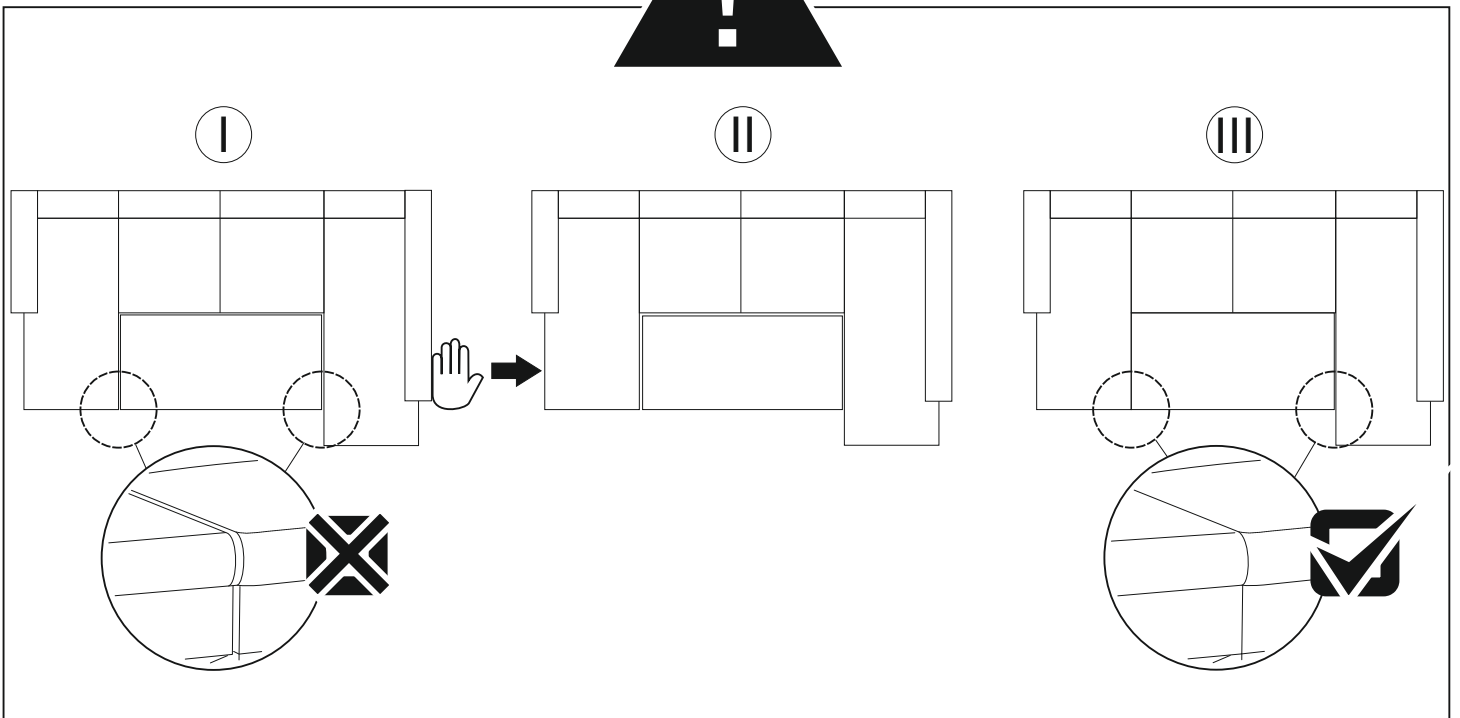
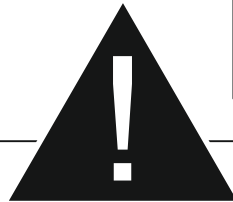
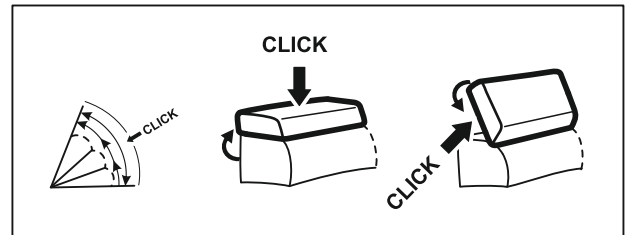
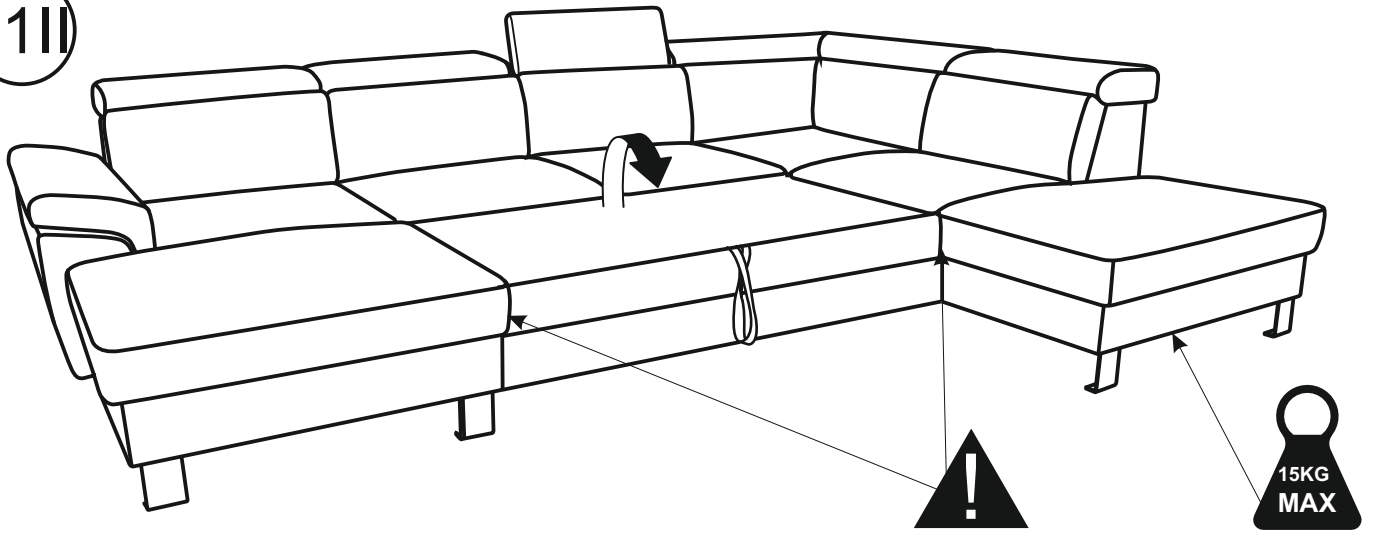

ACHTUNG!!!

