

A

S643-REGN/213/40

CONNECT

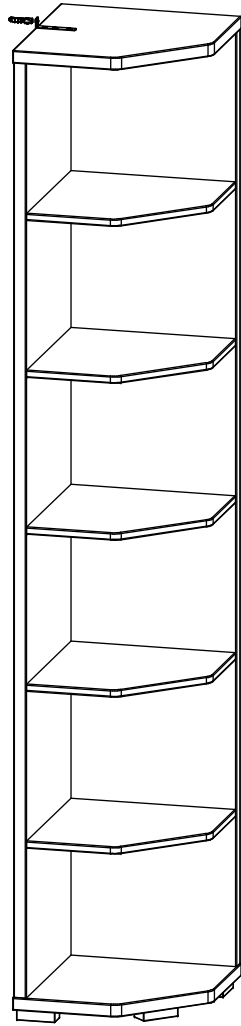

24270215/09
24270215/10

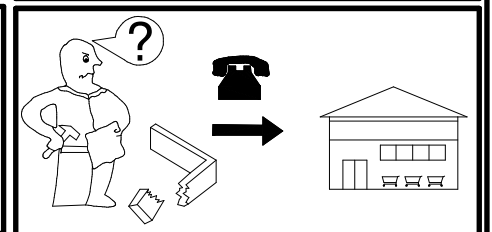
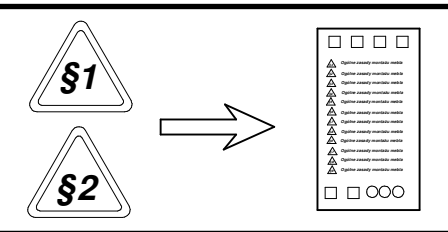
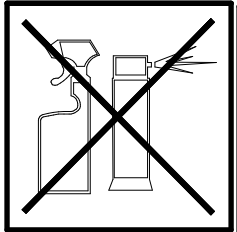
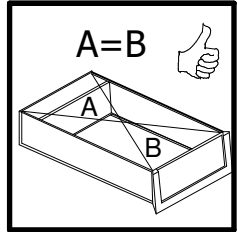
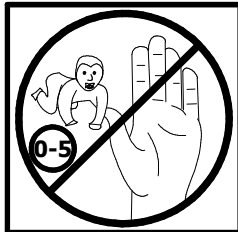
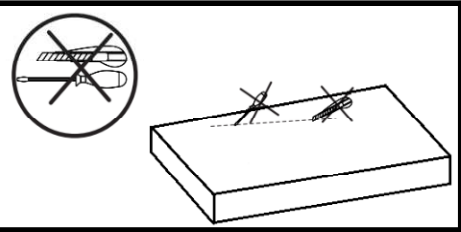
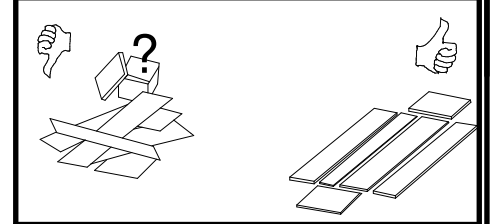
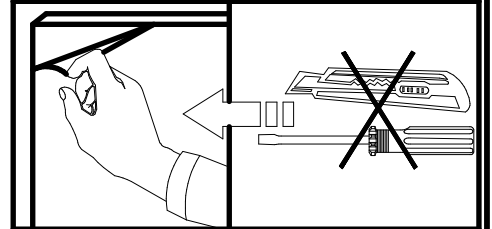
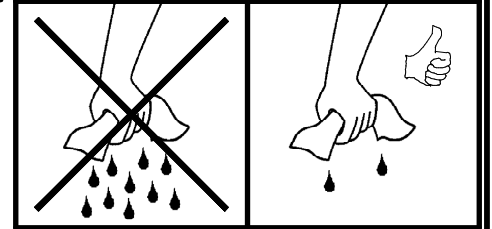
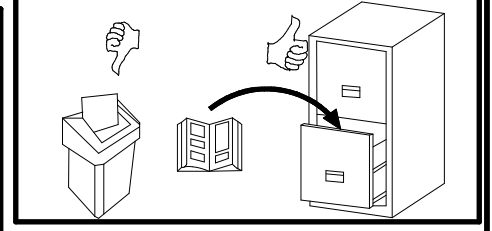
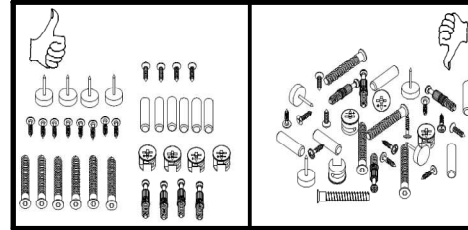
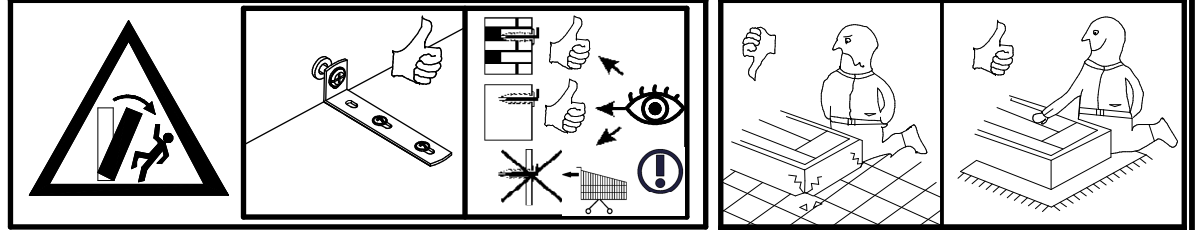

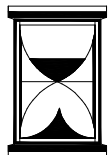
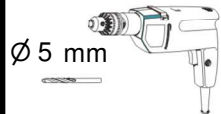
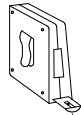
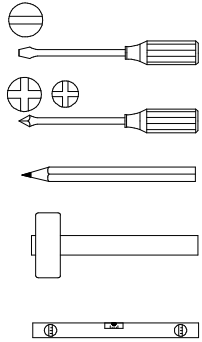
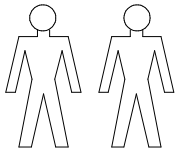

45 min

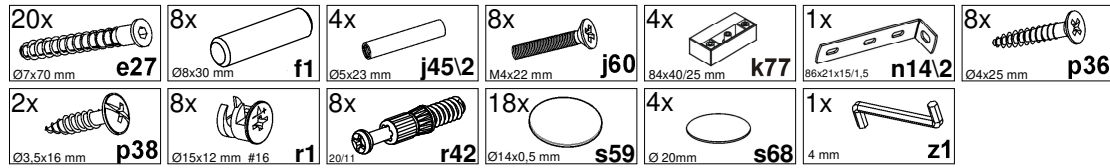

A	B1	B2	C1	C2	C3	D
1	S643-1005	-	2048	393	28	1/2
2	S643-1006	-	2048	363	28	1/2
3	S643-2007	-	395	395	28	2/2
4	S643-2008	-	395	395	28	2/2
5	S643-3003	-	361	363	16	2/2

A

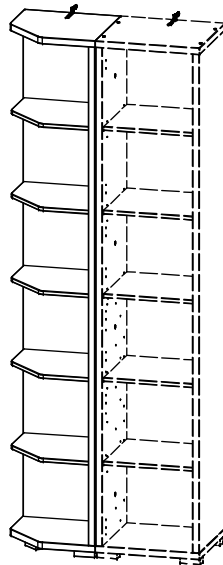

B

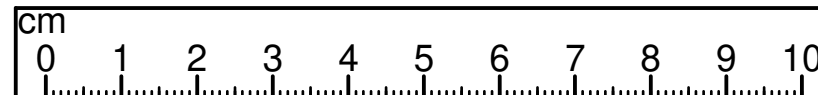
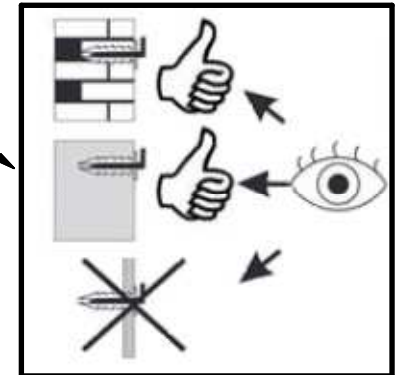
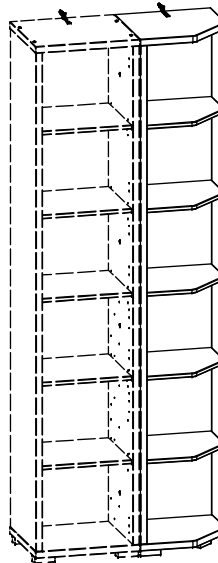

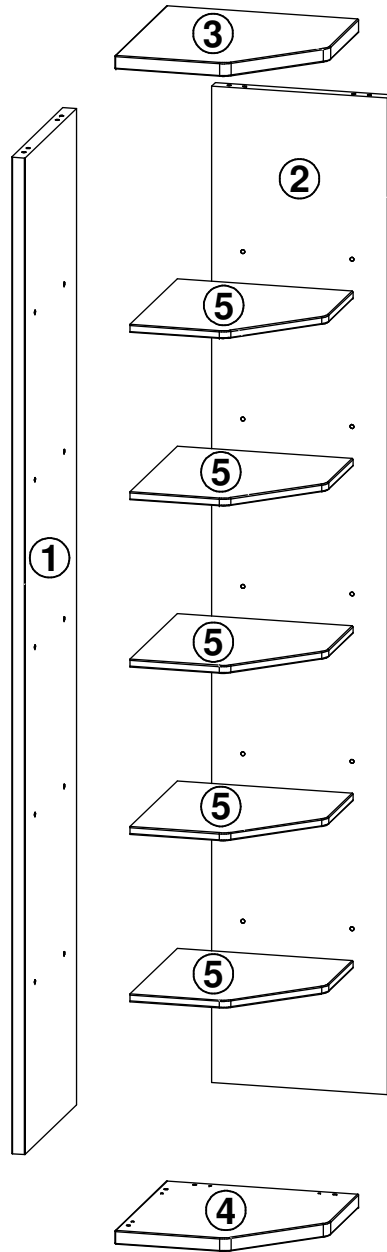

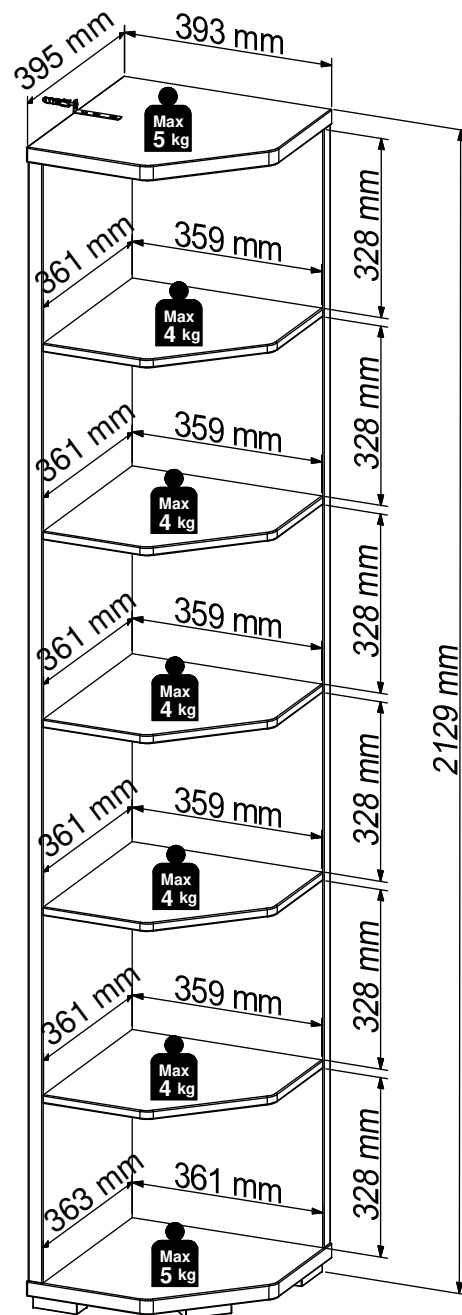

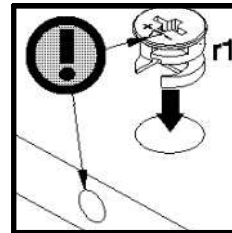
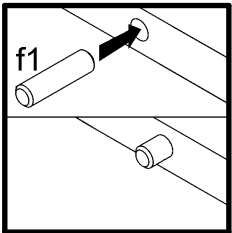
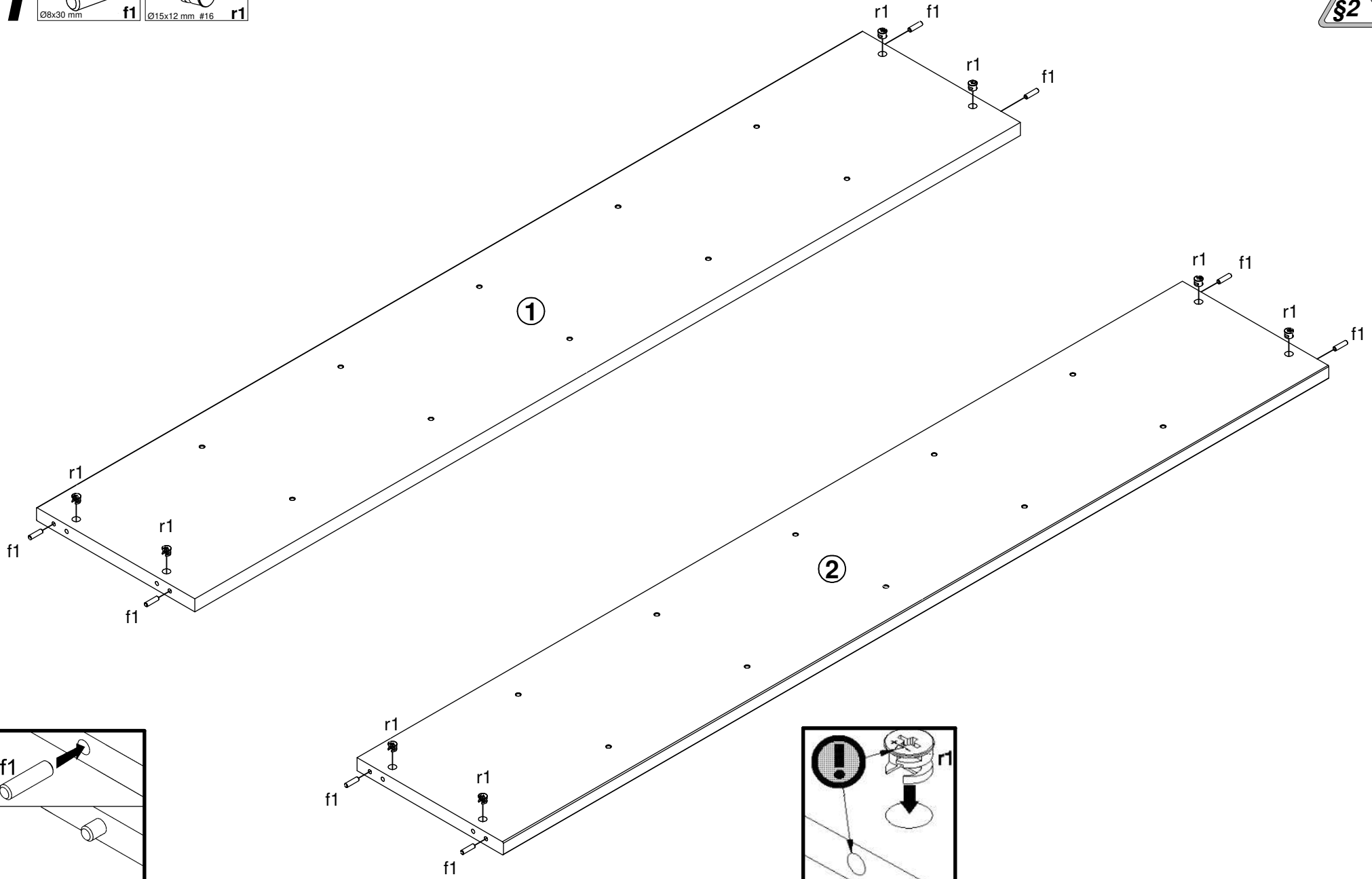
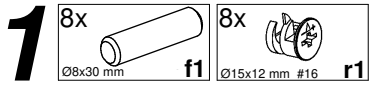

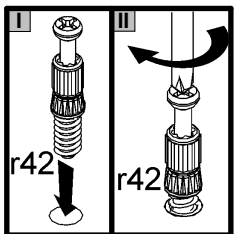
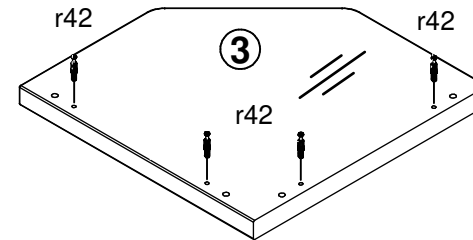
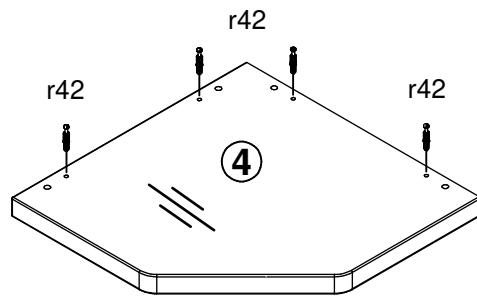
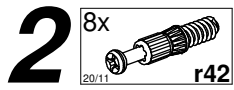

3

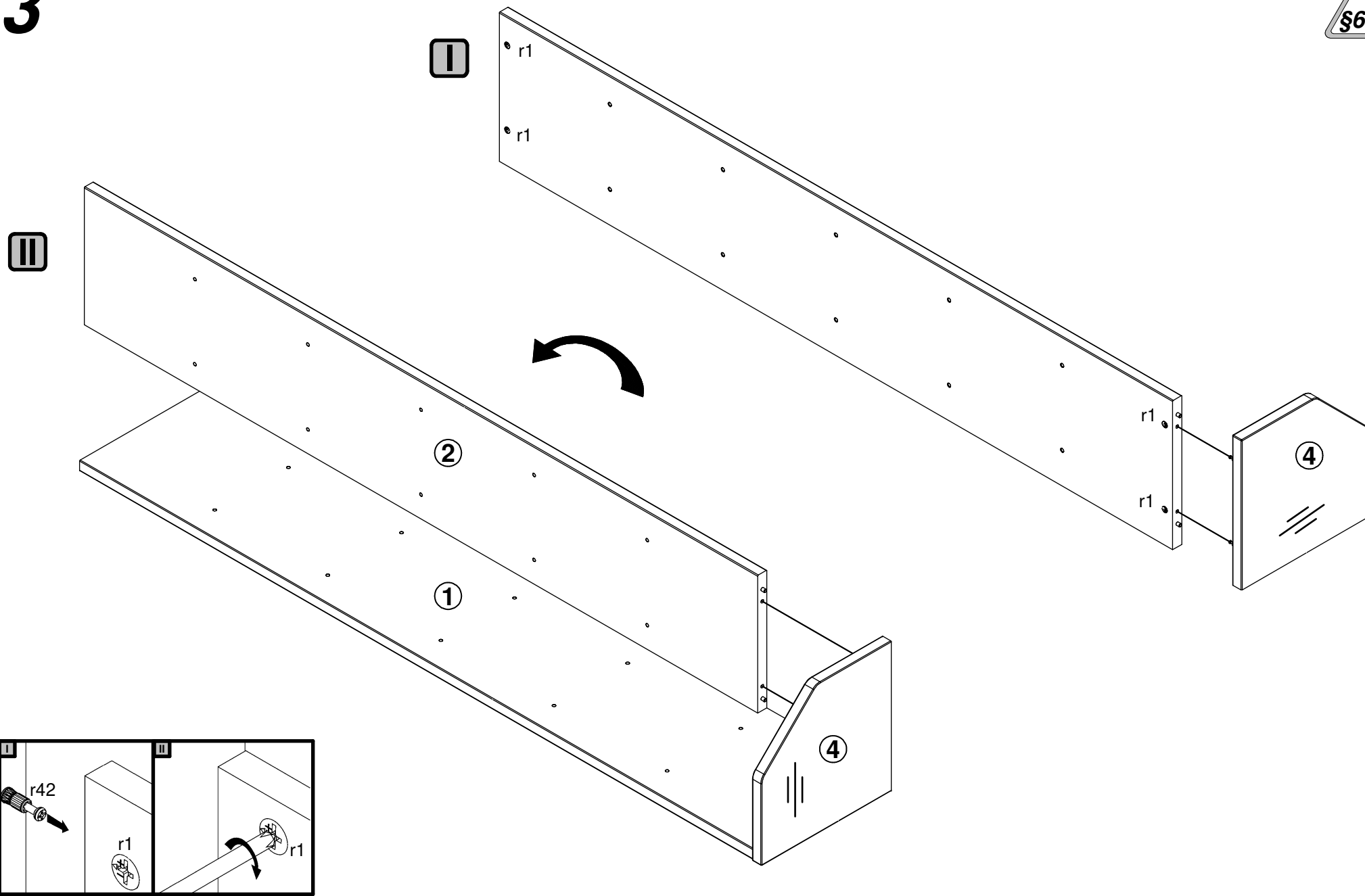

4

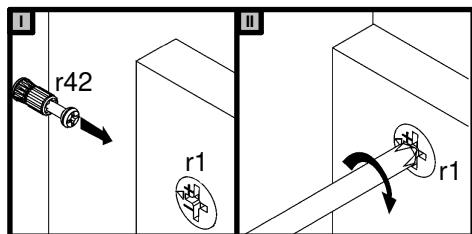
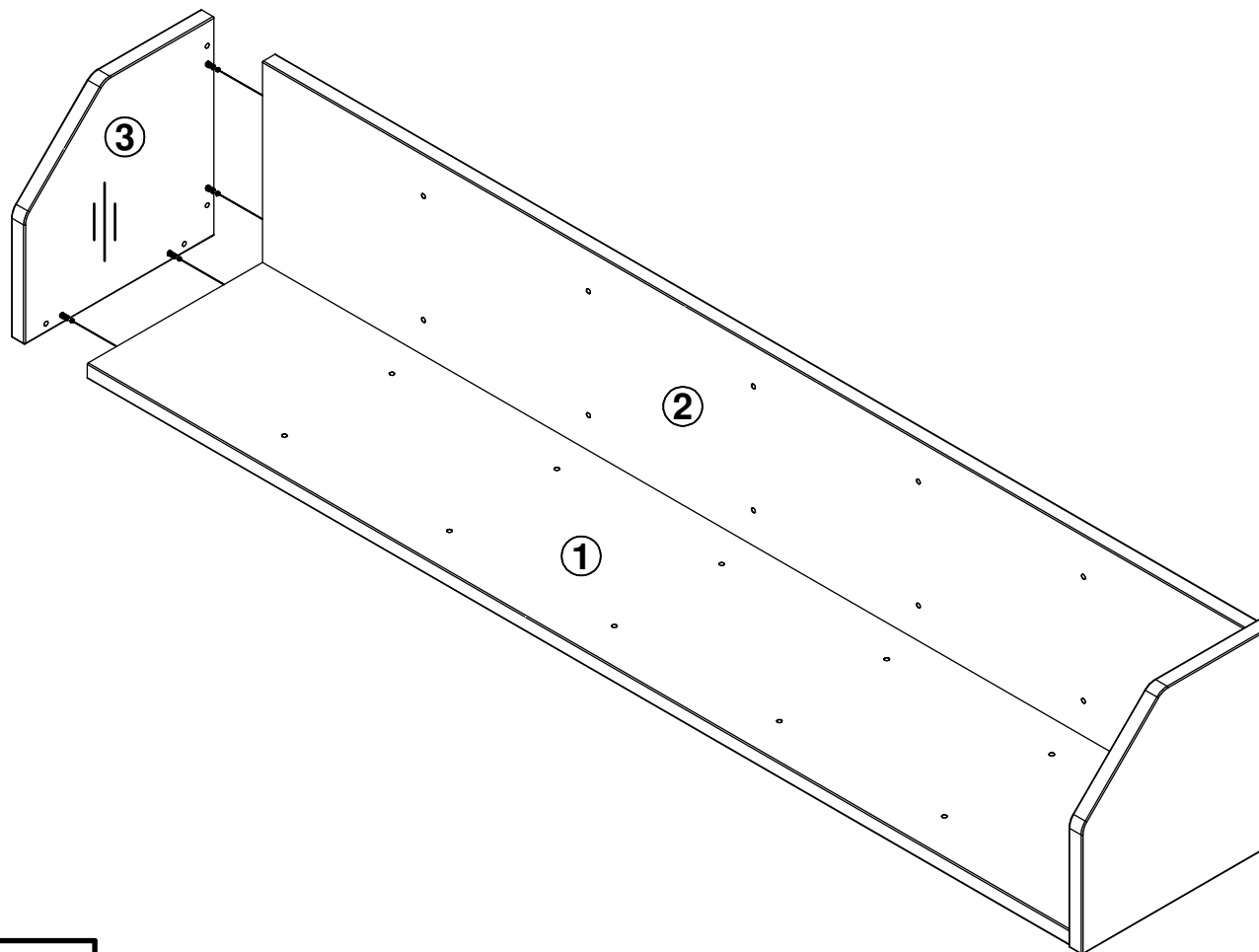

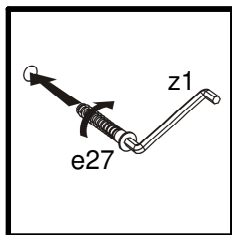
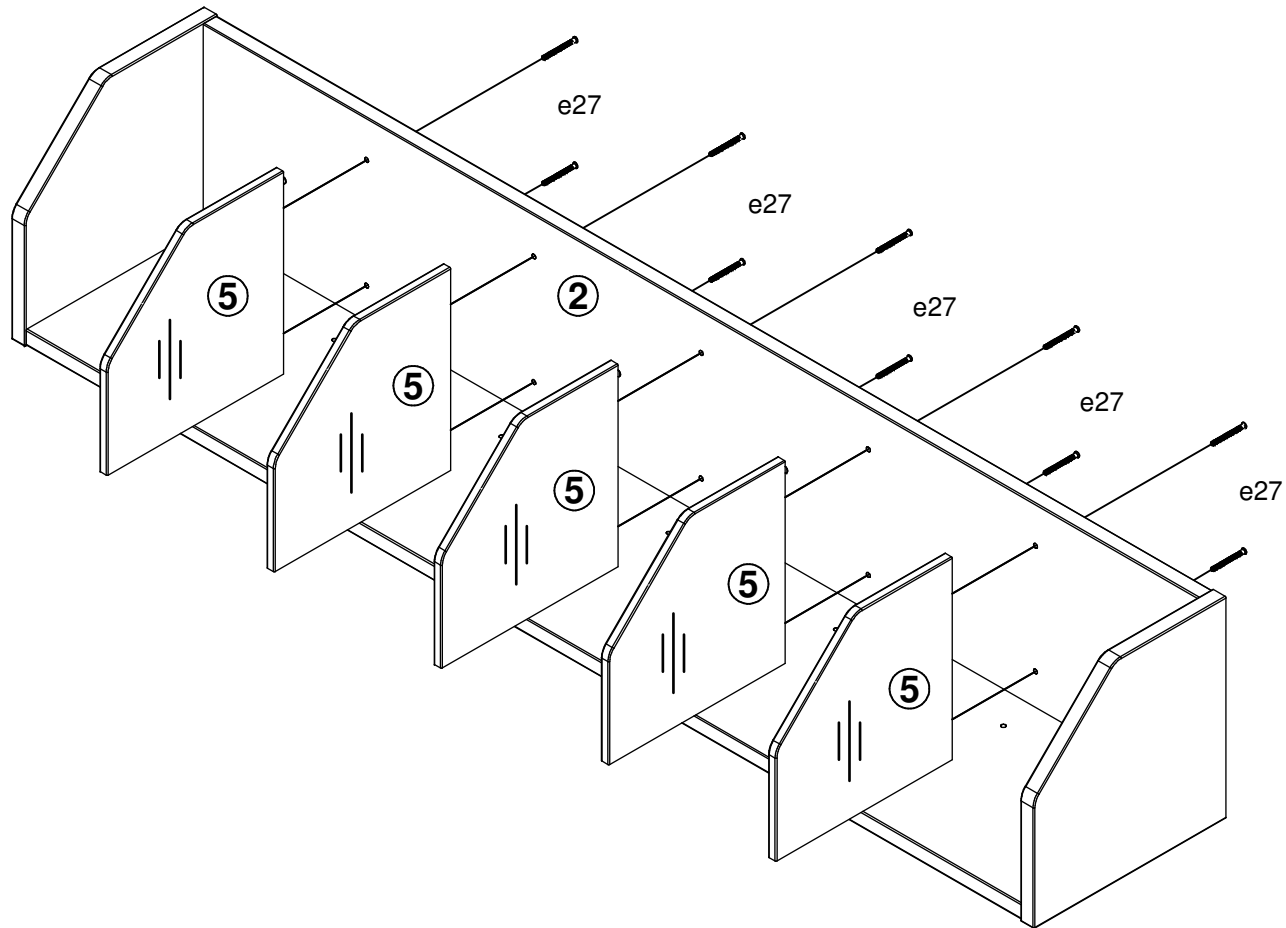
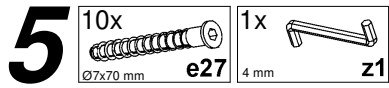

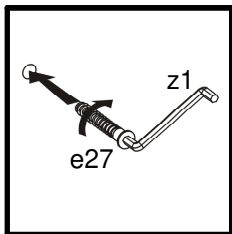
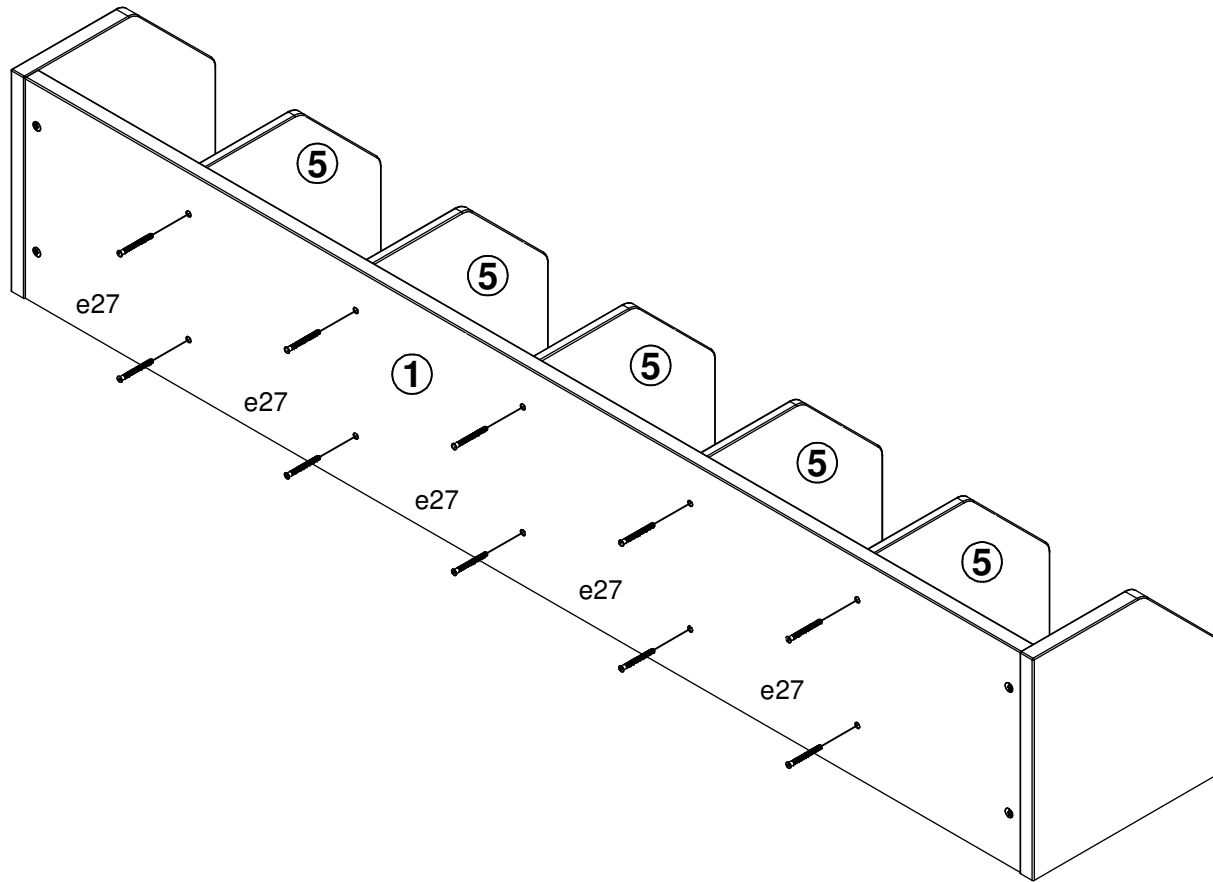
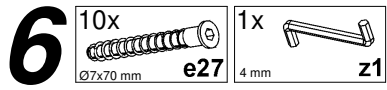

7A

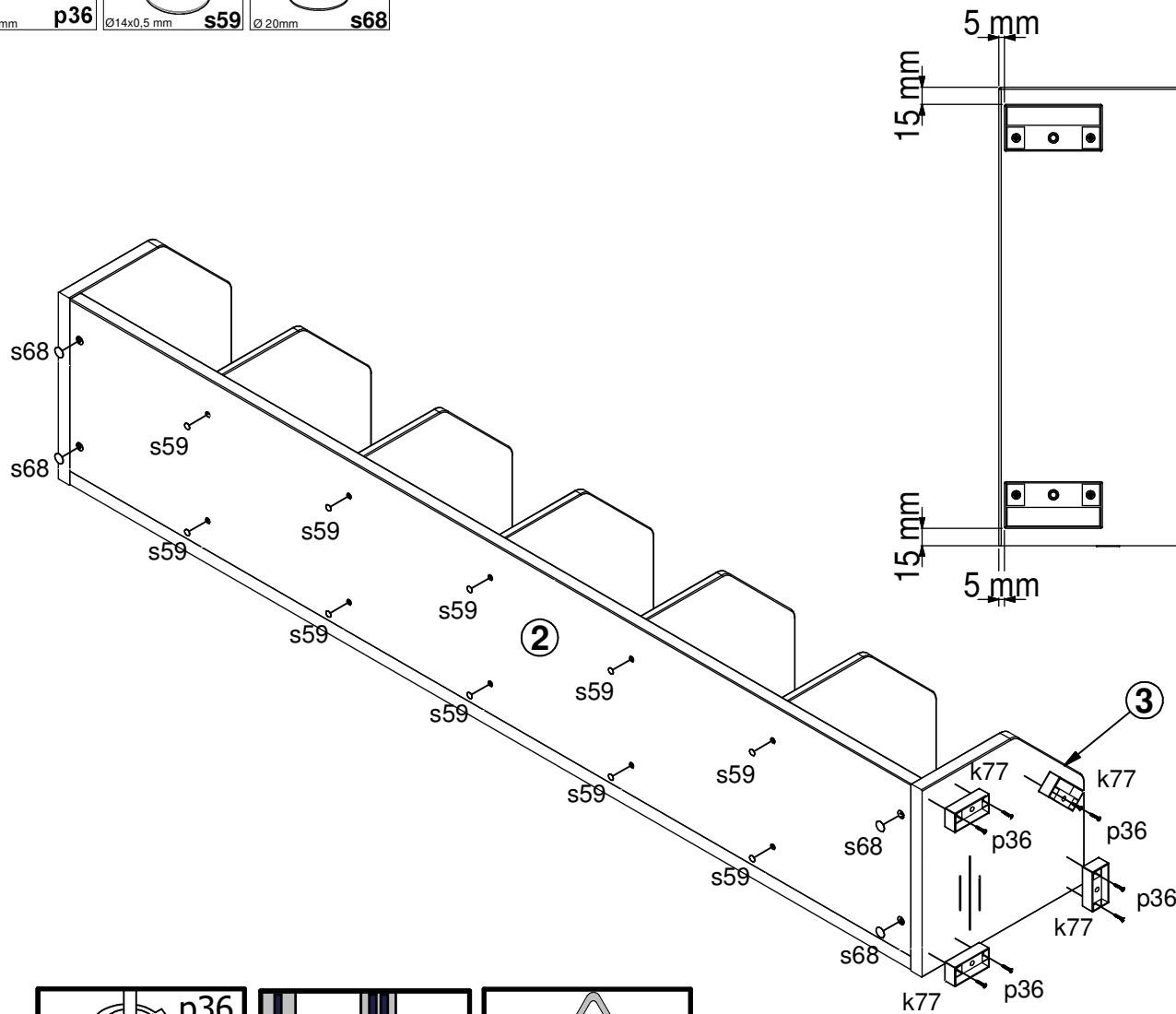
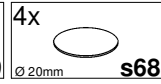
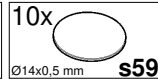
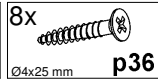
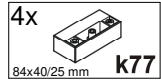

A

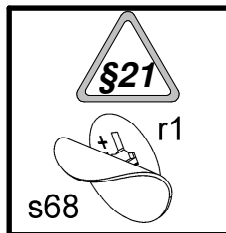
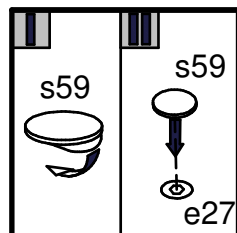
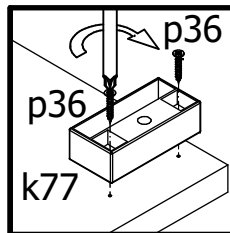
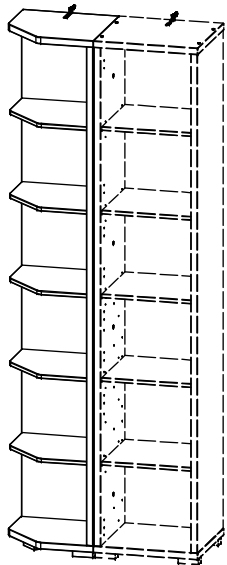

8A

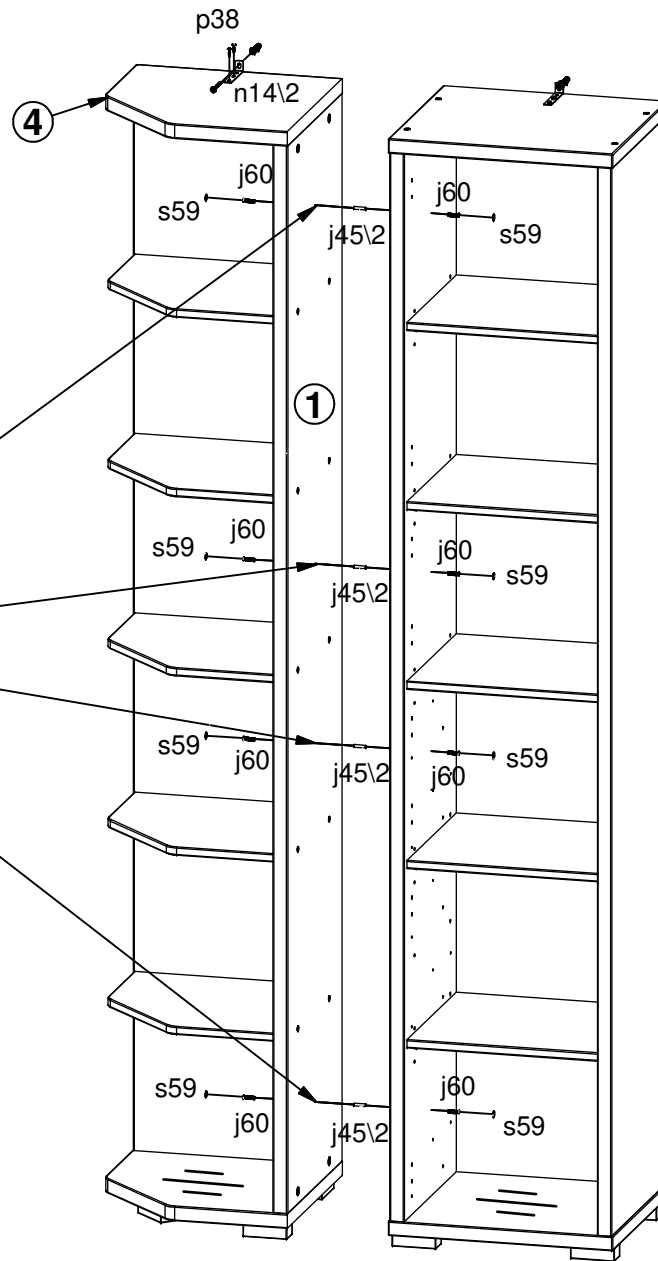
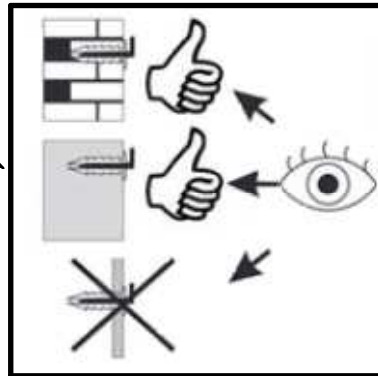
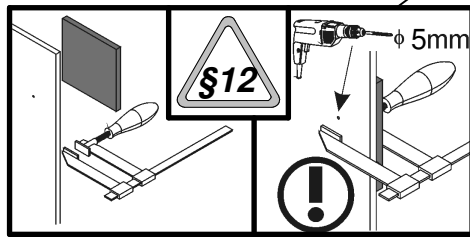
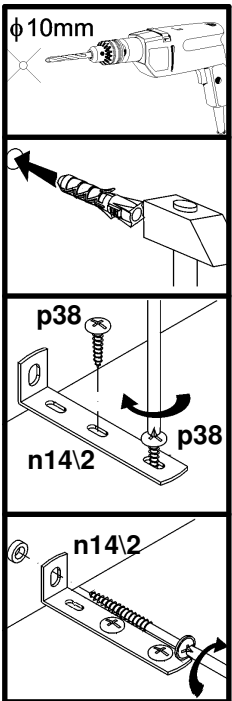
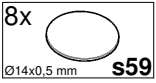
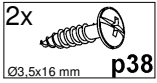
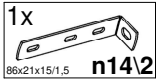
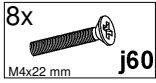
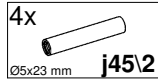

7B

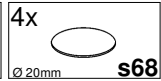
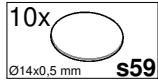
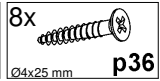
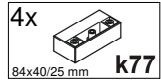

B

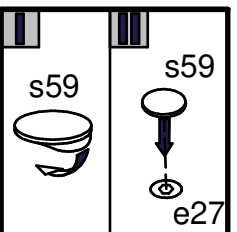
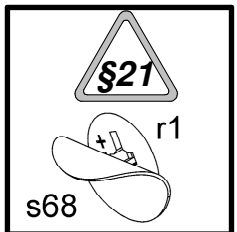
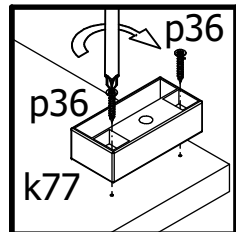
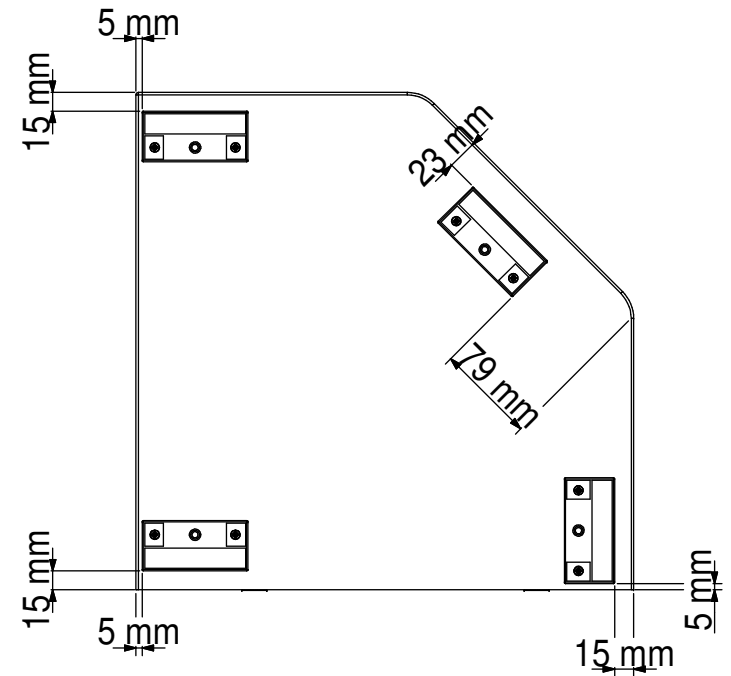
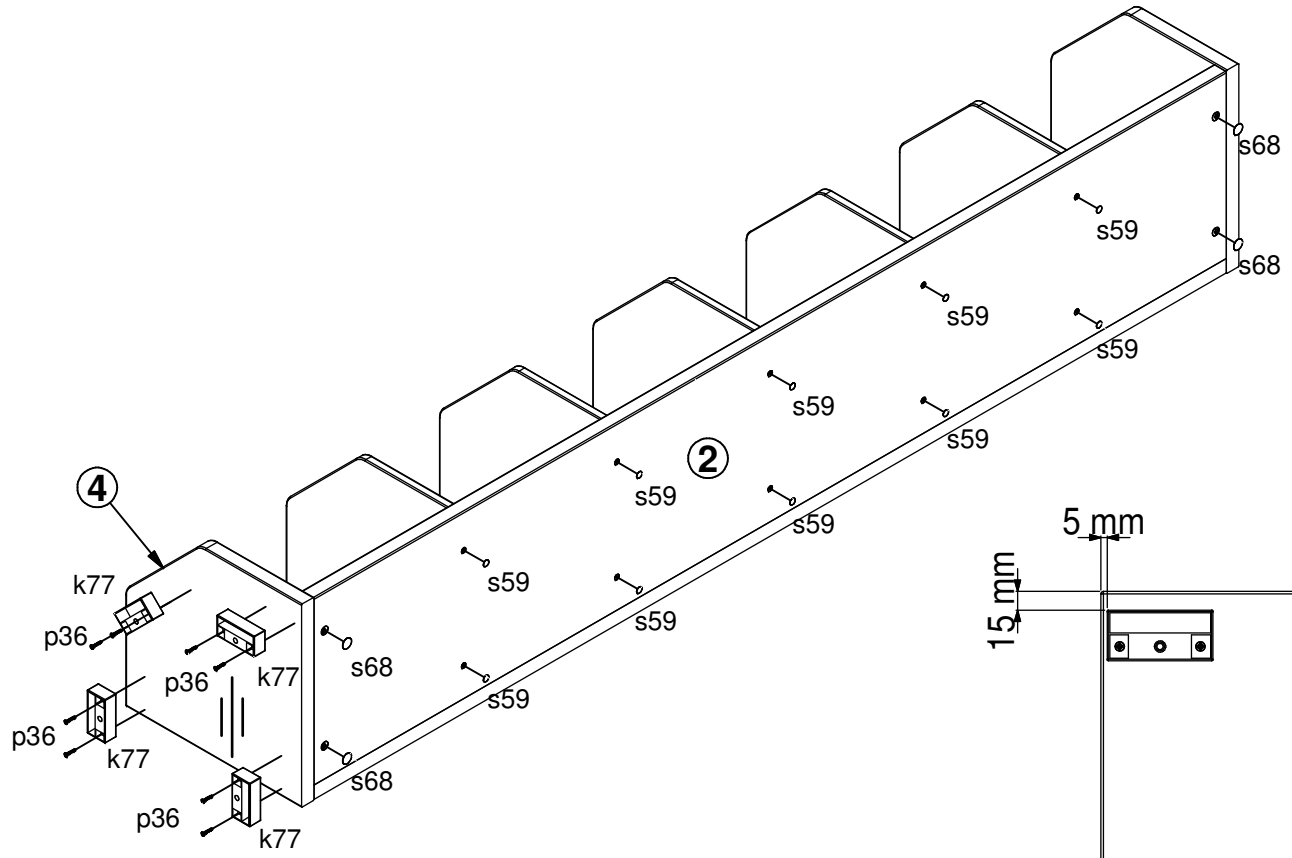
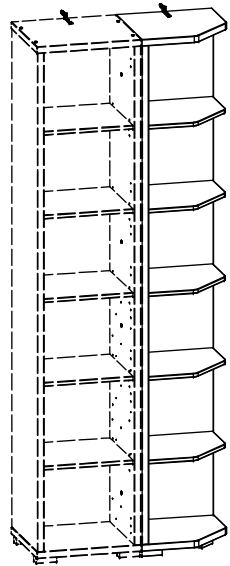

8B

