

| | | 1/3 | | |
|----|------|------|----|----|
| | | B | H | T |
| 1 | 381 | 356 | 16 | x1 |
| 9 | 576 | 356 | 16 | x1 |
| 4 | 1152 | 375 | 28 | x1 |
| 11 | 375 | 541 | 16 | x1 |
| 6 | 375 | 1117 | 16 | x1 |
| 3 | 381 | 338 | 16 | x1 |

| | | 2/3 | | |
|----|------|------|----|----|
| | | B | H | T |
| 13 | 300 | 100 | 12 | x1 |
| 14 | 300 | 100 | 12 | x1 |
| 17 | 501 | 305 | 3 | x1 |
| 16 | 192 | 541 | 16 | x1 |
| 7 | 397 | 1122 | 3 | x1 |
| 12 | 584 | 547 | 3 | x1 |
| 18 | 919 | 575 | 16 | x1 |
| 19 | 1523 | 575 | 16 | x1 |
| 15 | 84 | 491 | 16 | x1 |

| | | 3/3 | | |
|----|------|-----|----|----|
| | | B | H | T |
| 8 | 576 | 375 | 28 | x1 |
| 2 | 381 | 375 | 28 | x1 |
| 5 | 1152 | 375 | 28 | x1 |
| 10 | 576 | 375 | 28 | x1 |
| 20 | 574 | 260 | 28 | x1 |

| | | | | | |
|-------------|--------------|-------------|-------------|---------------|------|
| | | | | | |
| ZM1A 20 | ZM1B 16 | ZM1 8 | ZM2 6 | ZWP1 5 | PP 2 |
| | | | | | |
| W13 4x50 2 | W9 4x40 2 | W7 4x30 6 | W6 4x20 5 | W4 4x13 10 | |
| | | | | | |
| W1 3x16 8 | W11 3,5x16 4 | WV1 3 | TPP3 3 | SS3 5 | |
| | | | | | |
| S1 10 | PQ4 L-300 1 | PQ3 L-300 1 | KRW2 6x30 2 | KD2 8x60 5 | |
| | | | | | |
| KT1 8x35 20 | K2 7x70 14 | K1 7x50 1 | KK1 1 | MZM1A 12x12 2 | |
| | | | | | |
| WG3 1 | WU 3,5x27 6 | U56 3 | SG1 2 | KM1 5x42 2 | |

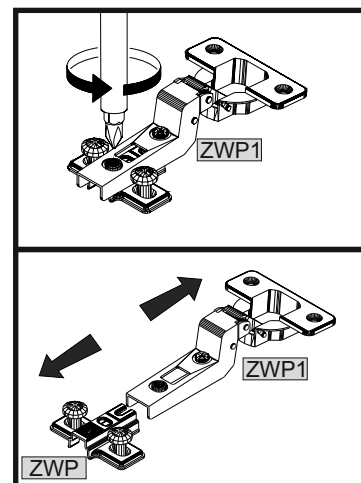

01

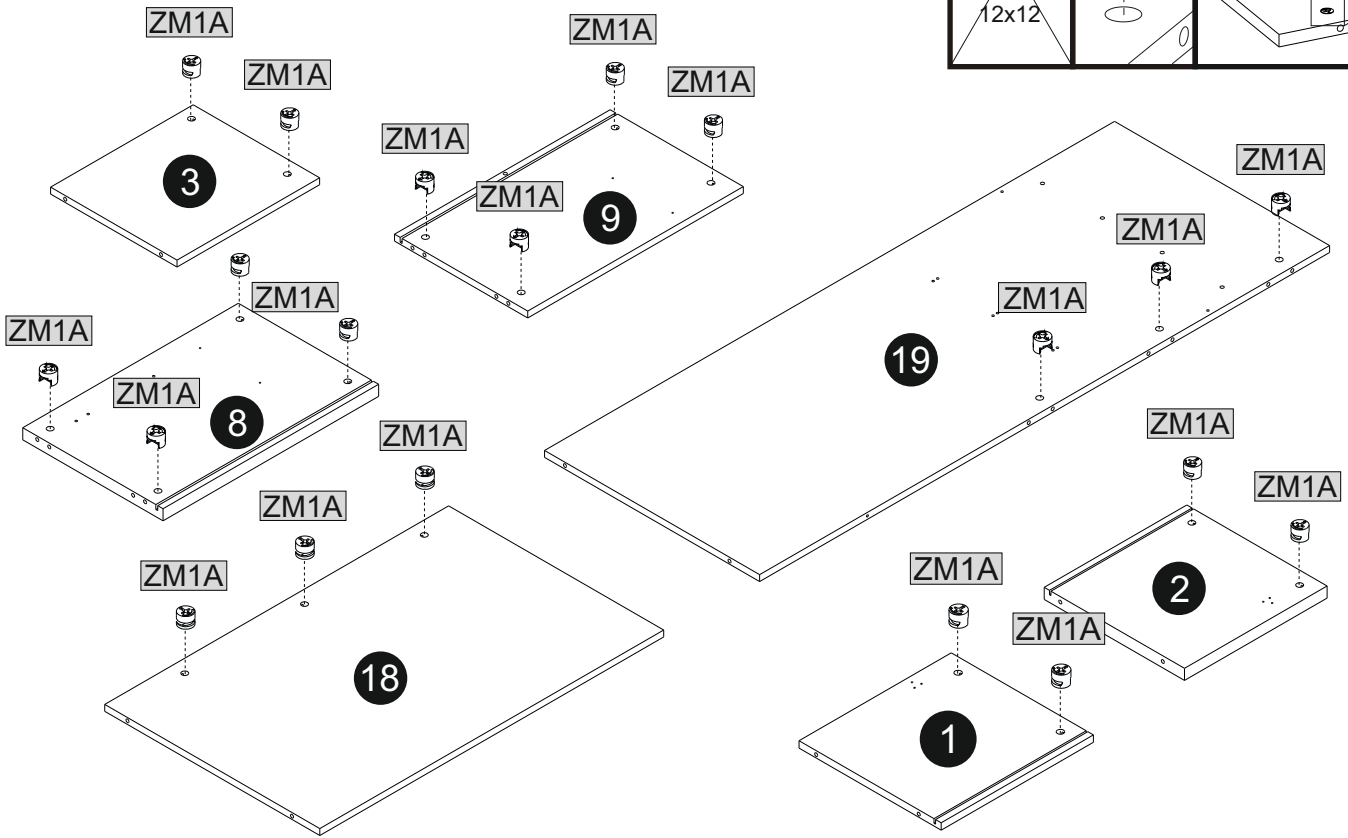
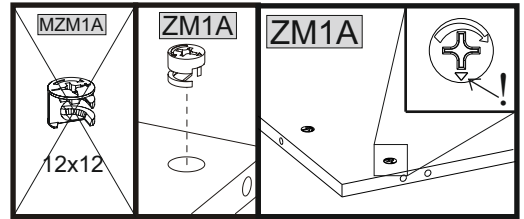
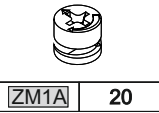
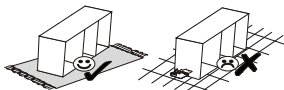

02

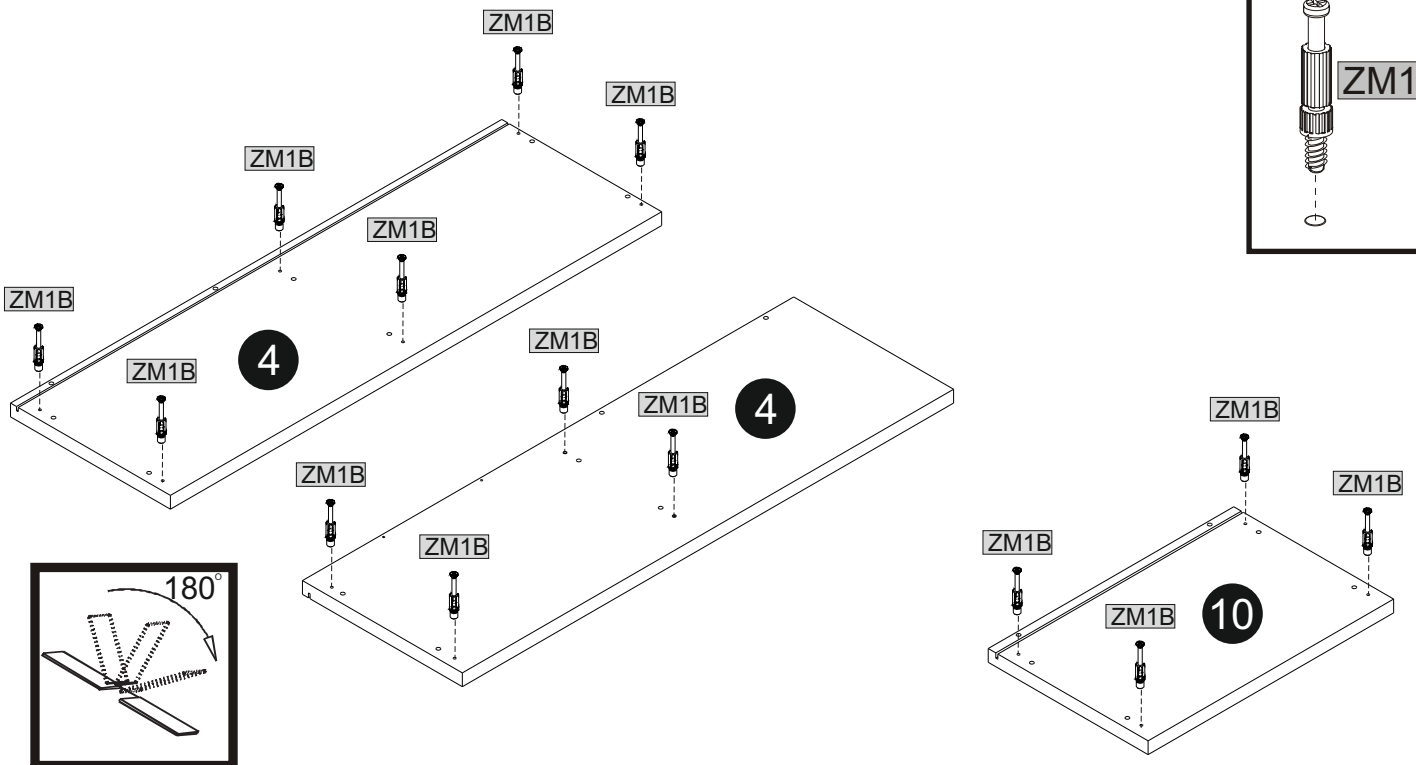
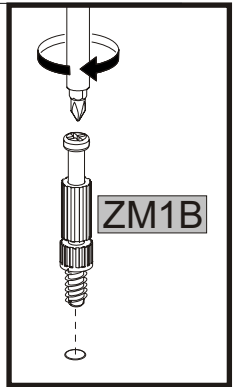
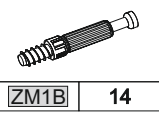
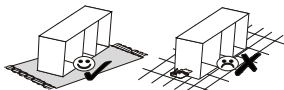

03

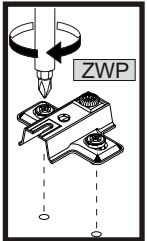
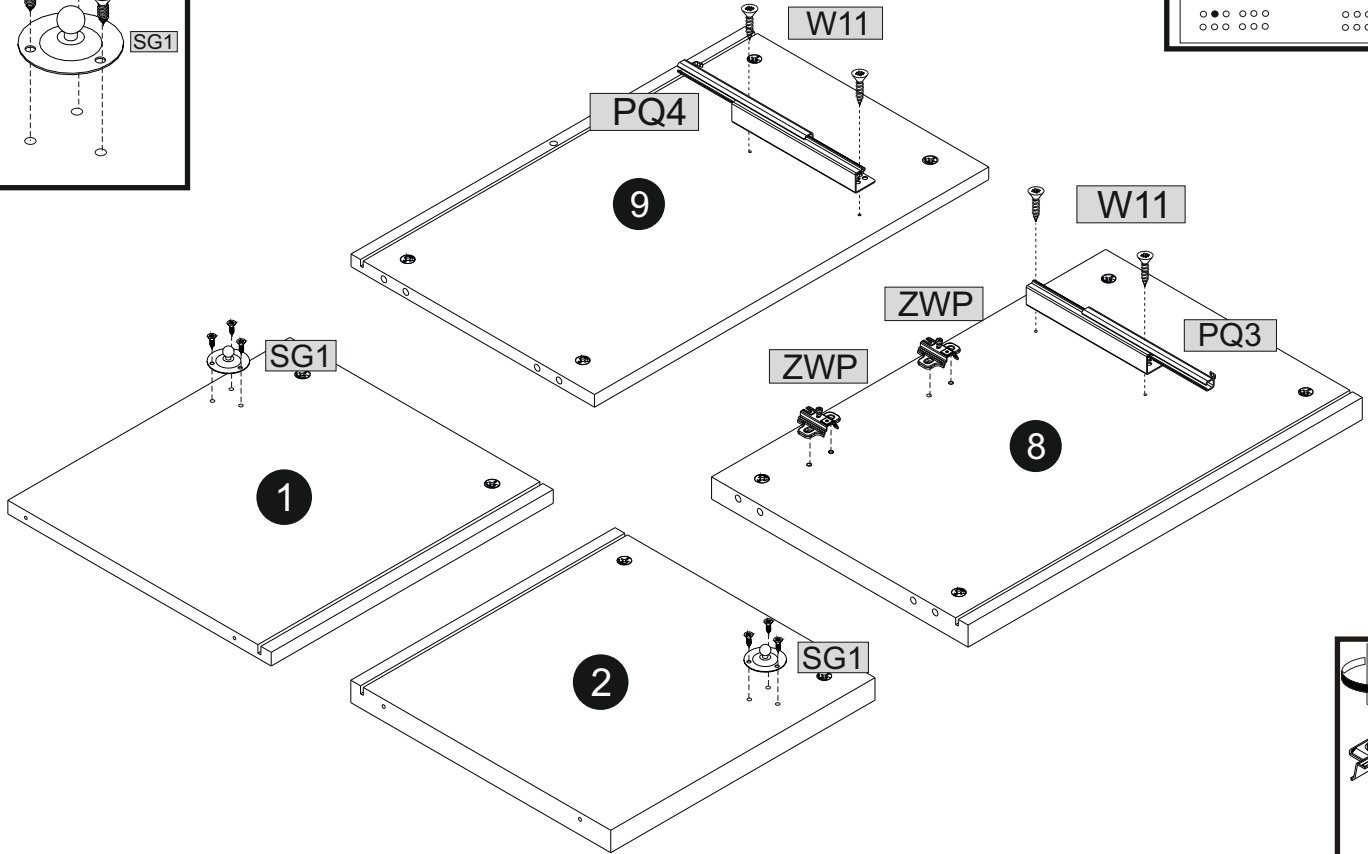
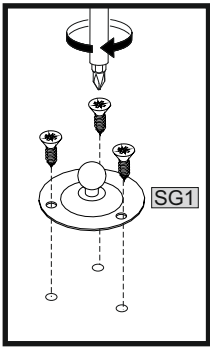
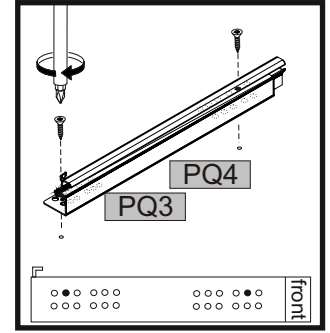
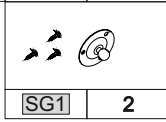
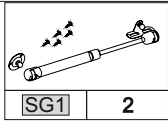
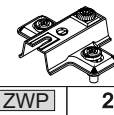
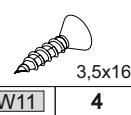
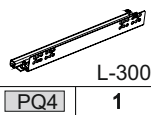
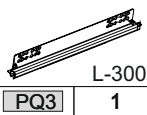
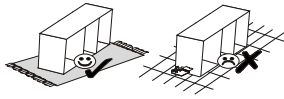

04

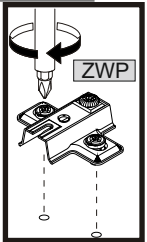
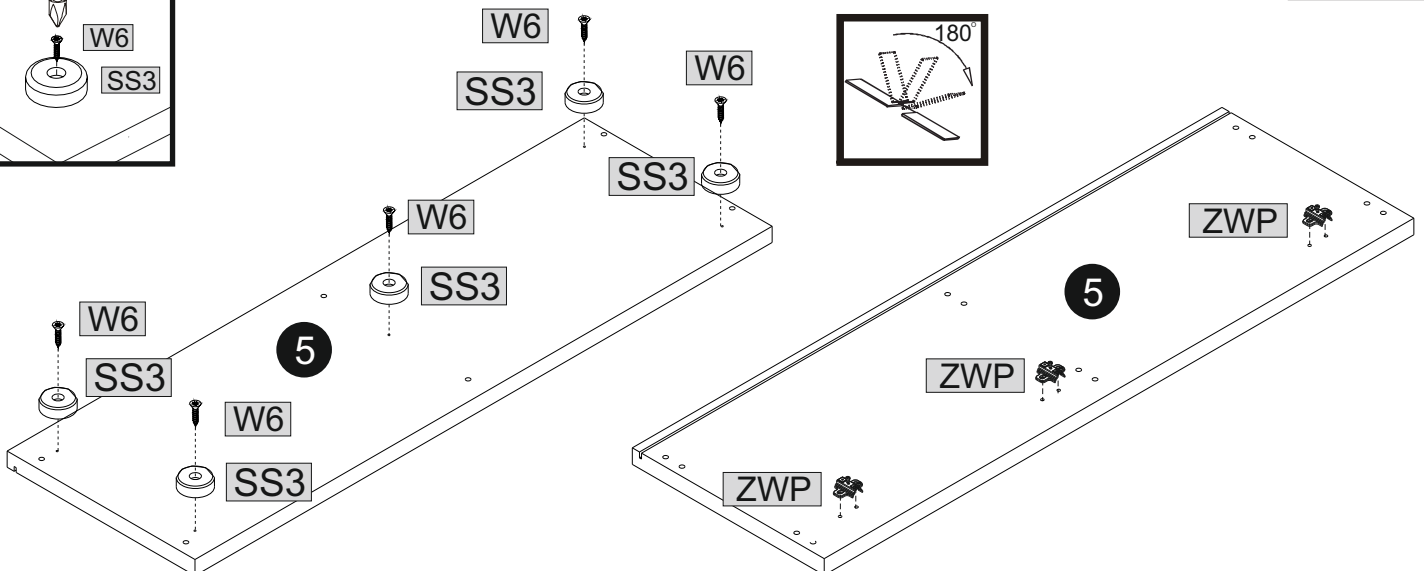
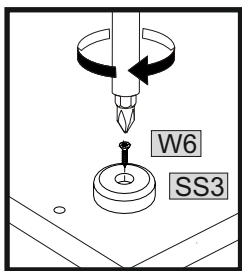
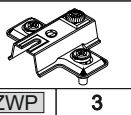
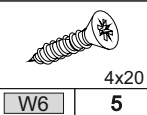
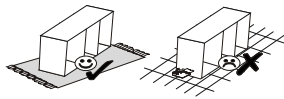

05

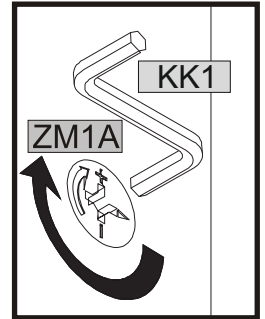
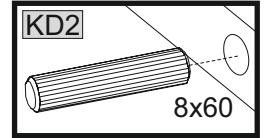
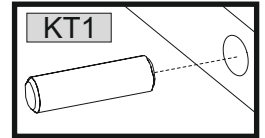
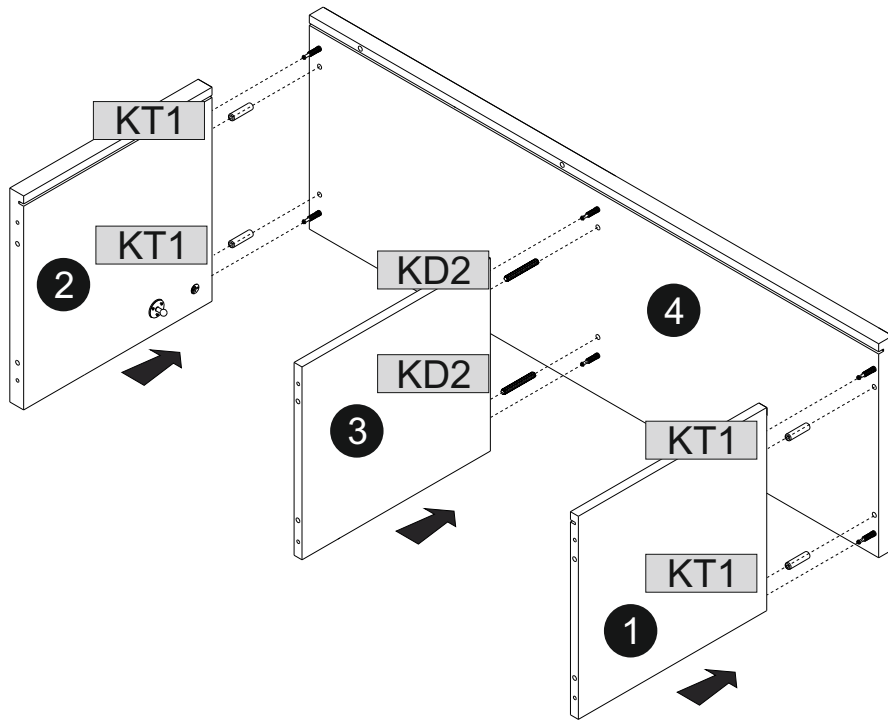
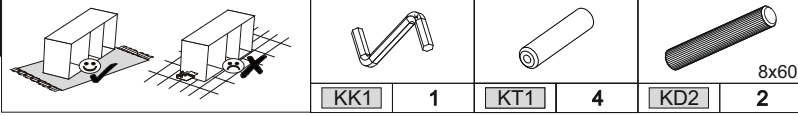

06

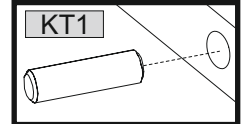
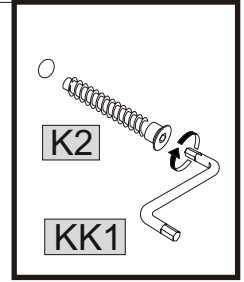
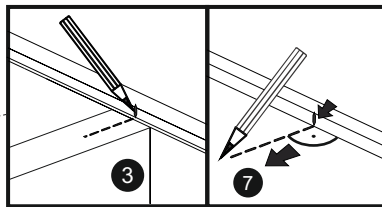
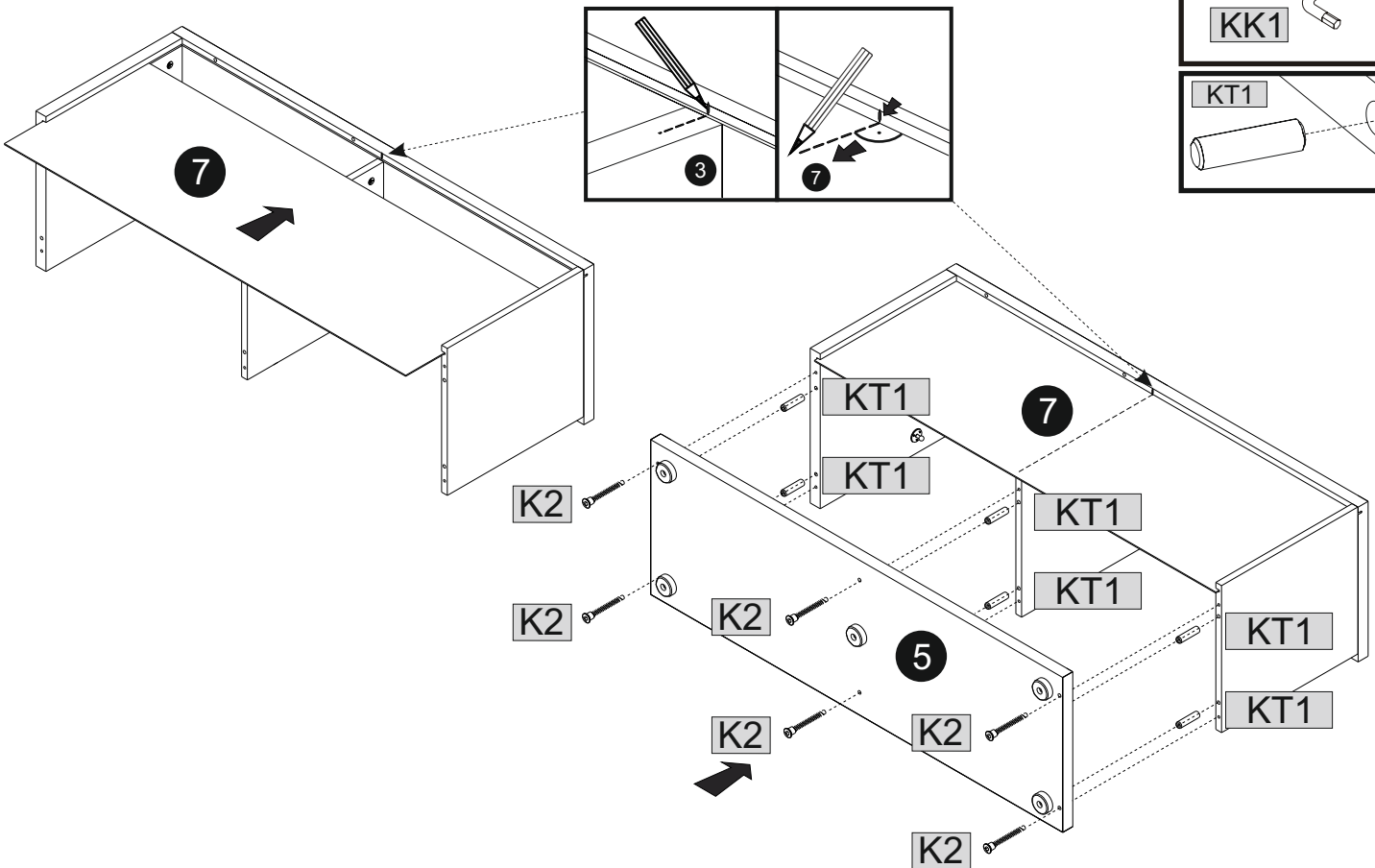
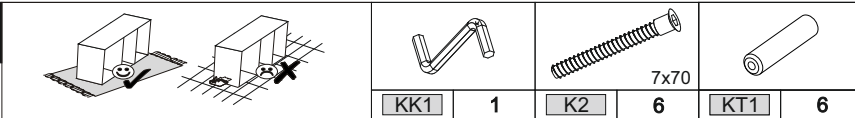

07

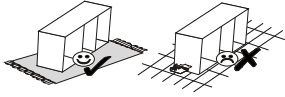

| | | | |
|------|---|----|---|
| 3x16 | | S1 | |
| W1 | 4 | S1 | 6 |

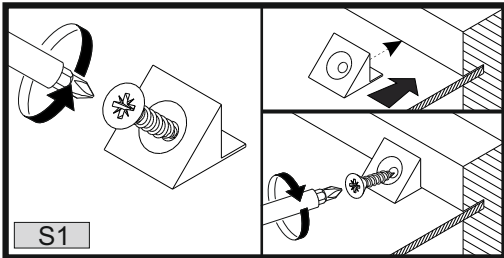
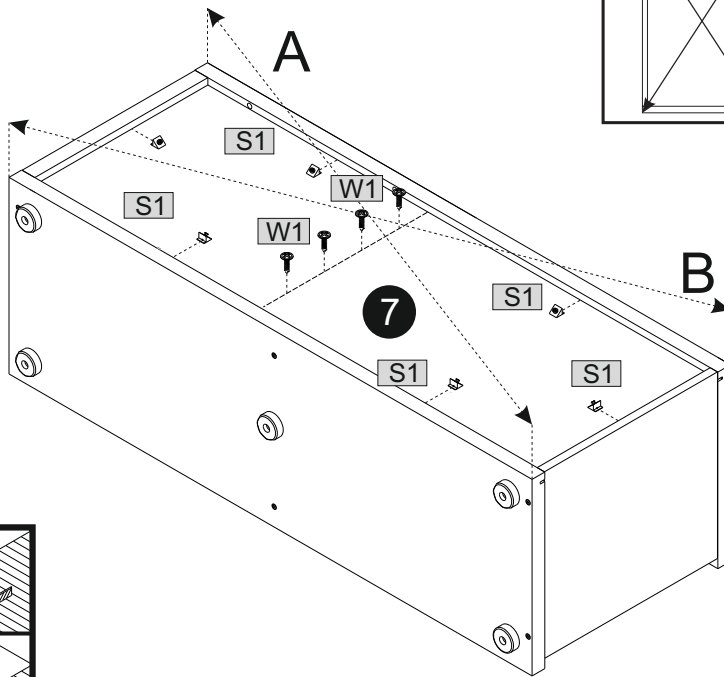
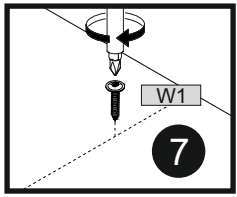
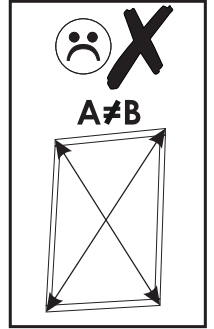
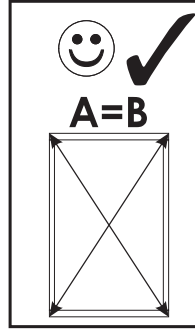

08

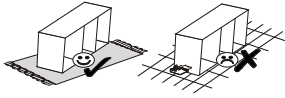

| | | | |
|-----|---|-----|---|
| KK1 | | KT1 | |
| KK1 | 1 | KT1 | 4 |

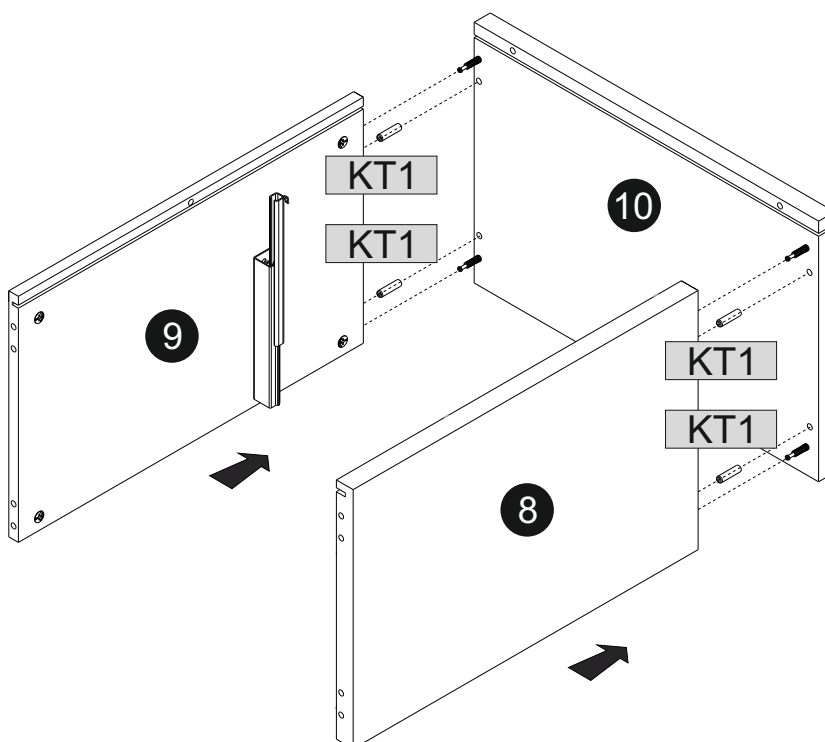
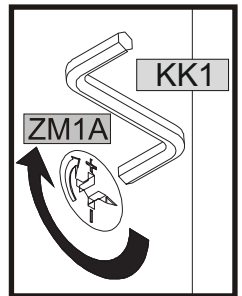
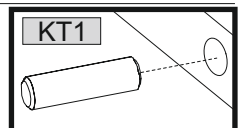

09

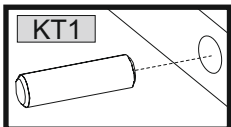
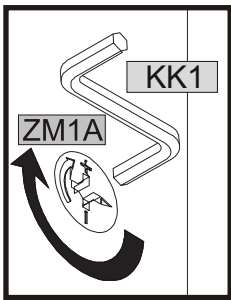
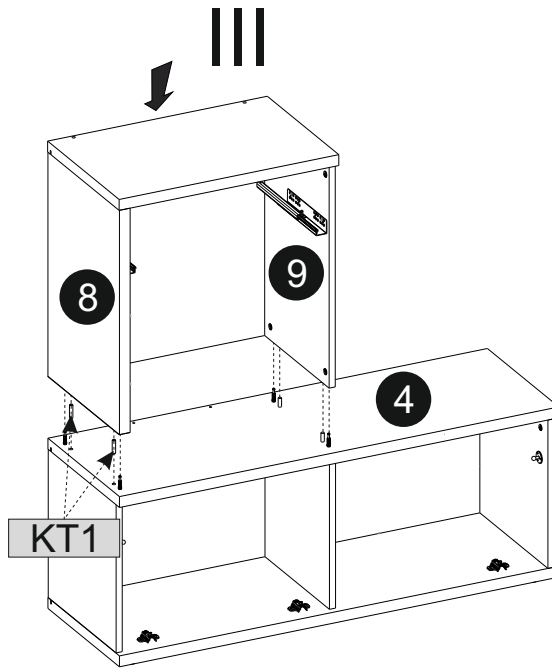
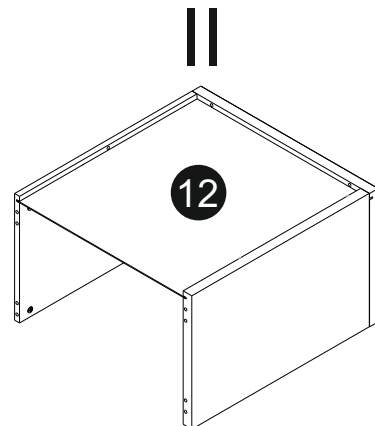
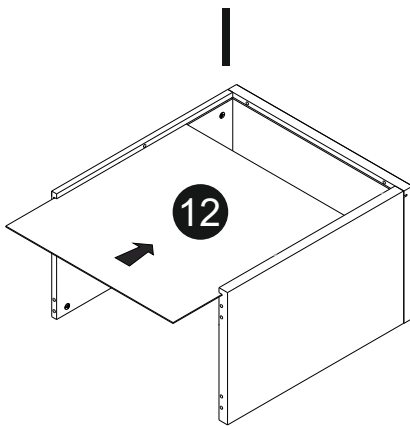
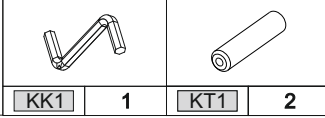
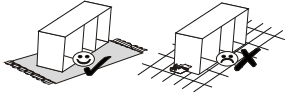

10

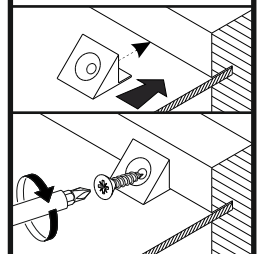
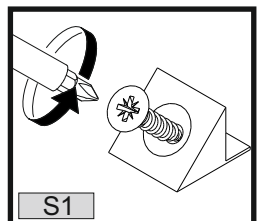
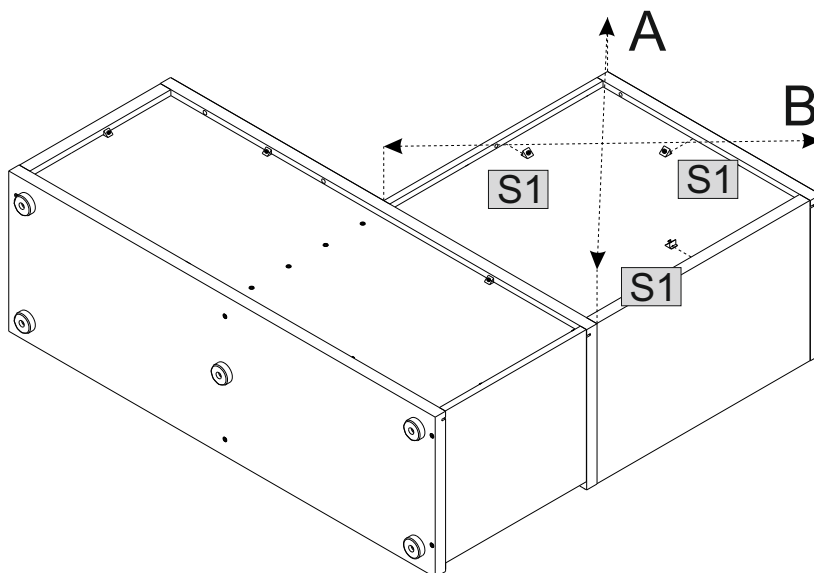
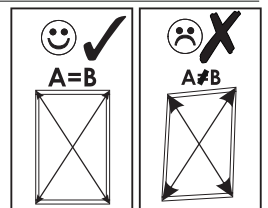
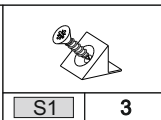
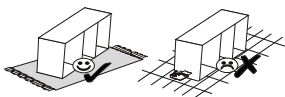

11

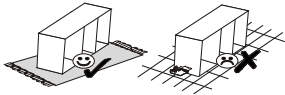

| | | | | | | | | | |
|-----|---|----|---|----|---|-----|---|-----|---|
| KK1 | 1 | K2 | 4 | W9 | 2 | WG3 | 1 | W13 | 2 |
|-----|---|----|---|----|---|-----|---|-----|---|

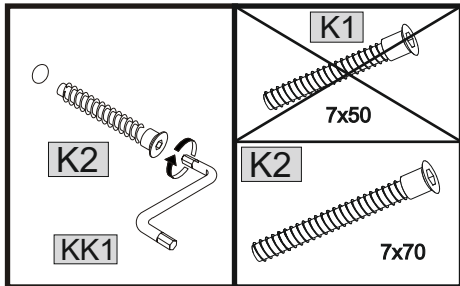
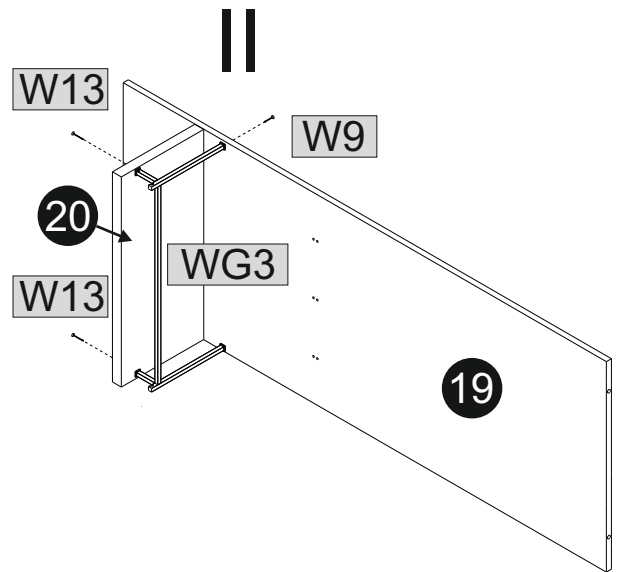
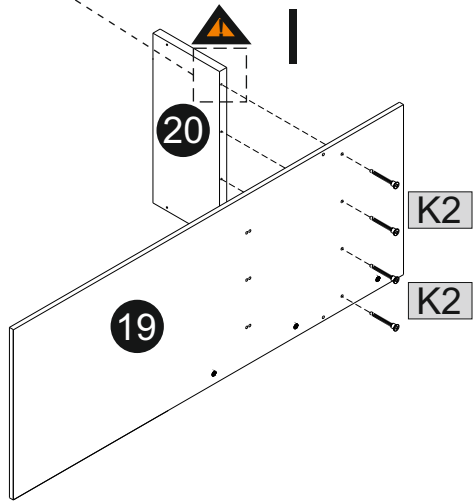
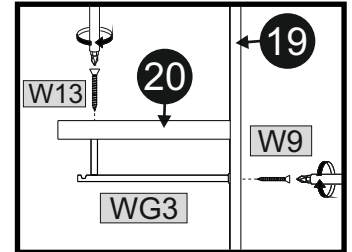
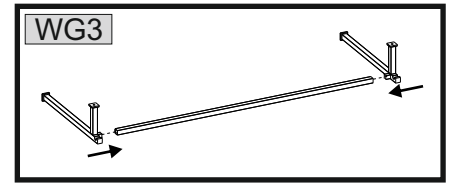
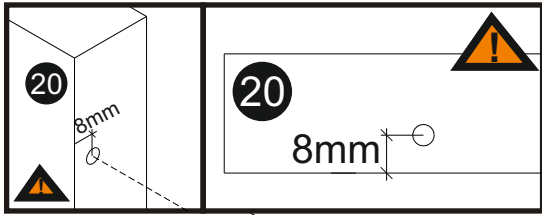

12

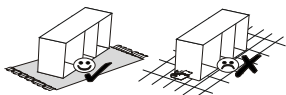

| | | | |
|----|---|-----|---|
| W7 | 6 | WV1 | 3 |
|----|---|-----|---|

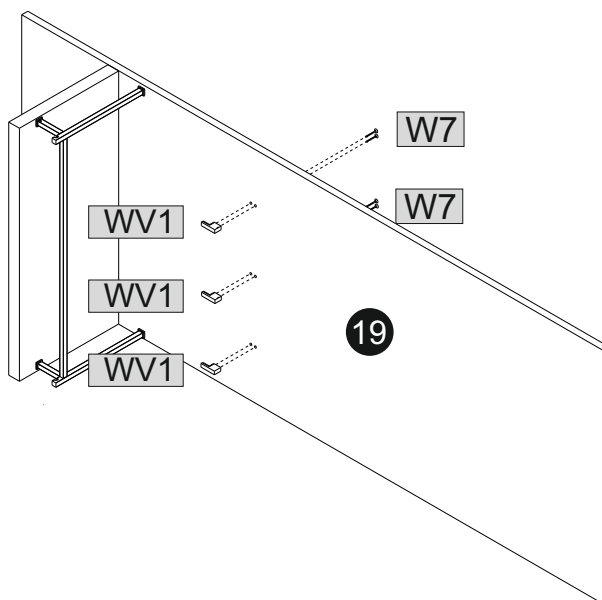
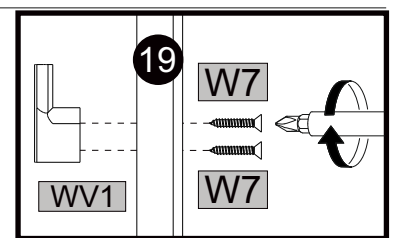

13

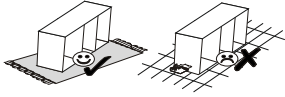

| | | | | | | | | | |
|-----|---|----|---|------|---|----|---|------|---|
| | | | | | | | | | |
| KK1 | 1 | K2 | 2 | 7x70 | 2 | K1 | 1 | 7x50 | 1 |
| | | | | | | | | PP | 2 |

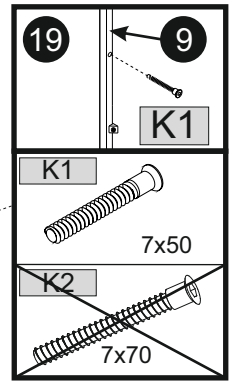
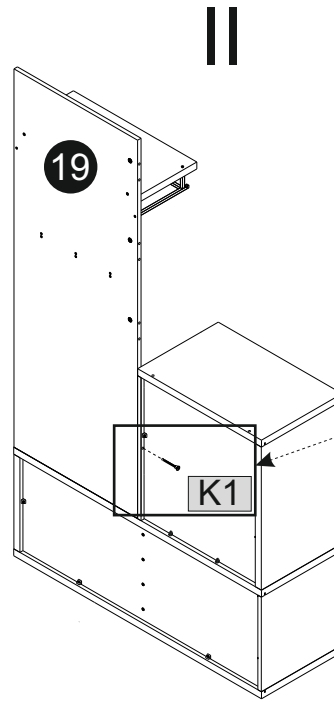
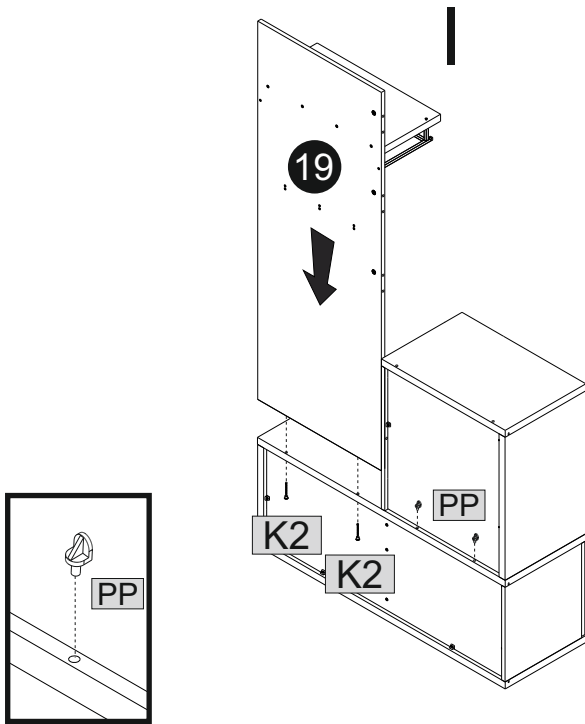
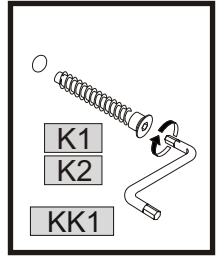

14

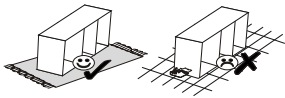

| | | | | | | | | | |
|-----|---|------|---|------|---|-----|---|------|---|
| | | | | | | | | | |
| KK1 | 1 | TPP3 | 3 | 8x60 | 3 | KD2 | 3 | 7x70 | 2 |
| | | | | | | | | | |

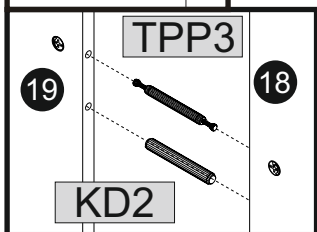
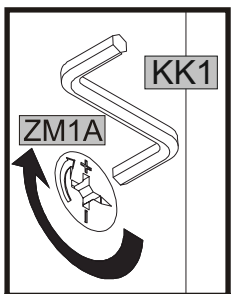
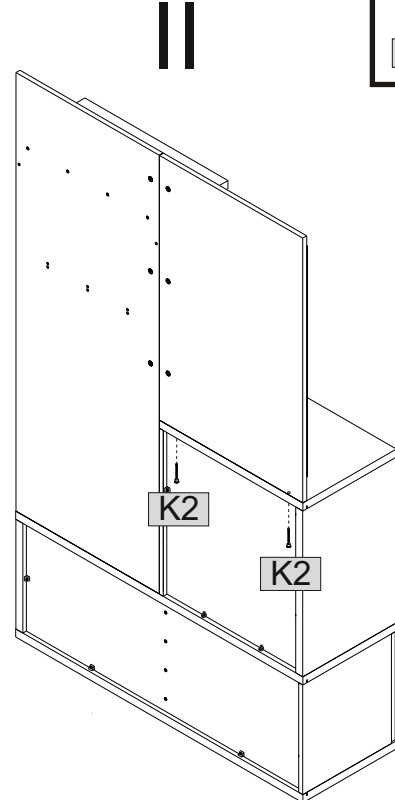
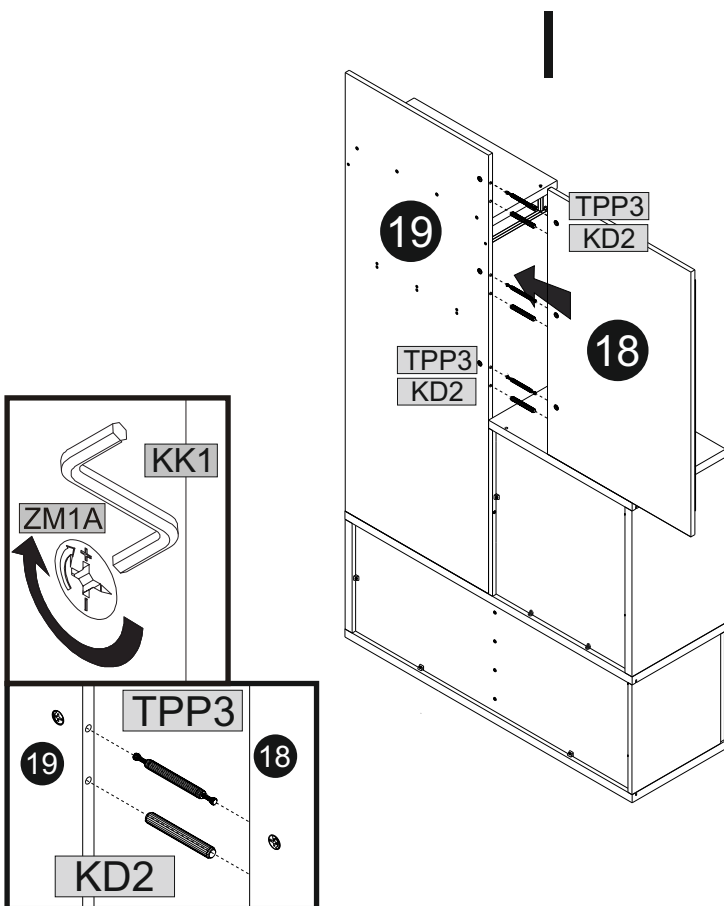
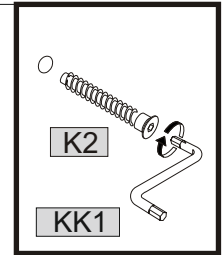

15

| | | | | |
|-------|---|-------|------|------|
| | | | | |
| | | 12x12 | 8x35 | |
| MZM1A | 2 | KT1 | 4 | ZM1B |

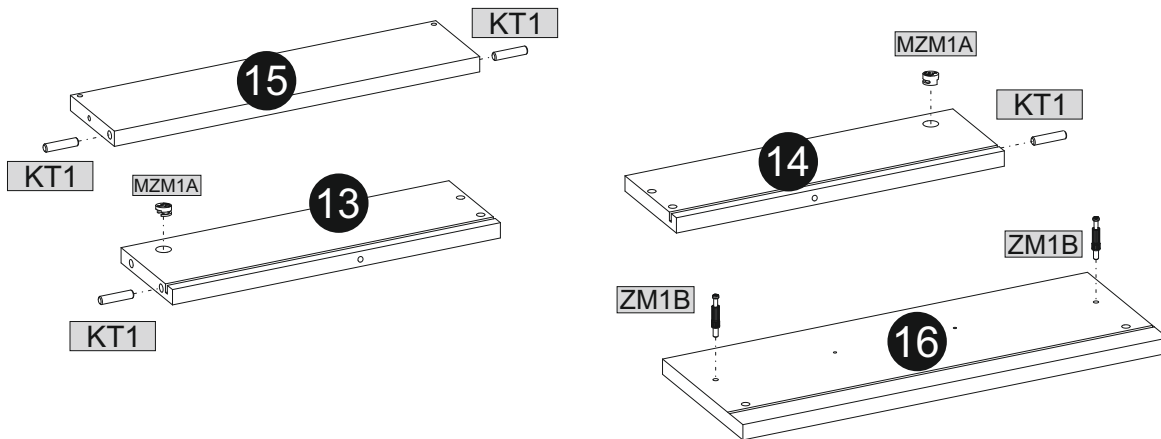
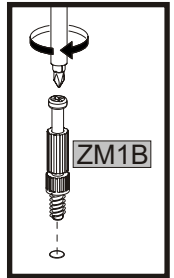
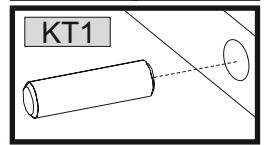
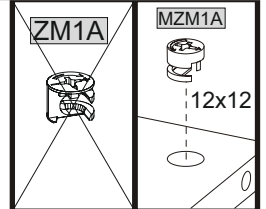

16

| | | | | | |
|-----|---|--------|------|-----|---|
| | | | | | |
| | | 5x42 | 3x16 | | |
| KM1 | 2 | W1 | 4 | KK1 | 1 |
| | | | | | |
| | | 3,5x27 | S1 | 1 | |
| | | WU | 2 | | |

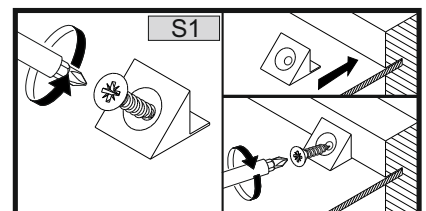
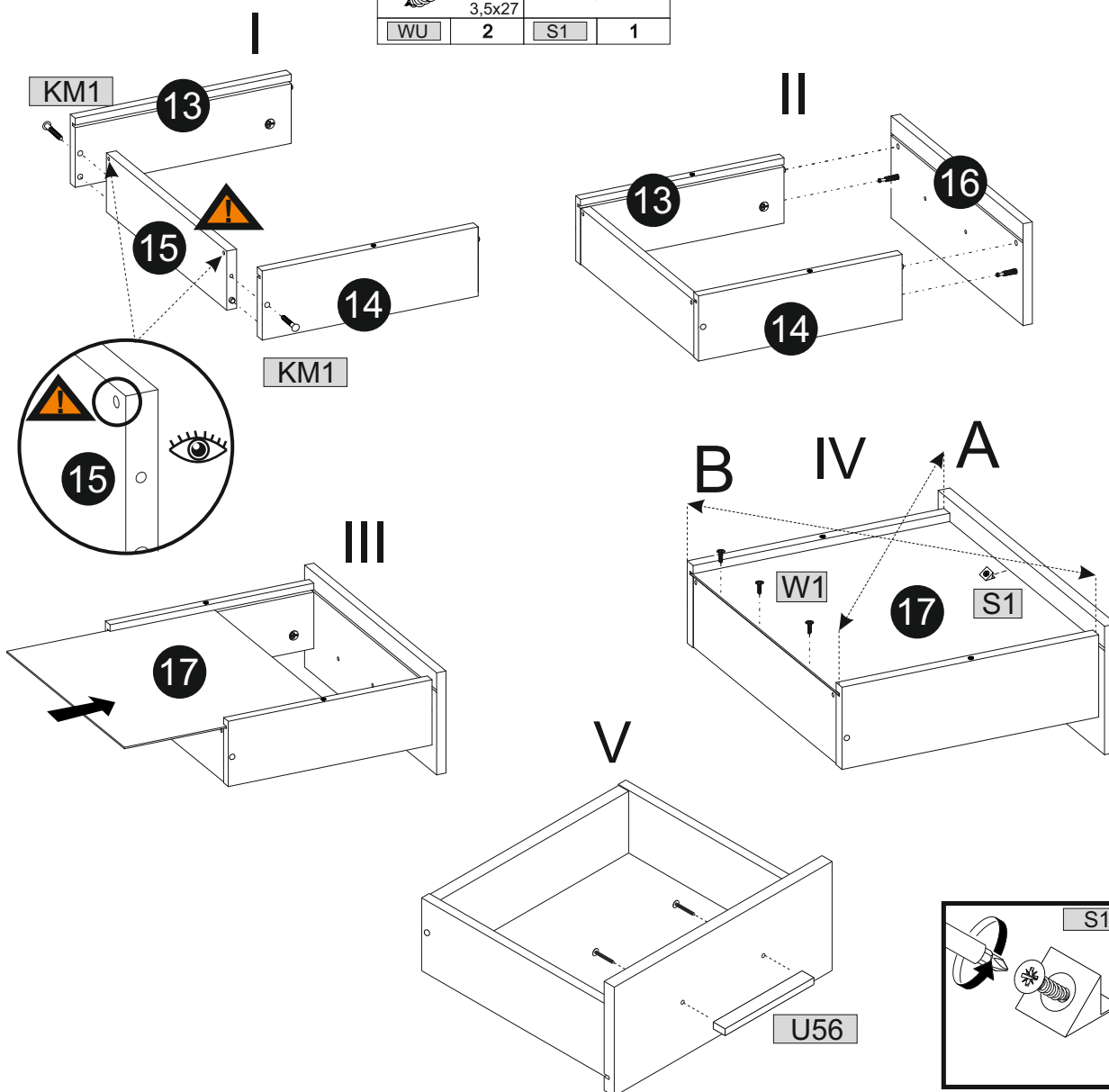
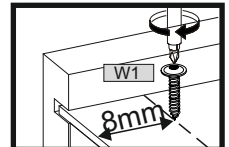
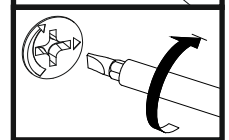
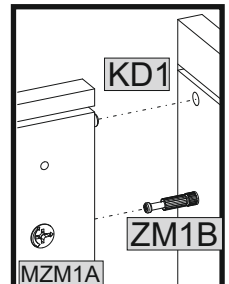
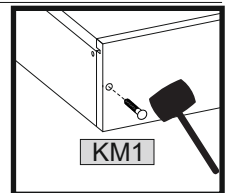

17

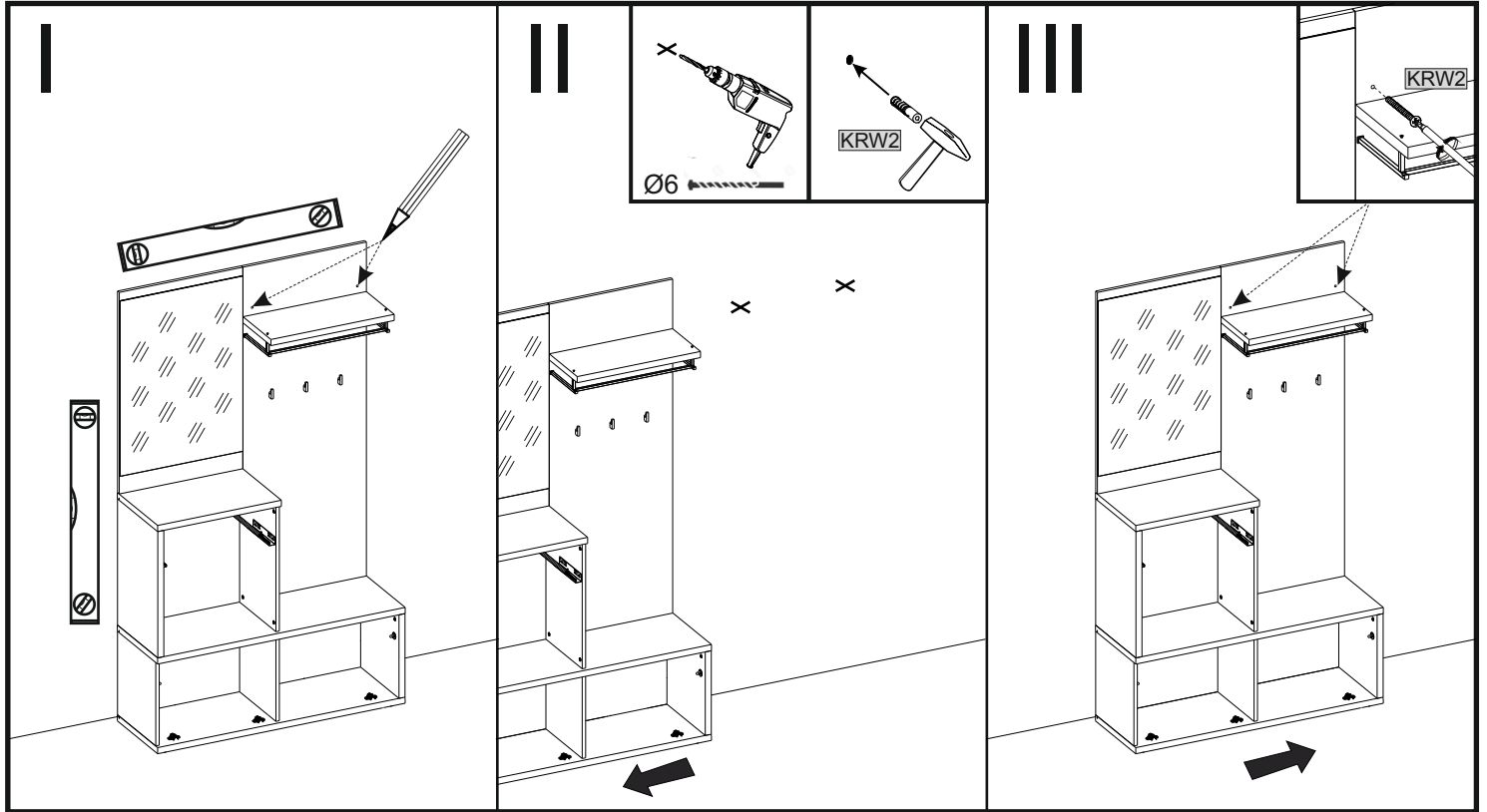
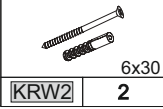
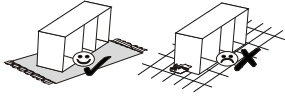

18

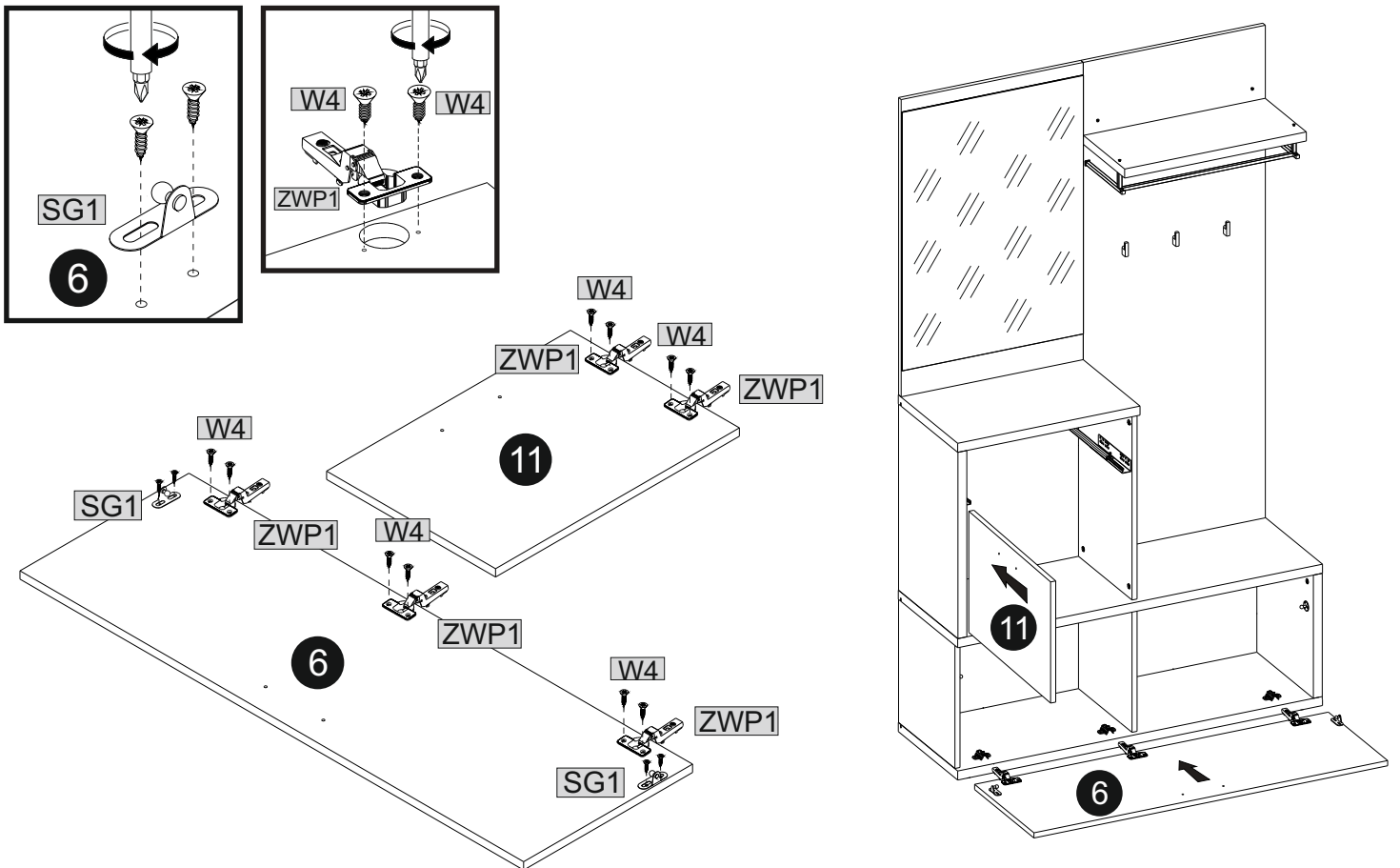
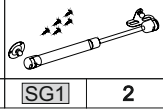
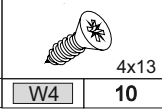
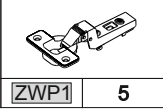
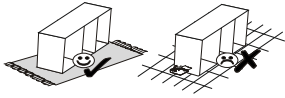

19

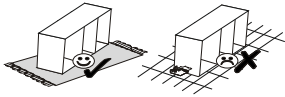

| | | | | | | | | | |
|-----|---|----|---|-----|---|-----|---|-----|---|
| | 2 | | 4 | | 2 | | 8 | | 6 |
| U56 | | WU | | SG1 | | ZM1 | | ZM2 | |

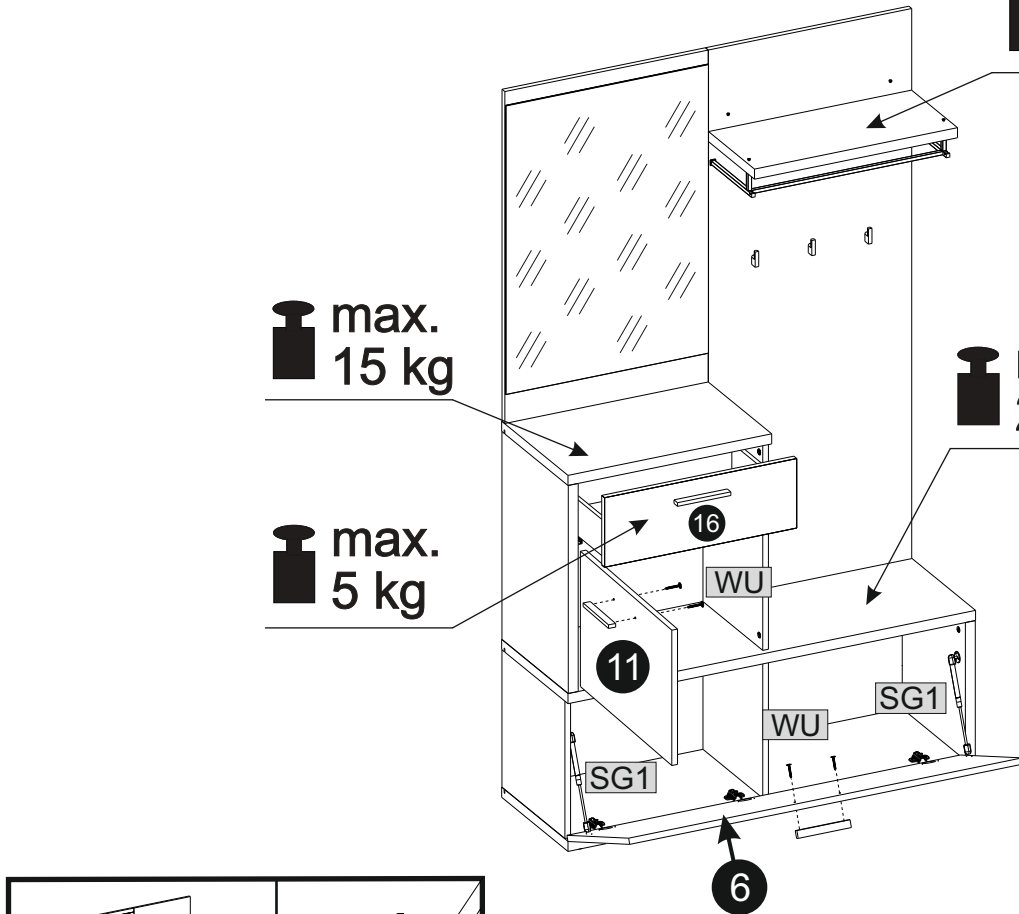
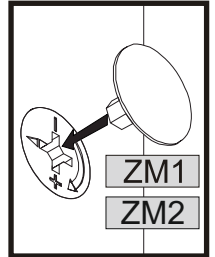
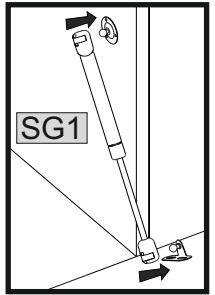
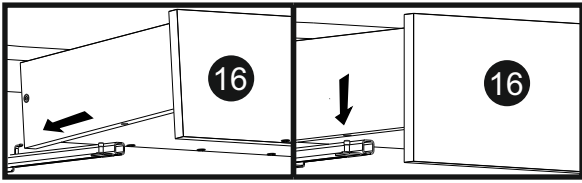

max. 5 kg

max. 15 kg

max. 20 kg

max. 5 kg

