

Nature One 12 18 FF 01

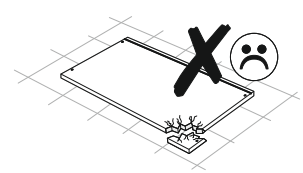

Nature One 12 18 FF 01

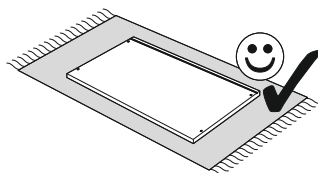
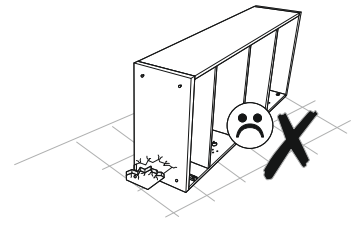
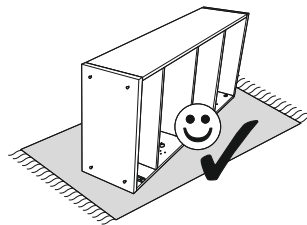
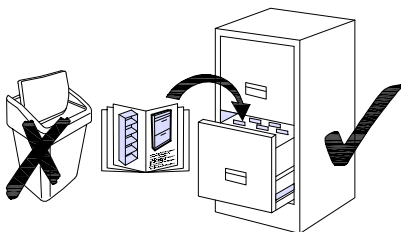
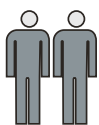
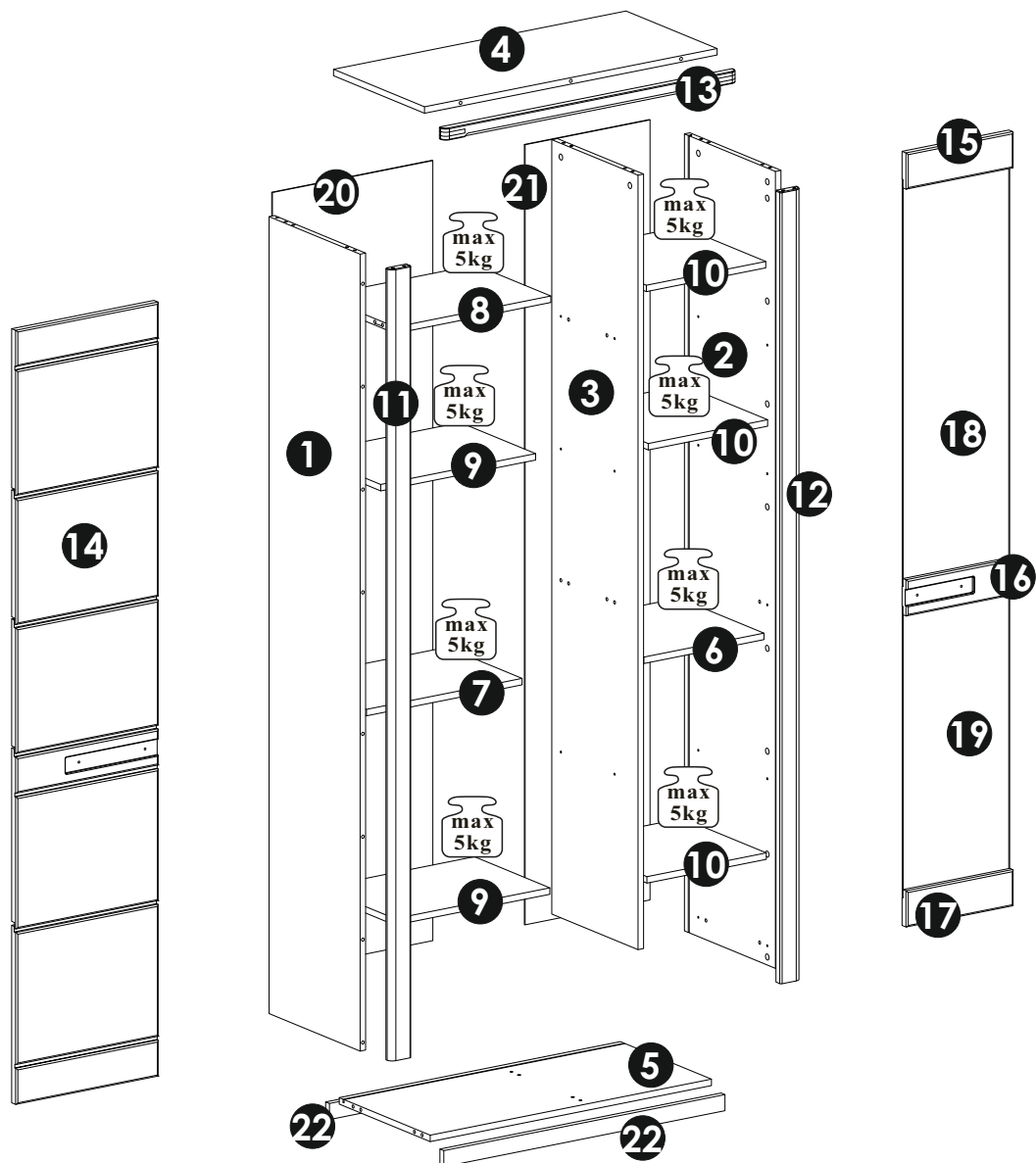

135 min

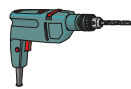
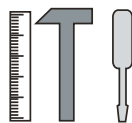

NO	Dim.(mm)			Col.-No	Qty
1	1983	380	16	1/3	1
2	1983	380	16	1/3	1
3	1927	360	16	1/3	1
4	849	380	16	2/3	1
5	614	342	16	2/3	1
6	348.5	355	16	2/3	1
7	451.5	315	16	2/3	1
8	451.5	315	16	2/3	1
9	449.5	315	16	2/3	2
10	346.5	350	16	2/3	3
11	1970	60	20	3/3	1
12	1970	60	20	3/3	1
13	851	30	20	3/3	1





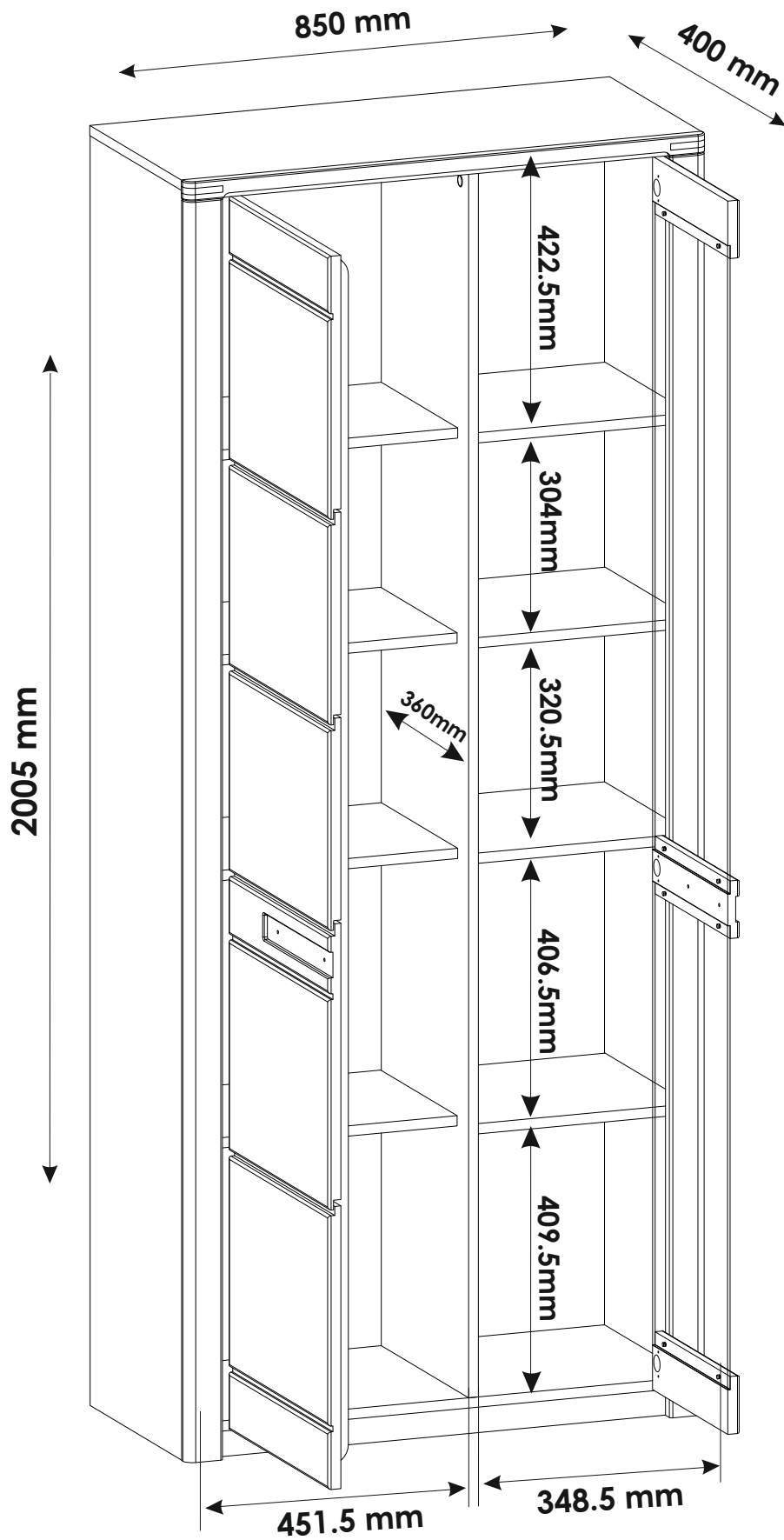

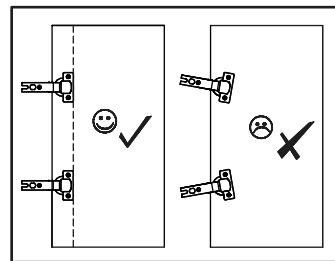
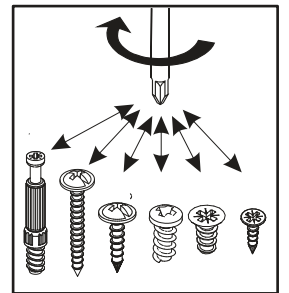
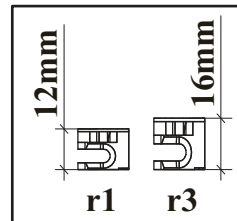
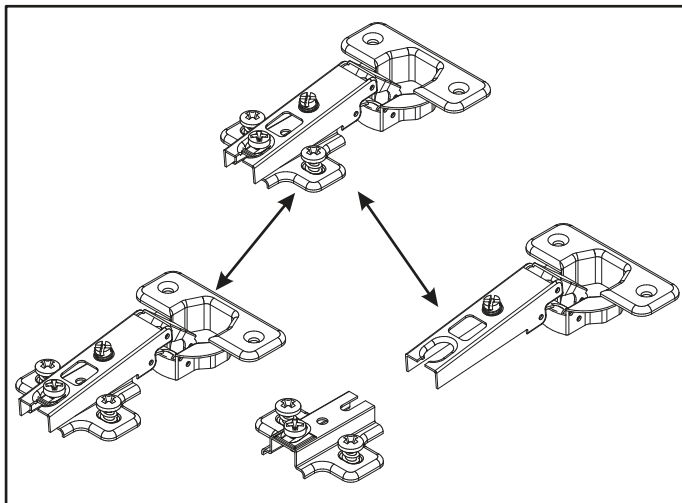
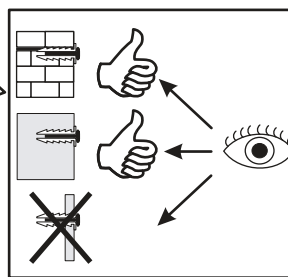
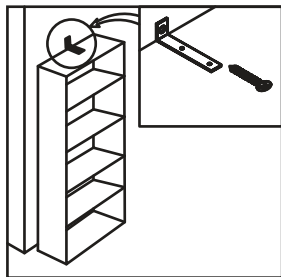
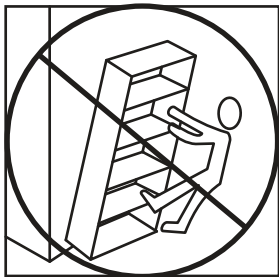
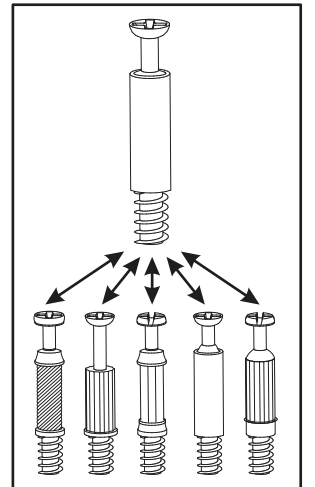
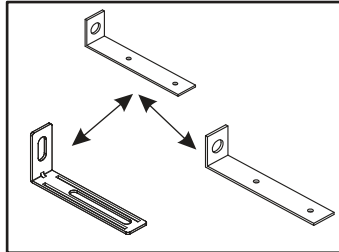
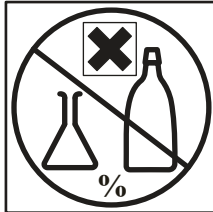
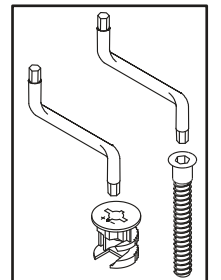
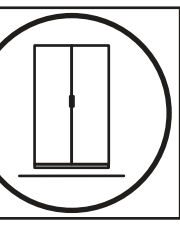
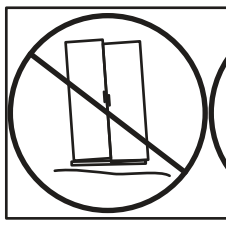
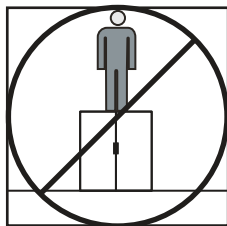
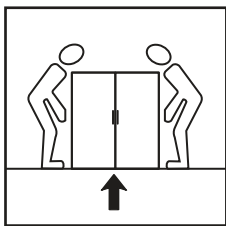
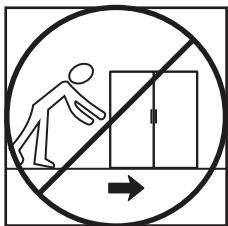
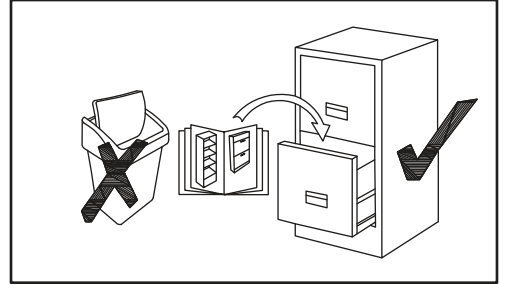
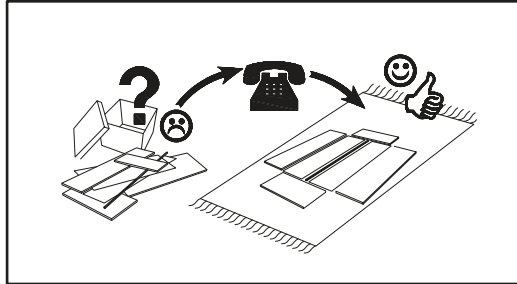
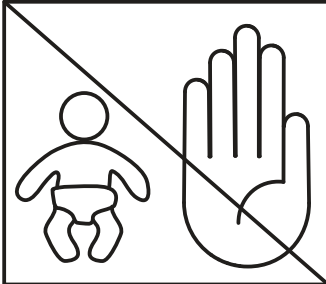
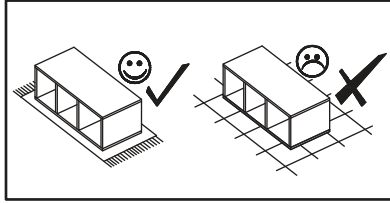
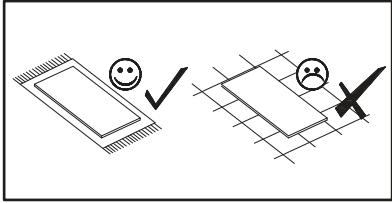
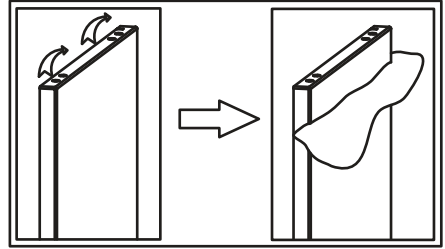



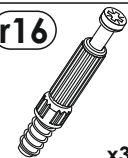

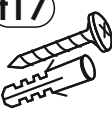
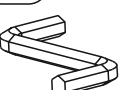
NO	Dim.(mm)			Col.-No	Qty
14	1926	413	20	3/3	1
15	310	90	20	3/3	1
16	310	90	20	3/3	1
17	310	90	20	3/3	1
18	309	1012	4	3/3	1
19	309	724	4	3/3	1
20	1941	465.5	3	1/3	1
21	1941	362.5	3	1/3	1
22	816	40	16	2/3	2
A				2/3	1

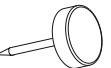
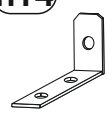
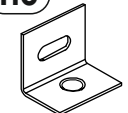
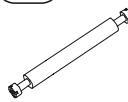
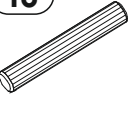
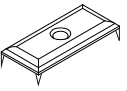
Nature One 12 18 FF 01







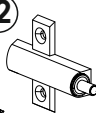

A1

<p>f1</p>  <p>φ8x30 mm x24</p>	<p>r16</p>  <p>x37</p>	<p>r1</p>  <p>x41</p>	<p>e1</p>  <p>φ6.5x50 mm x2</p>	<p>f17</p>  <p>φ8x50 mm x1</p>	<p>z1</p>  <p>x1</p>	<p>s2</p>  <p>x41</p>
<p>k1</p>  <p>x6</p>	<p>n14</p>  <p>x1</p>	<p>n6</p>  <p>x8</p>	<p>r11</p>  <p>x2</p>	<p>f6</p>  <p>φ8x50 mm x2</p>	<p>l9</p>  <p>x7</p>	<p>d1</p>  <p>φ5x17 mm x20</p>
<p>o21</p>  <p>x4</p>	<p>l2</p>  <p>x14</p>	<p>o27</p>  <p>x8</p>	<p>e2</p>  <p>φ6.3x13 mm x14</p>	<p>p4</p>  <p>φ3.5x16 mm x23</p>		
<p>p1</p>  <p>φ3.5x13 mm x32</p>	<p>j2</p>  <p>M4x20 mm x4</p>	<p>n22</p>  <p>x3</p>				

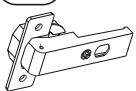

A2

<p>c28</p>  <p>192 mm x1</p>	<p>c27</p>  <p>128 mm x1</p>
---	---

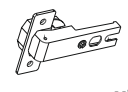
A3

<p>b6</p>  <p>x4</p>	<p>a6</p>  <p>φ35 mm x4</p>
<p>b8</p>  <p>x3</p>	<p>a8</p>  <p>φ26 mm x3</p>



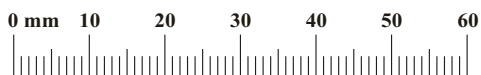

A4

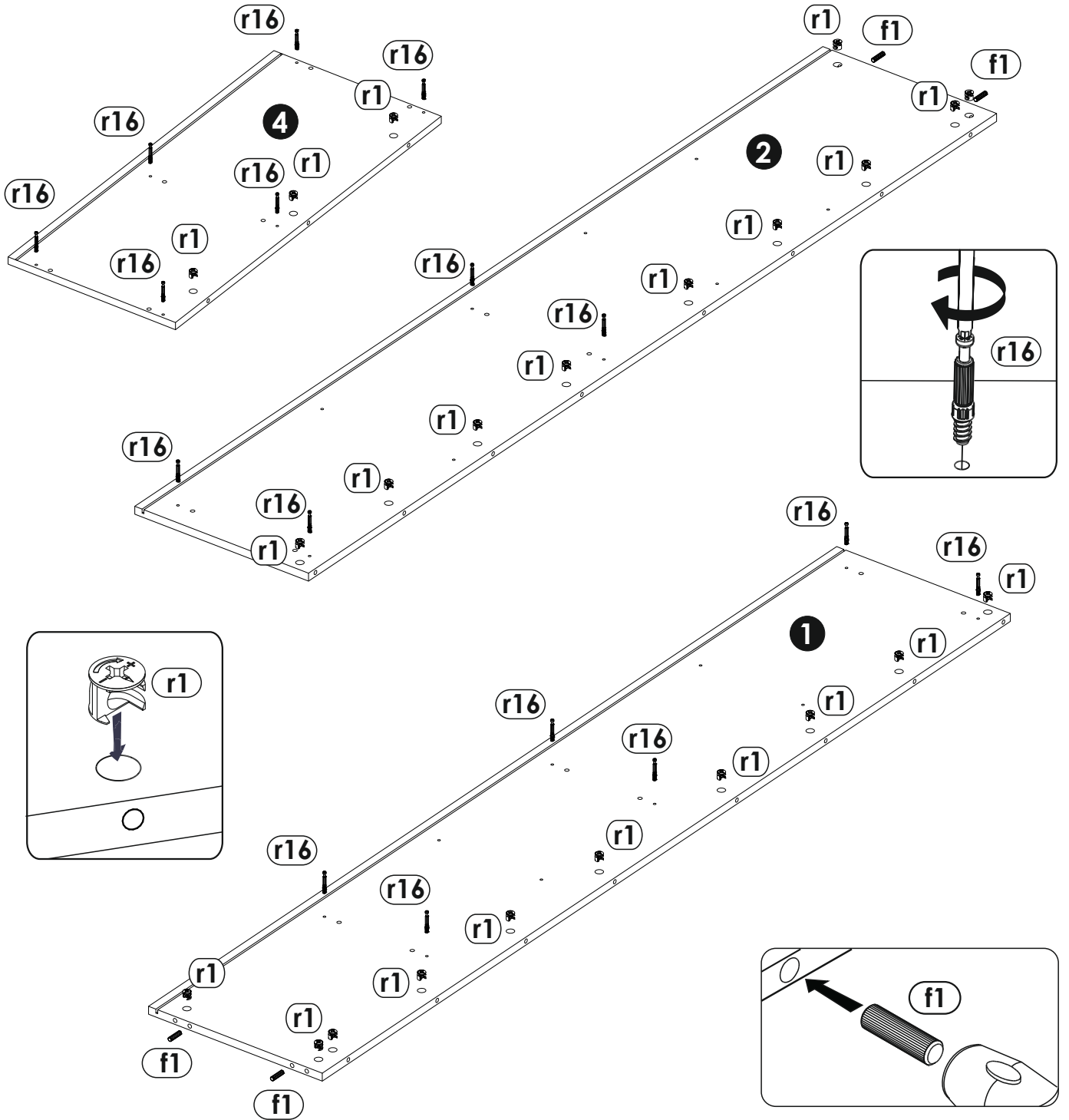
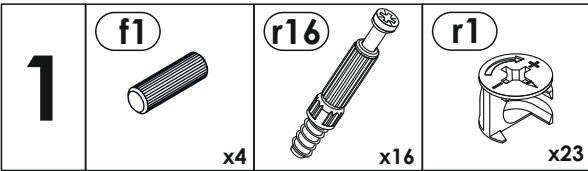
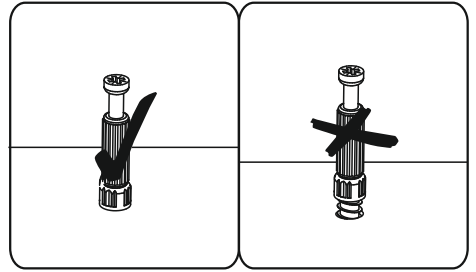
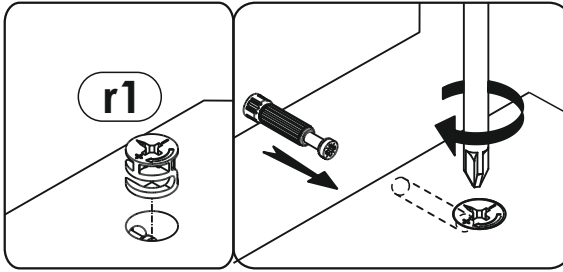
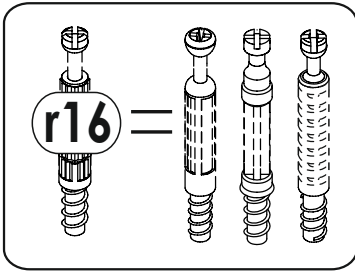
<p>Z3</p>  <p>x3</p>	<p>Y10</p>  <p>x1</p>
--	---

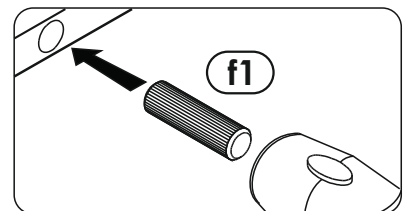
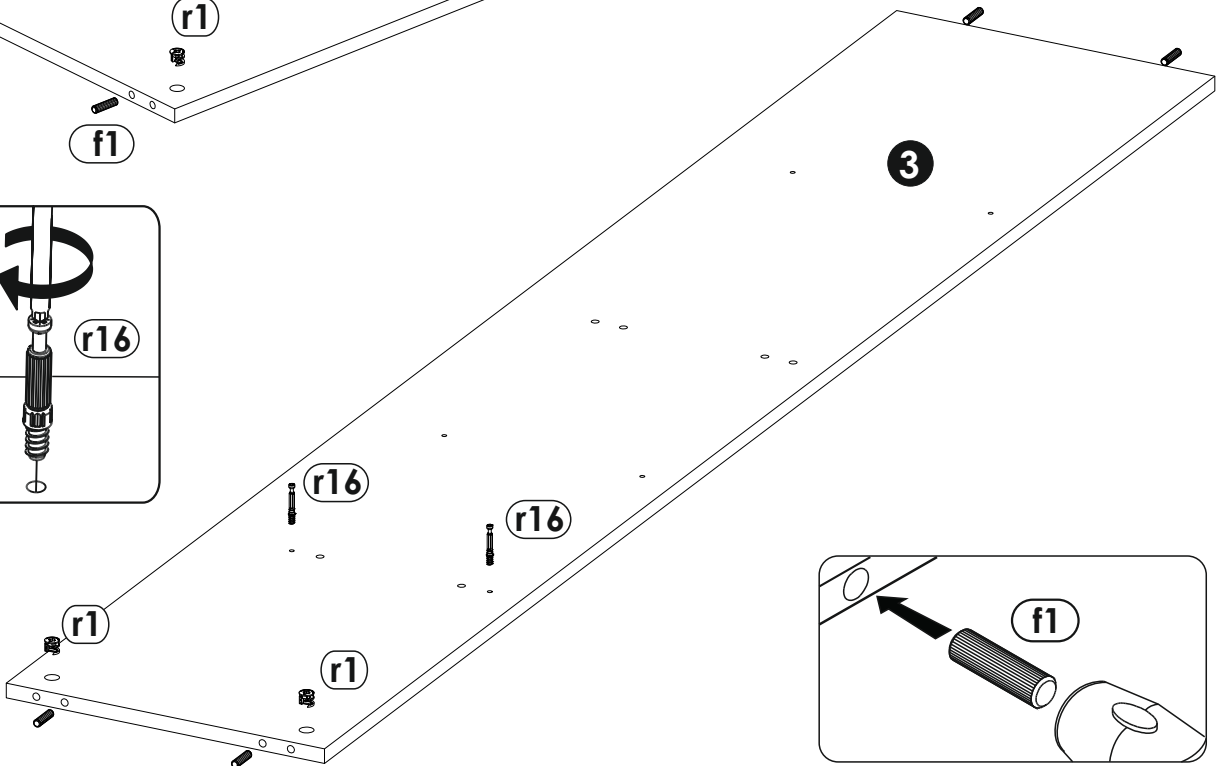
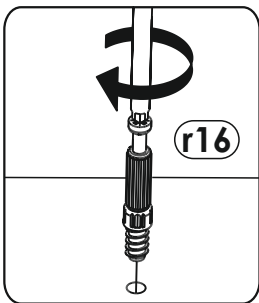
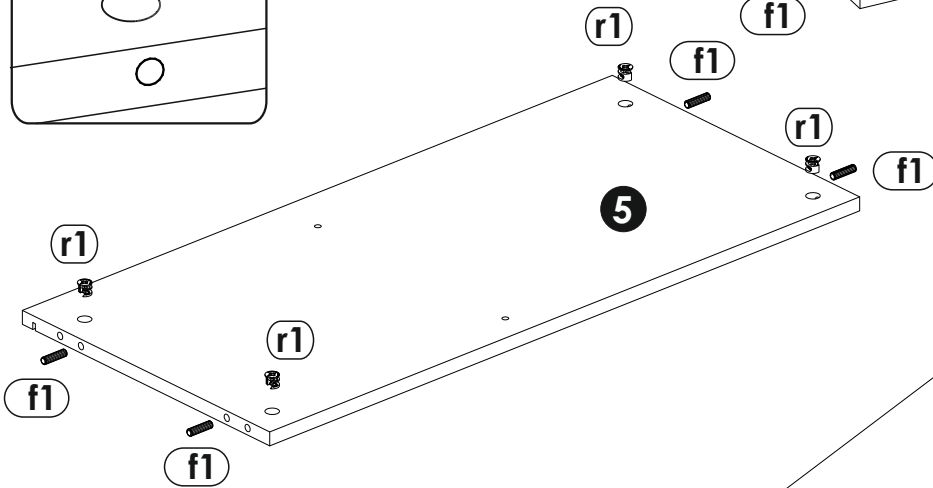
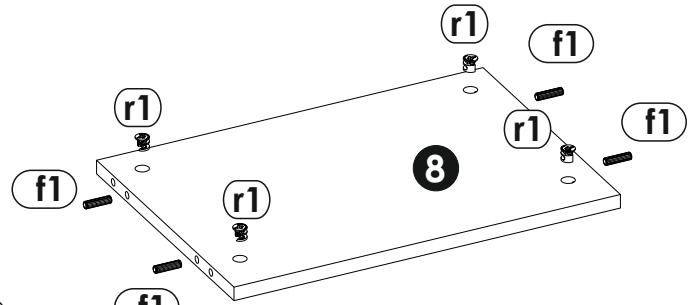
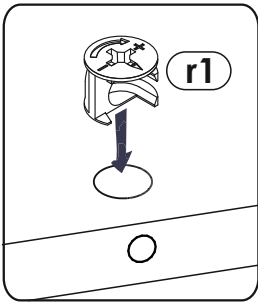
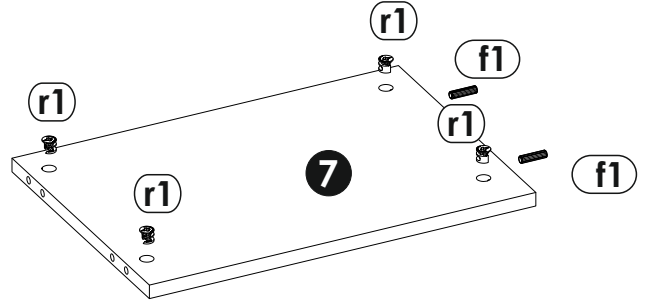
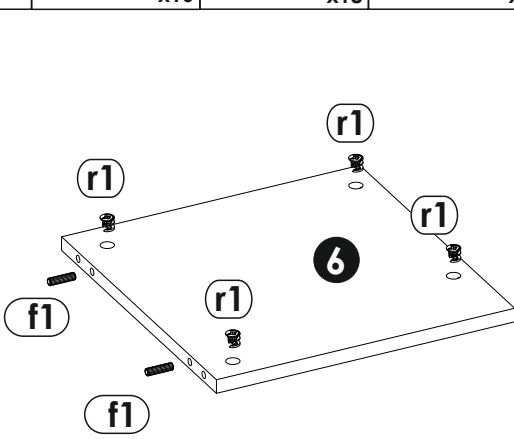
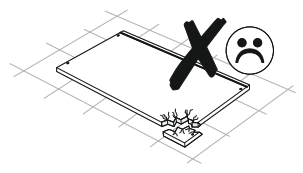
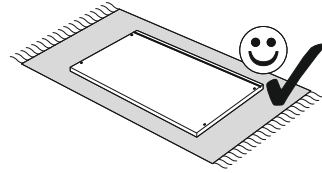
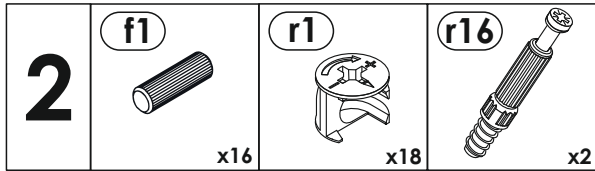



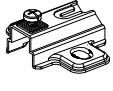
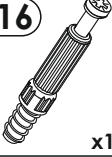

3	e2	b8	b6	r16	f1
	 φ6.3x13 mm x14	 x3	 x4	 x19	 x4

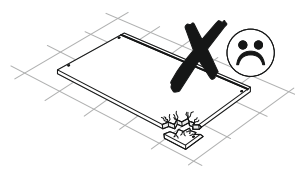
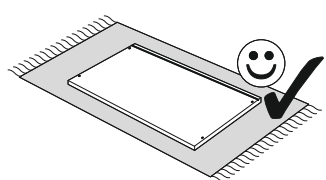
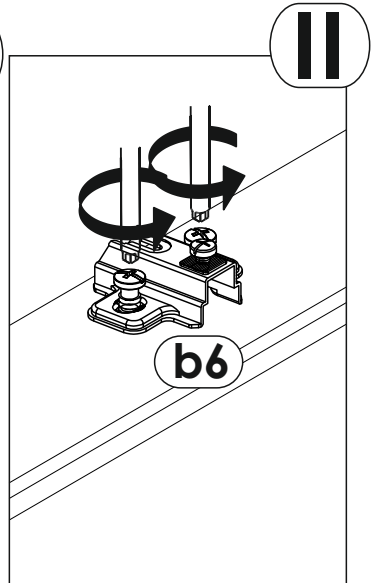
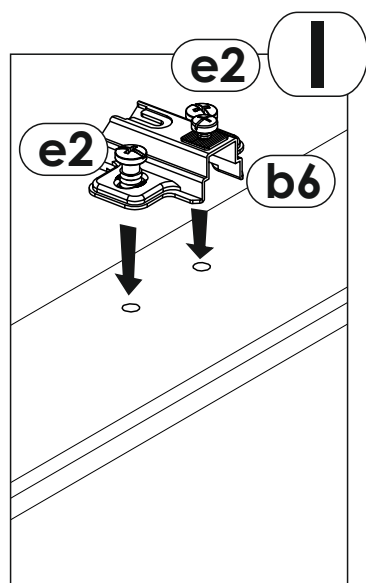
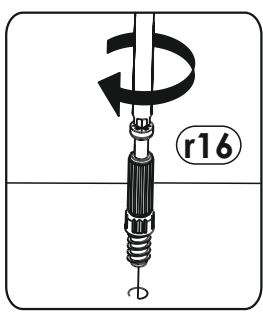
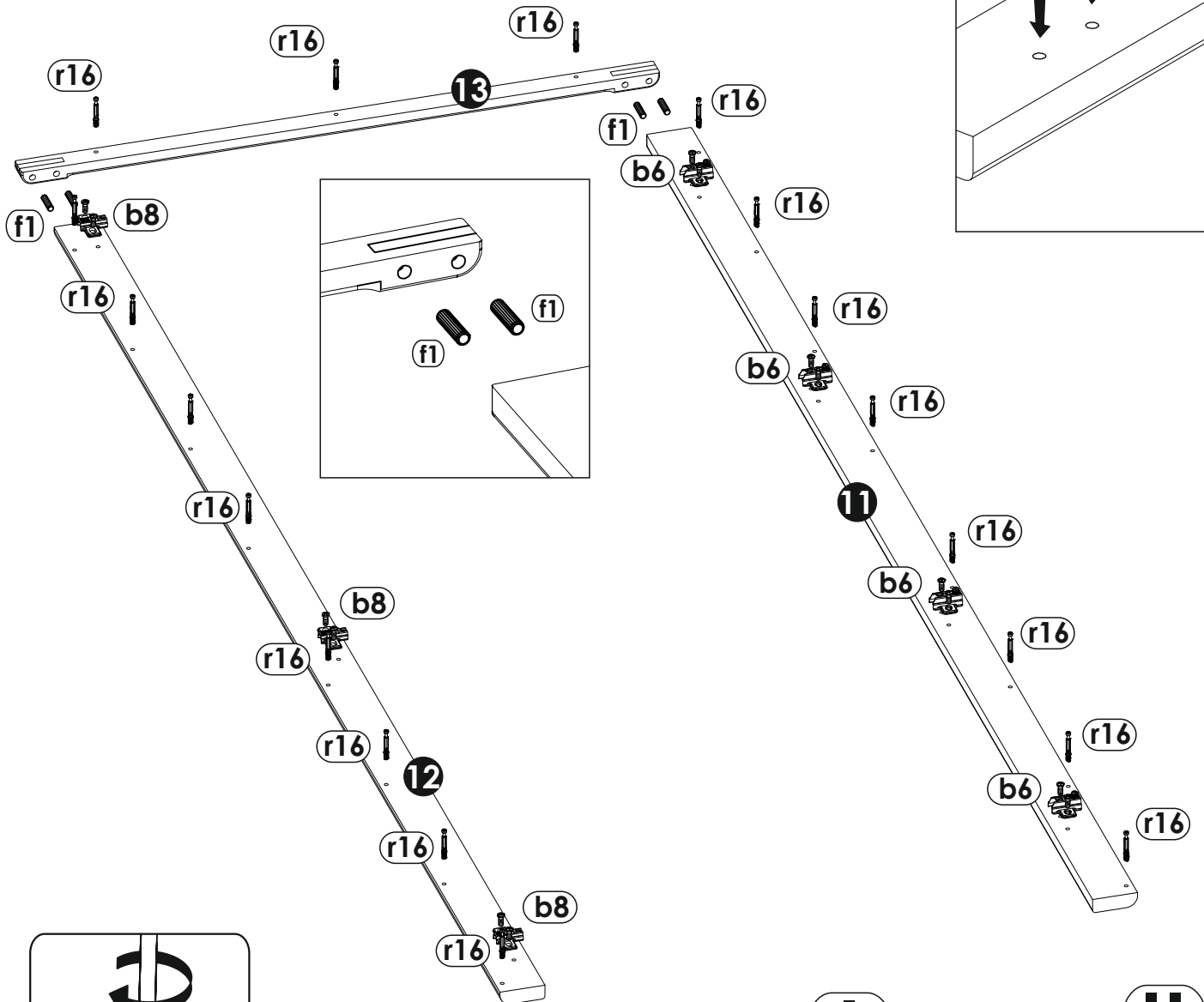
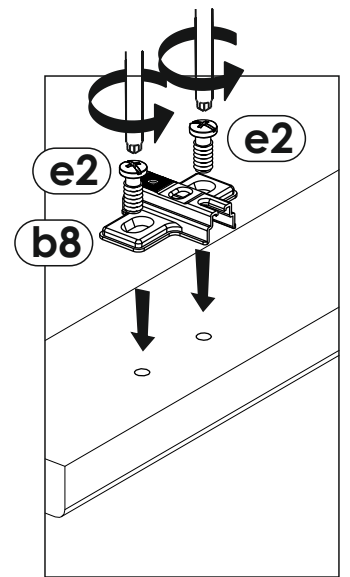

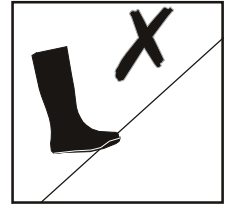

4	a8 x3	p1 φ3.5x13 mm x12	a6 x3	p3 φ3.5x16 mm x8	o27 x8
----------	---------------------	------------------------------------	---------------------	-----------------------------------	----------------------

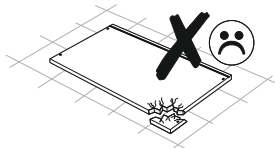
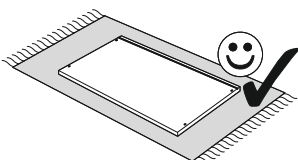
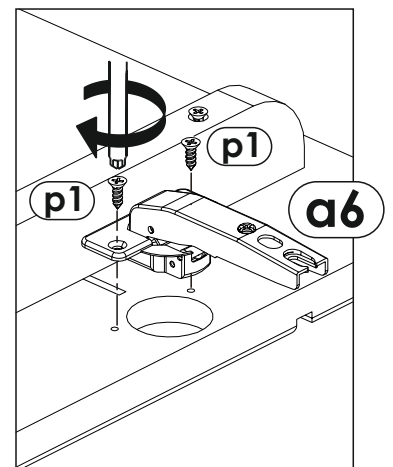
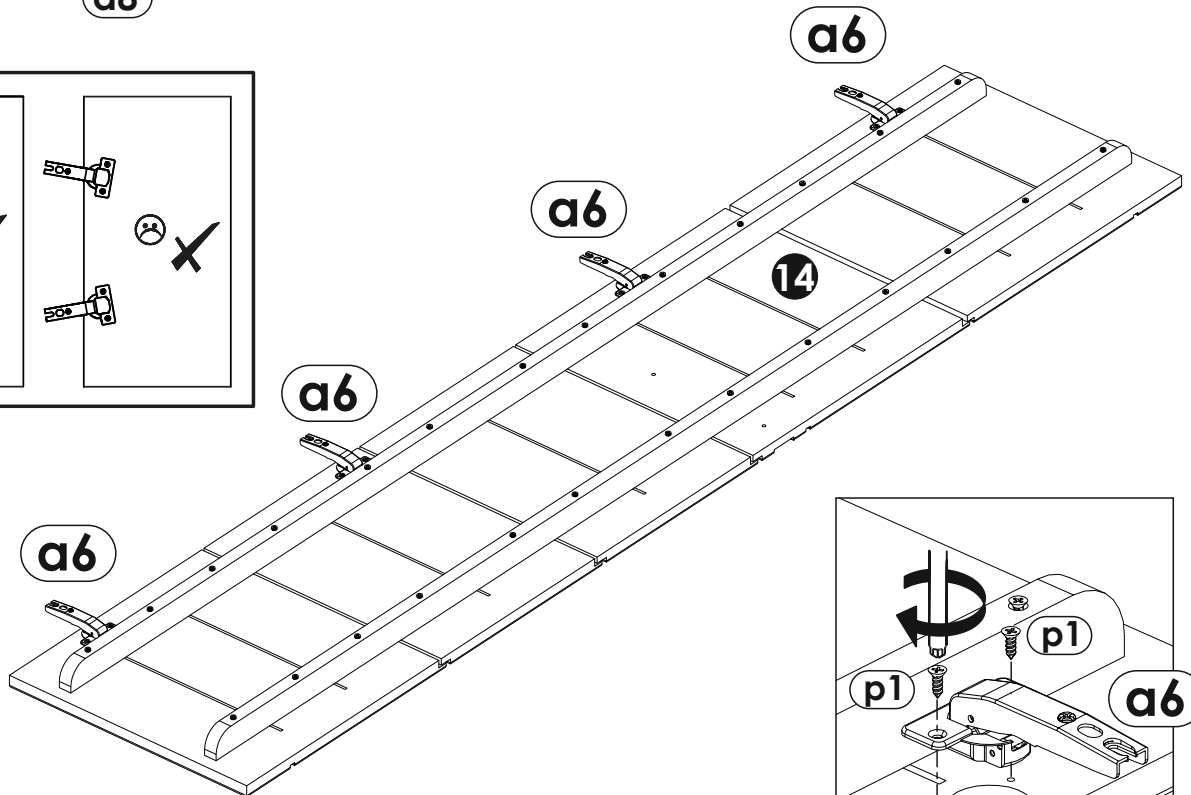
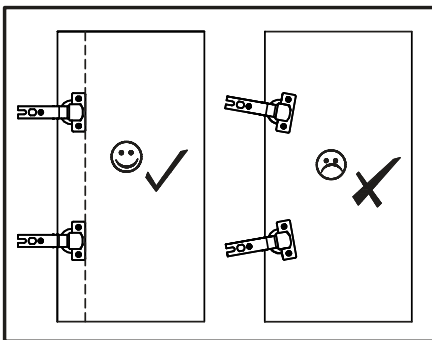
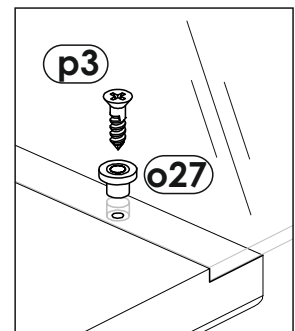
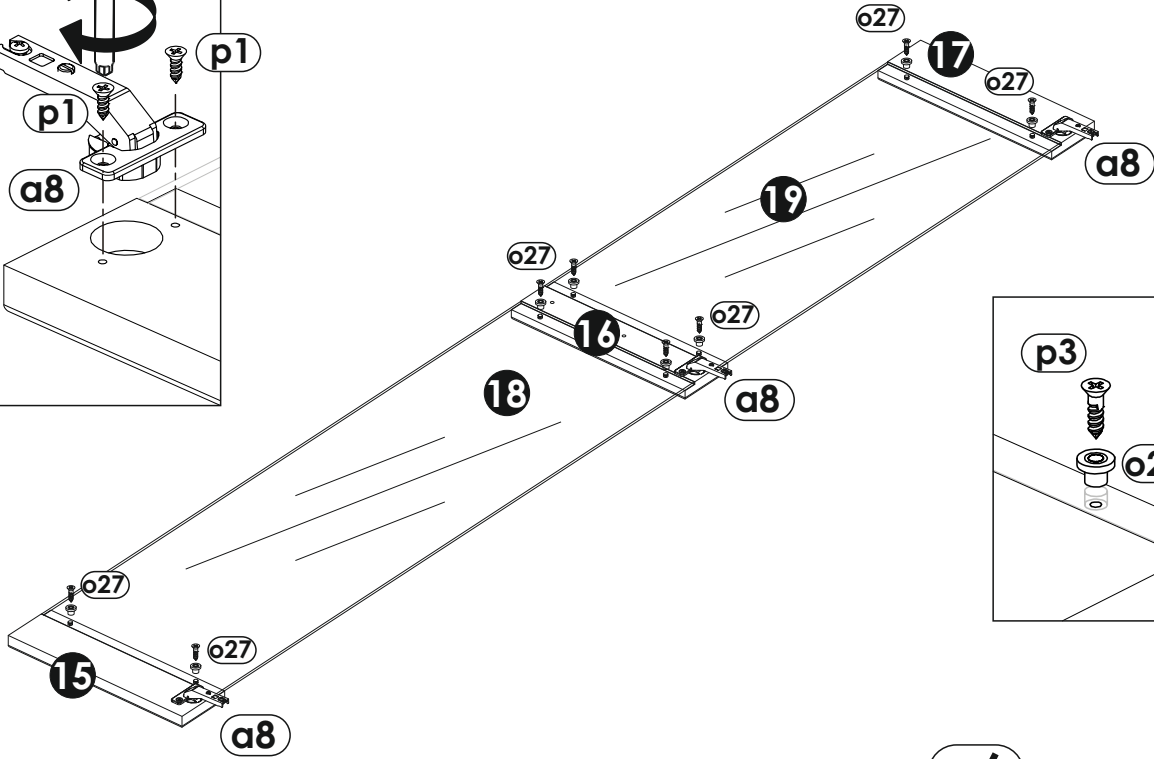
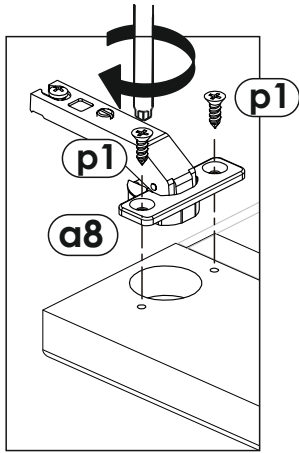

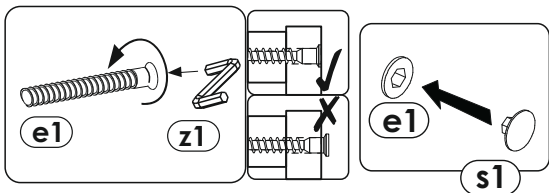
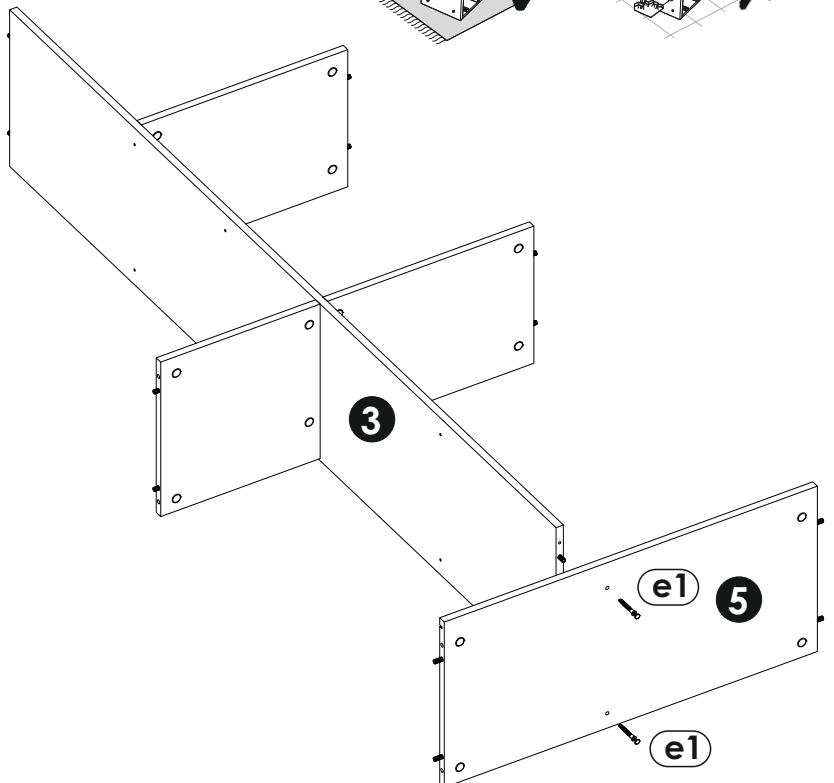
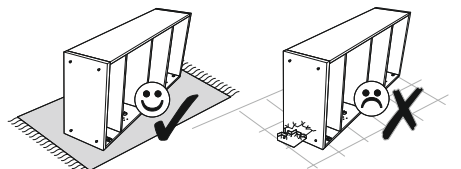
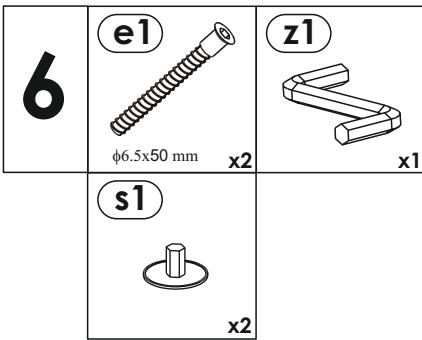
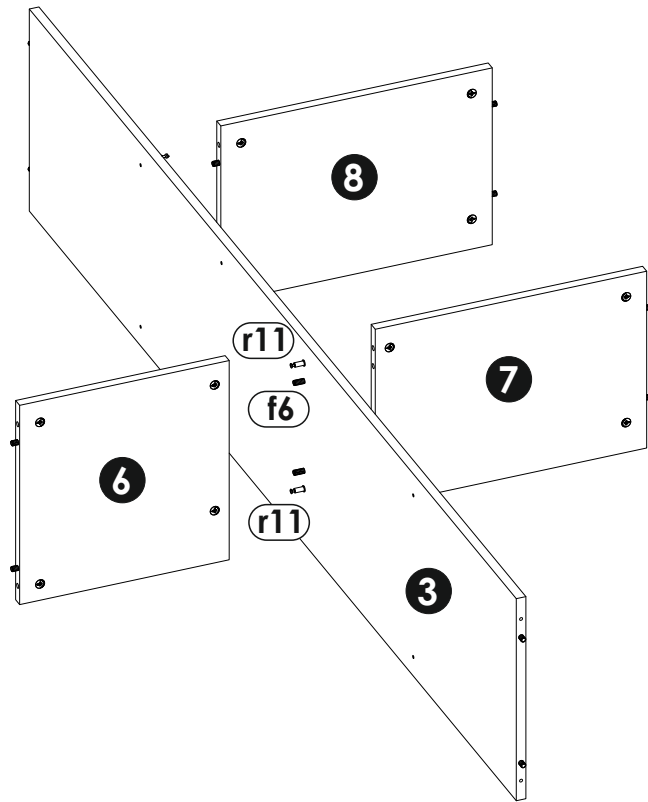
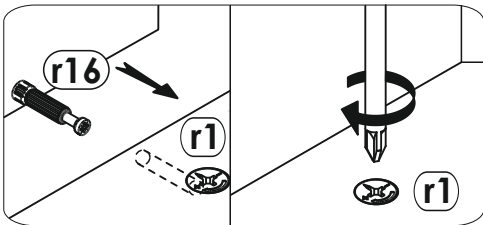
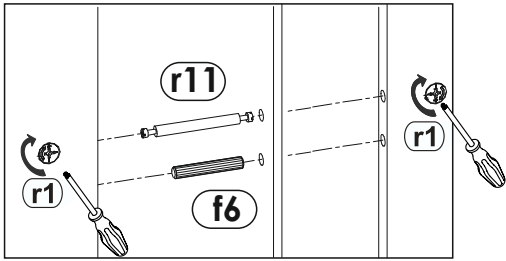
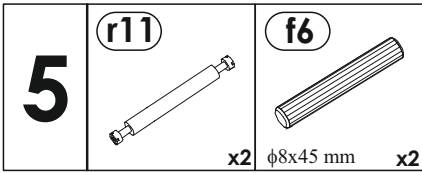
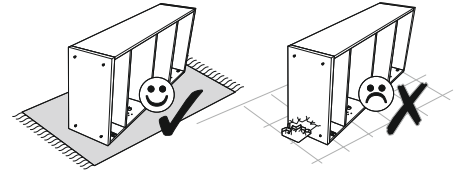

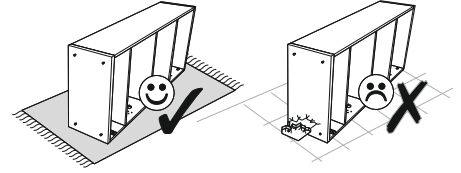

7

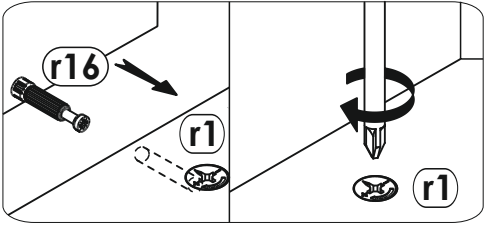
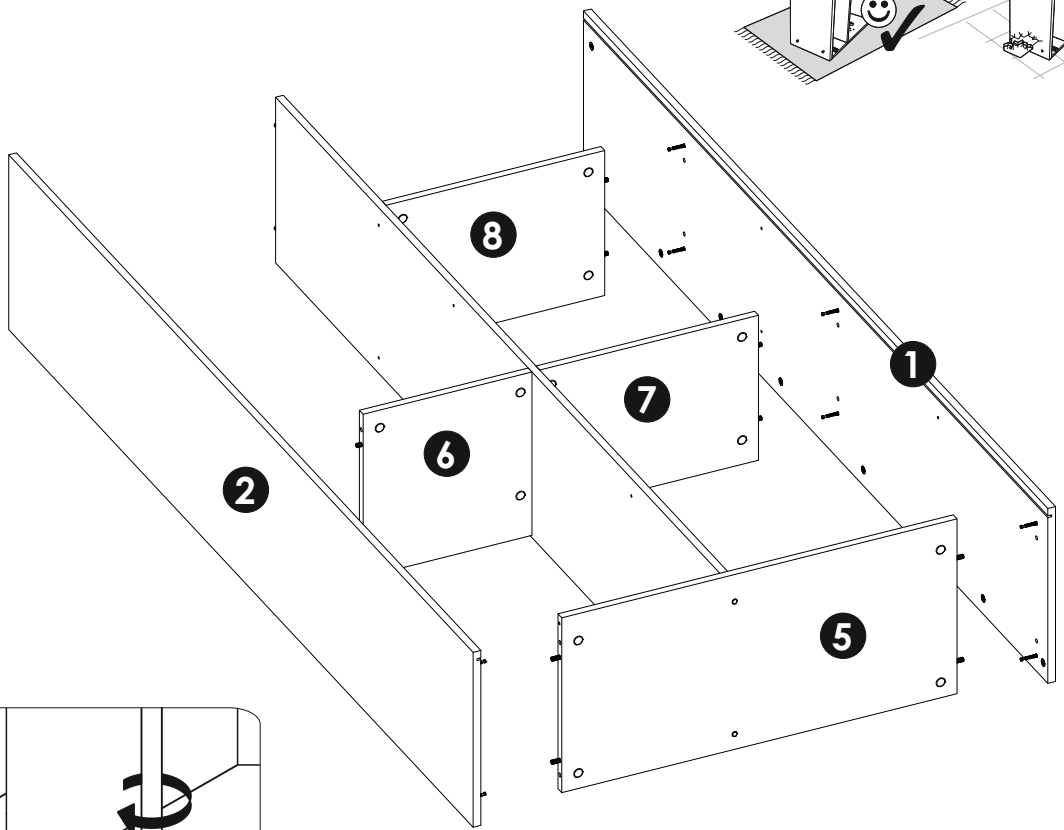

8

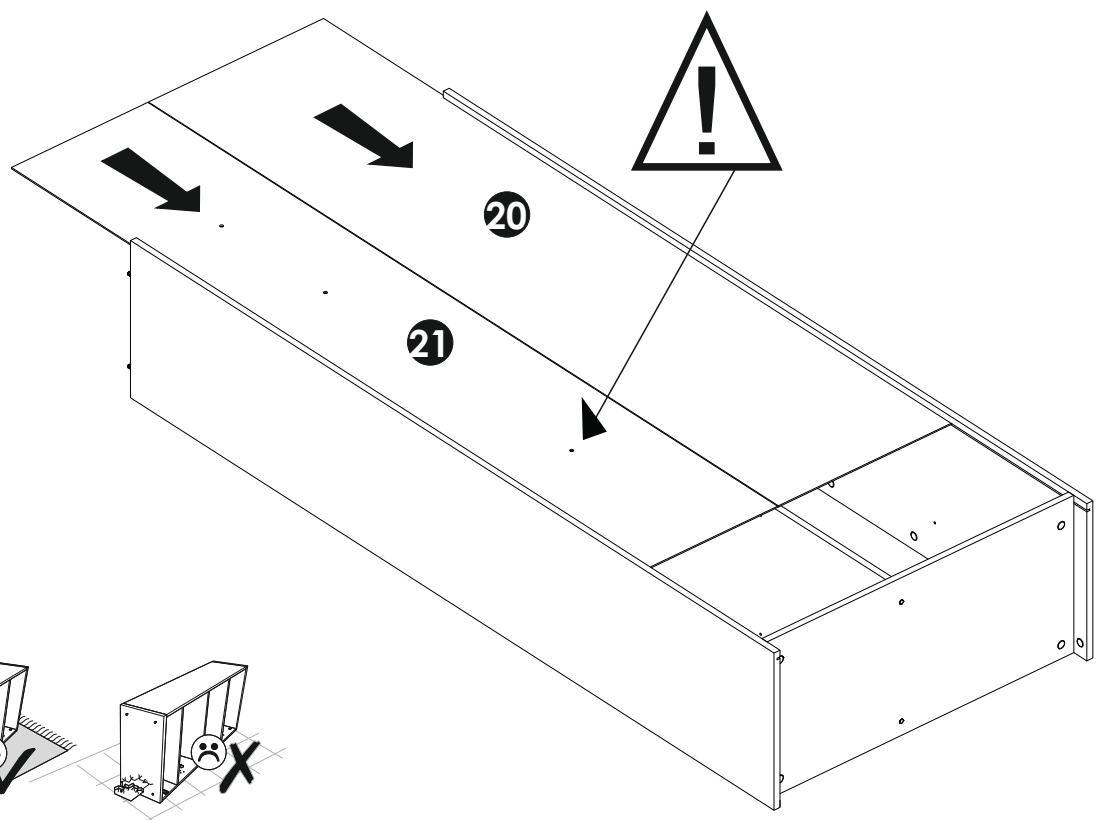

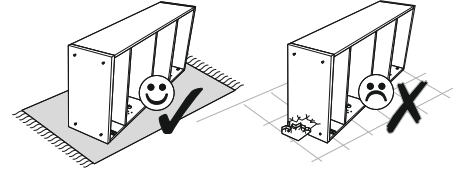



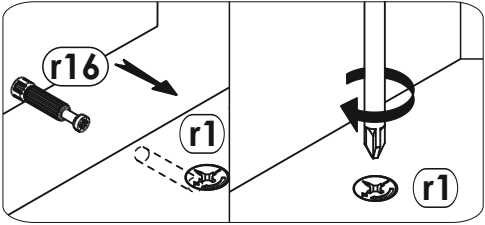
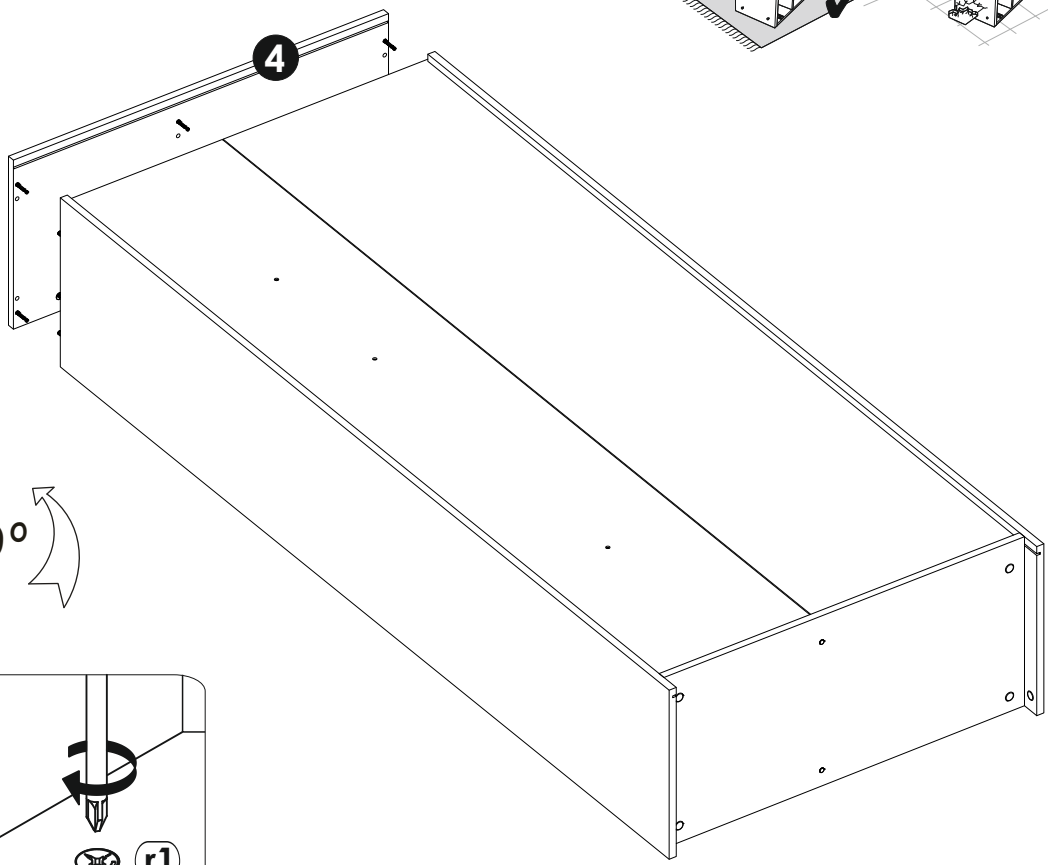

9

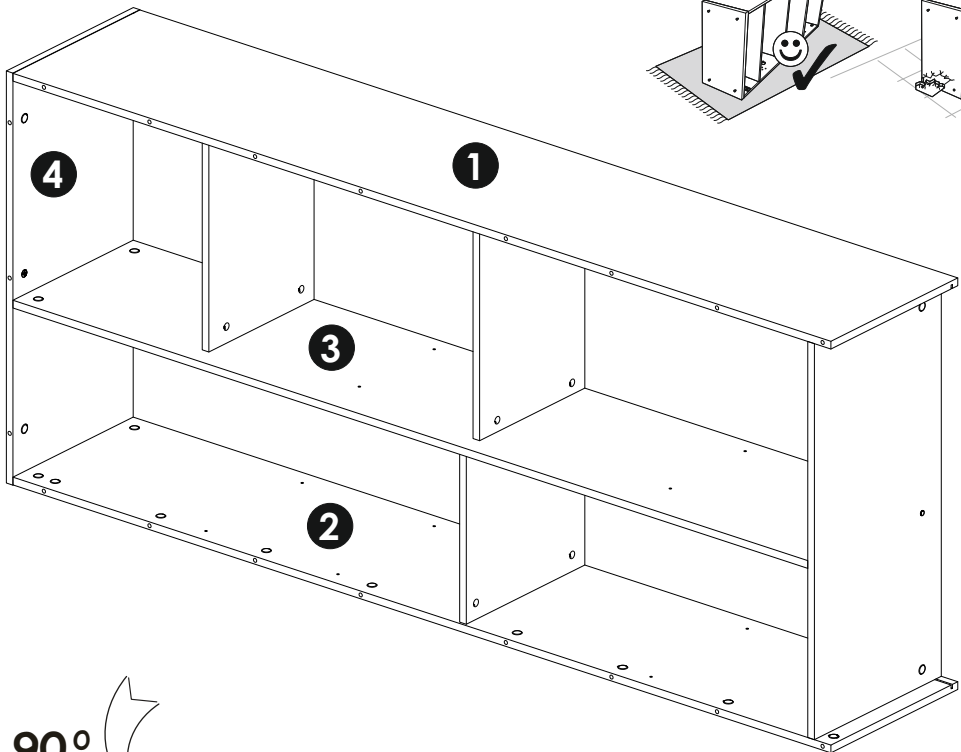
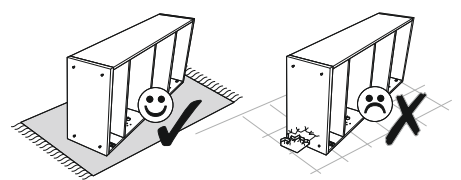



10

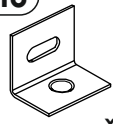

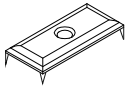

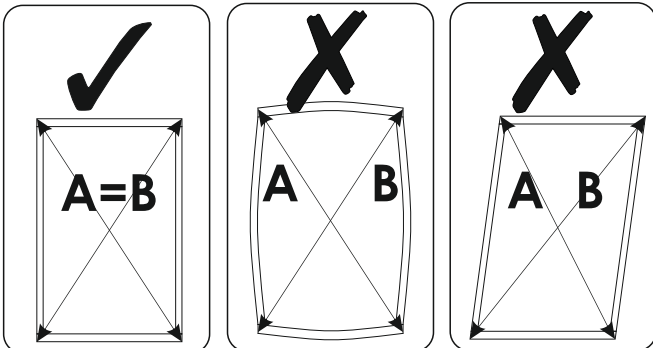
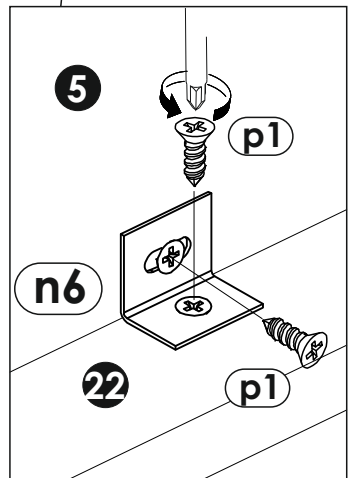
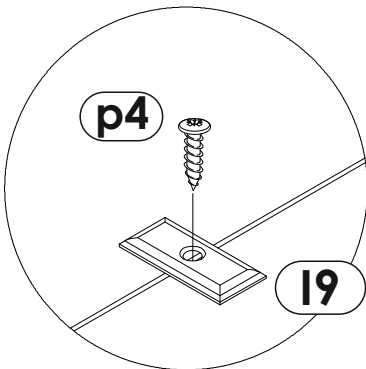
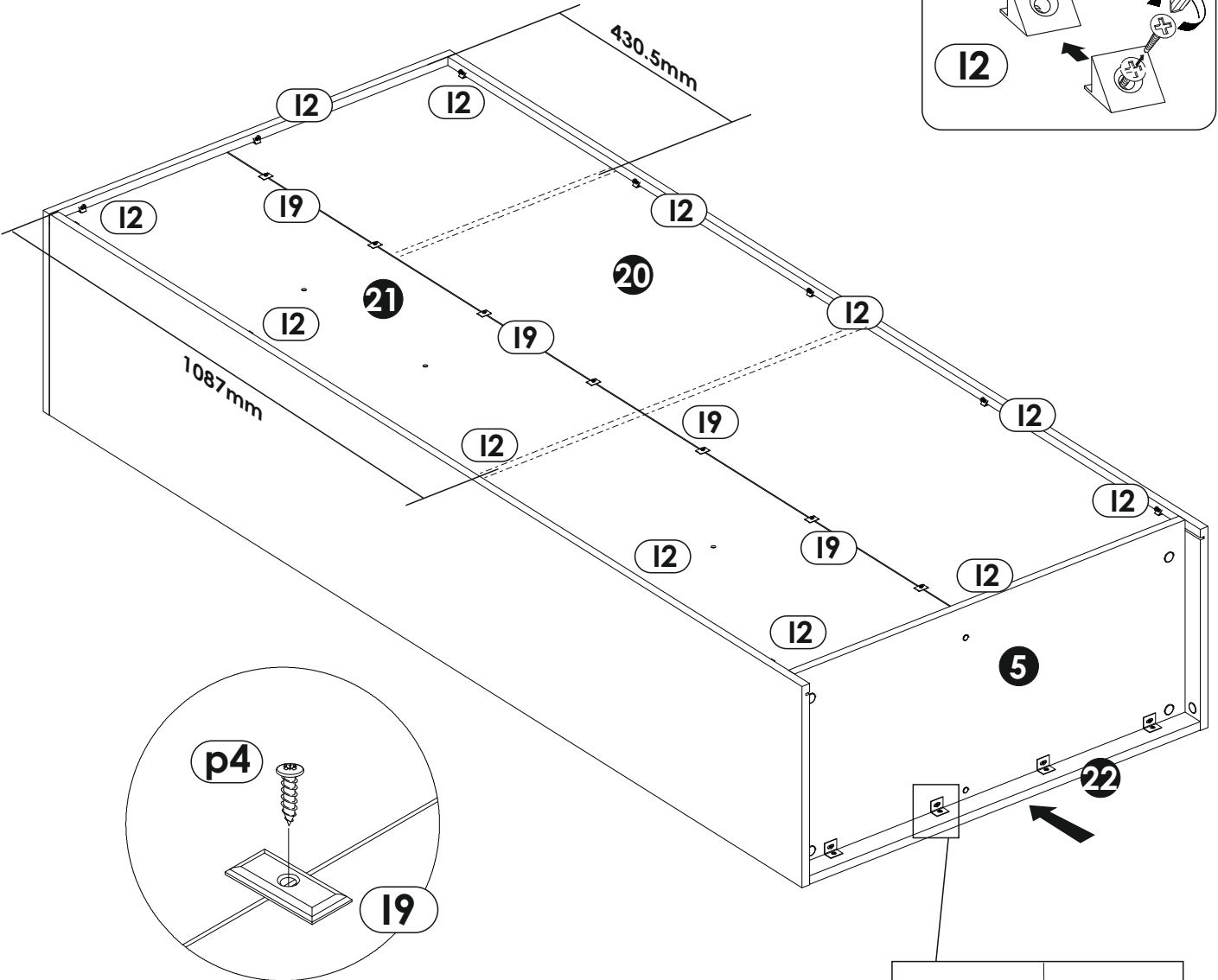
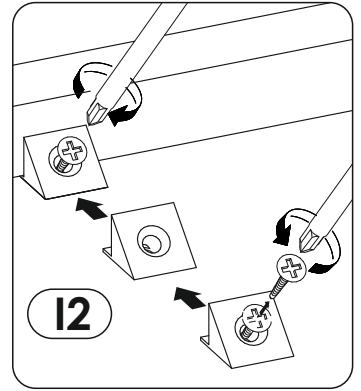
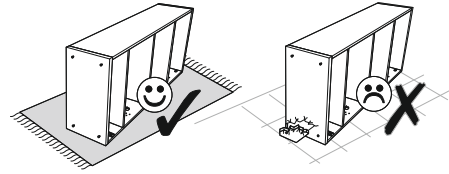

11

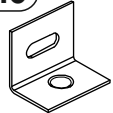
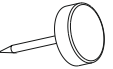
<p>l2</p>  <p>x14</p>	<p>p1</p>  <p>φ3.5x13 mm</p> <p>x8</p>	<p>n6</p>  <p>x4</p>
<p>p4</p>  <p>φ3.5x16 mm</p> <p>x15</p>	<p>l9</p>  <p>x7</p>	

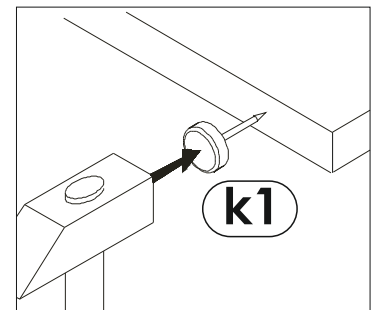
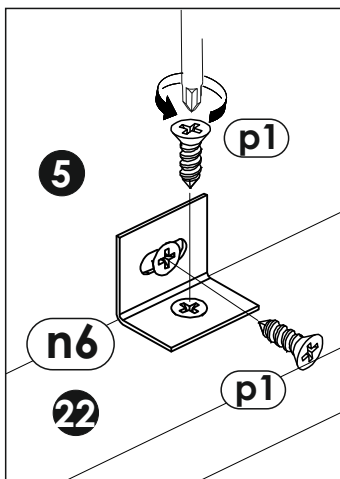
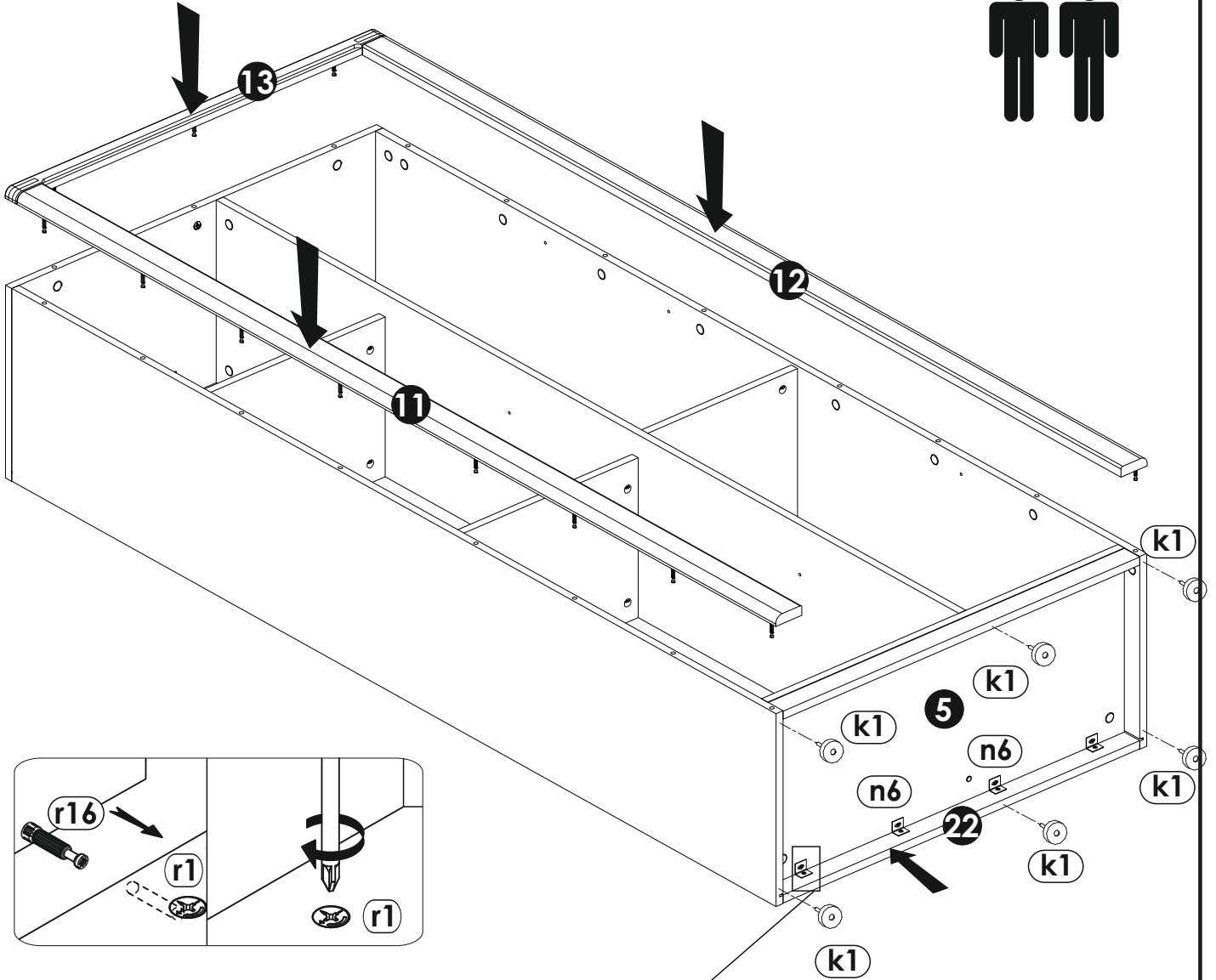
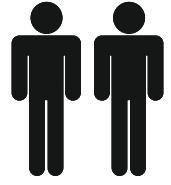
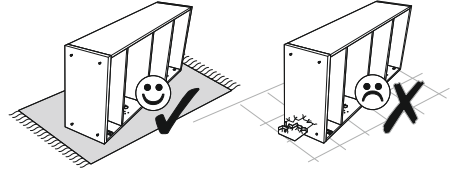



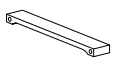

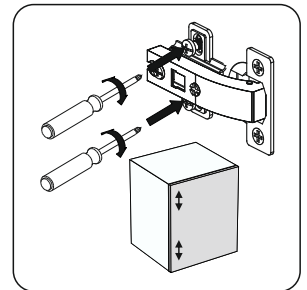
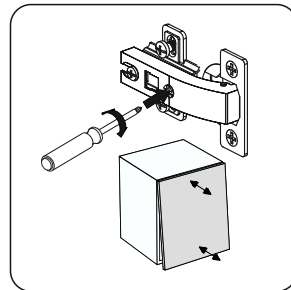
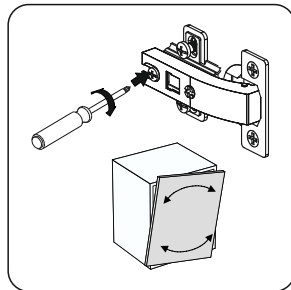
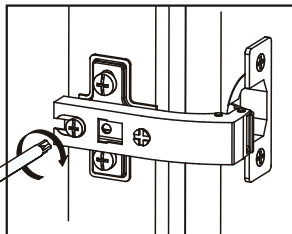
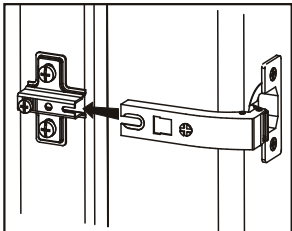
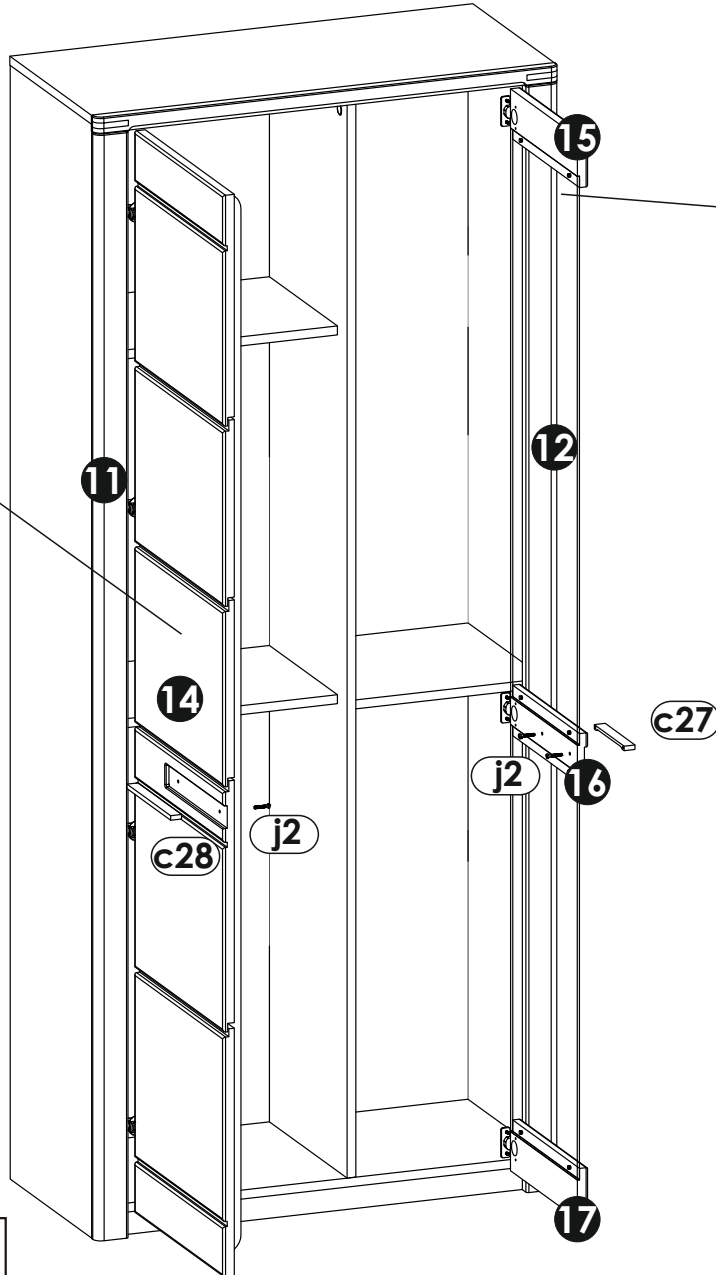
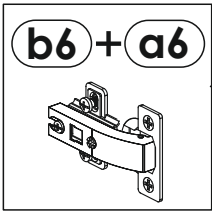
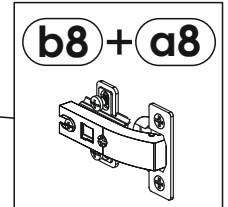
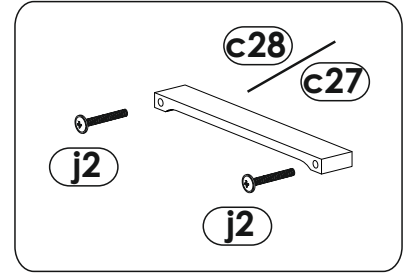

12	p1	n6	k1
	 φ3.5x13 mm x8	 x4	 x6



13	c28	c27	j2
	 192 mm x1	 128 mm x1	 M4x25 mm x4

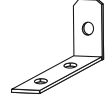

14

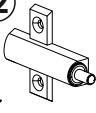
o21  x4	t17  φ8x50 mm x1	n14  x1	p1  φ3.5x13 mm x2	d1  φ5x17 mm x20	s2  x41	n22  x3
---	---	---	--	---	---	---

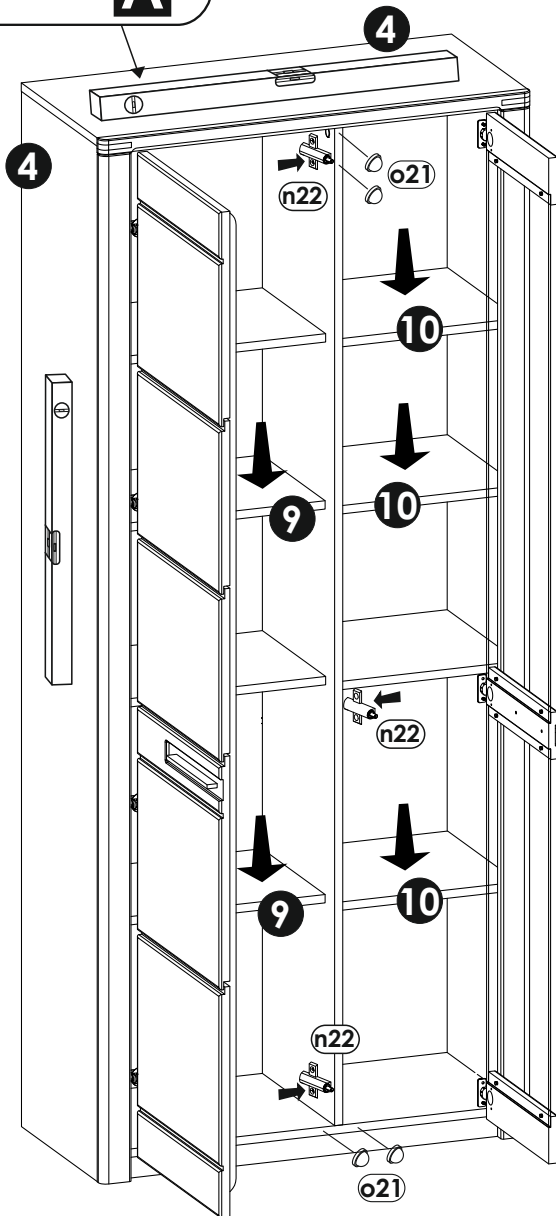
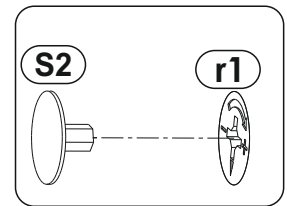
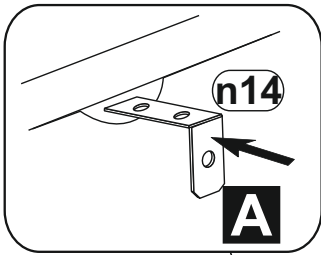
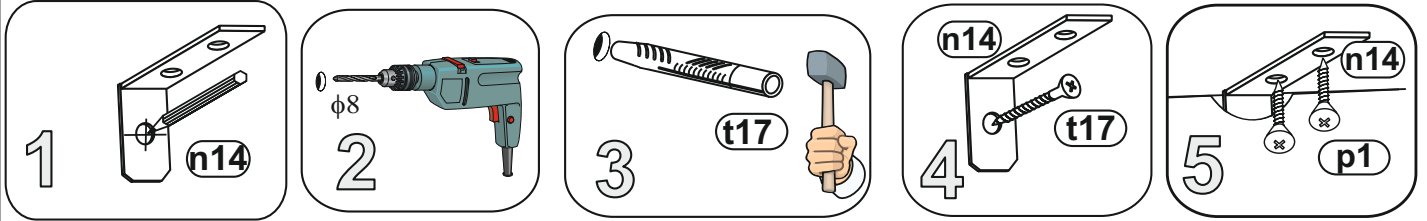

x3

