

# MONTAGEANLEITUNG

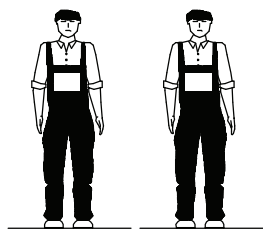

2 Pers.

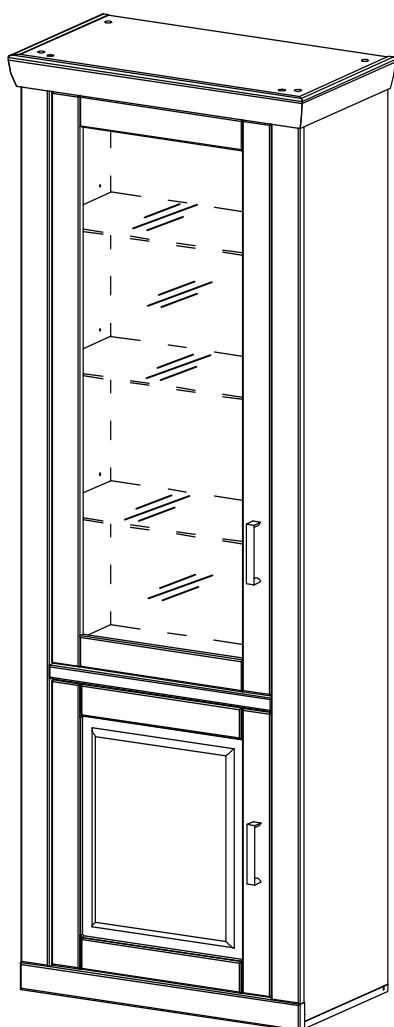
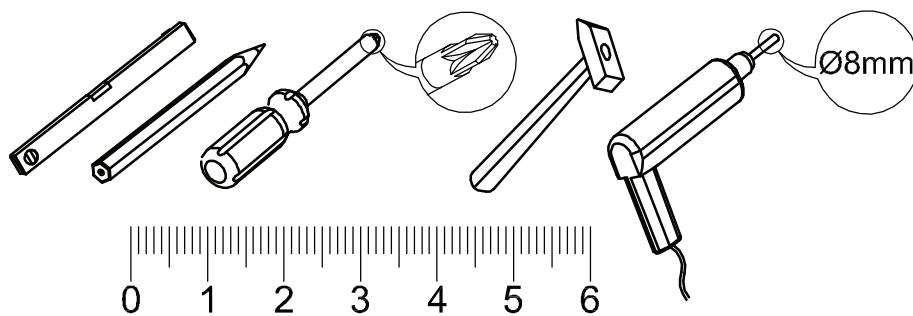

VITRINE L 2T  
ART:BRX1CT10

## BESCHLÄGLISTE

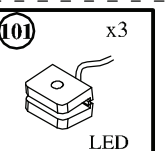
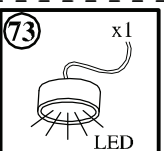
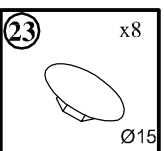
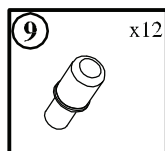
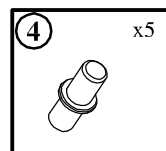
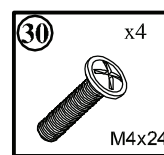
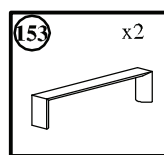
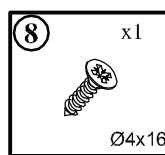
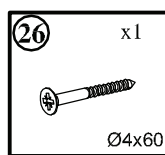
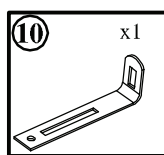
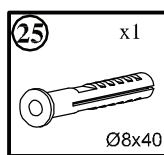
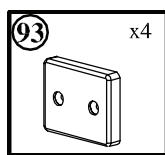
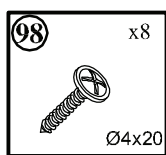

OPTION

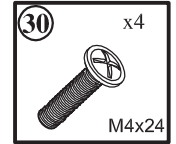
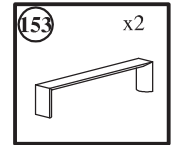
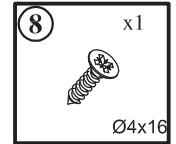
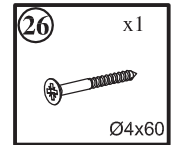
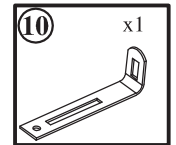
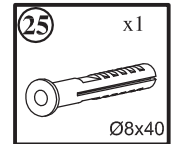
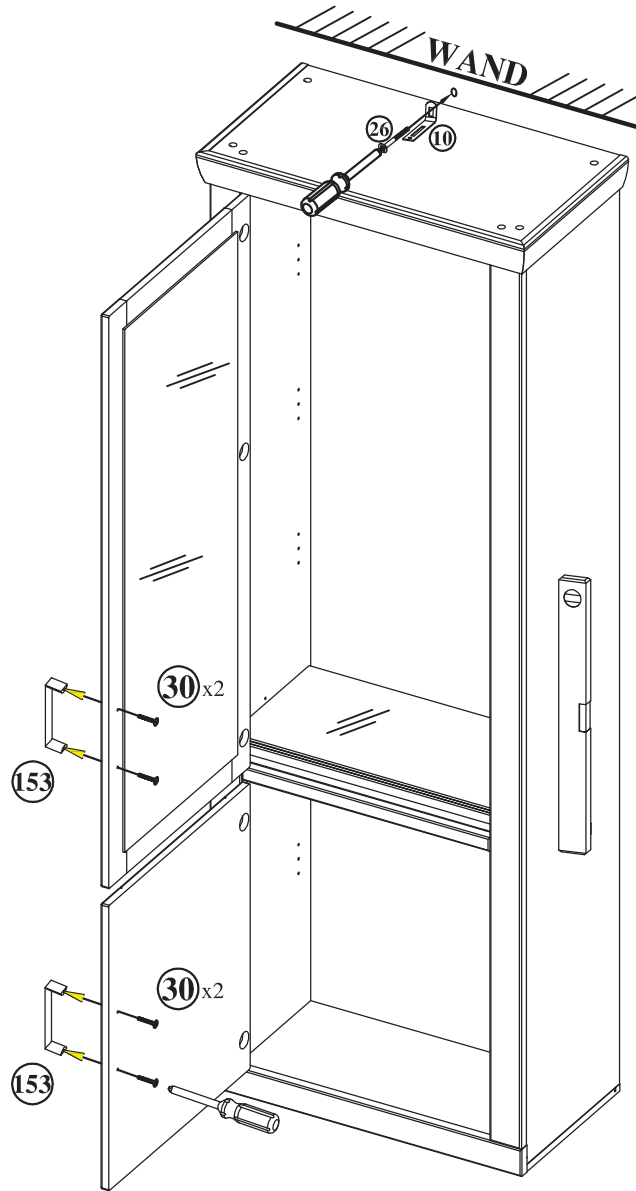
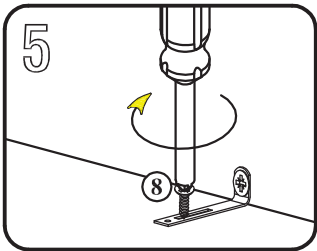
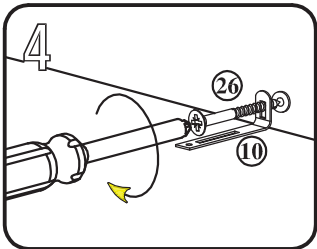
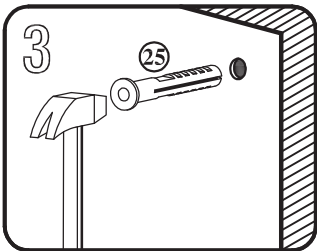
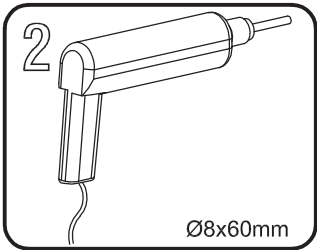
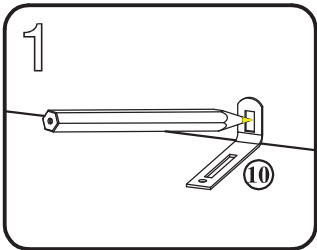
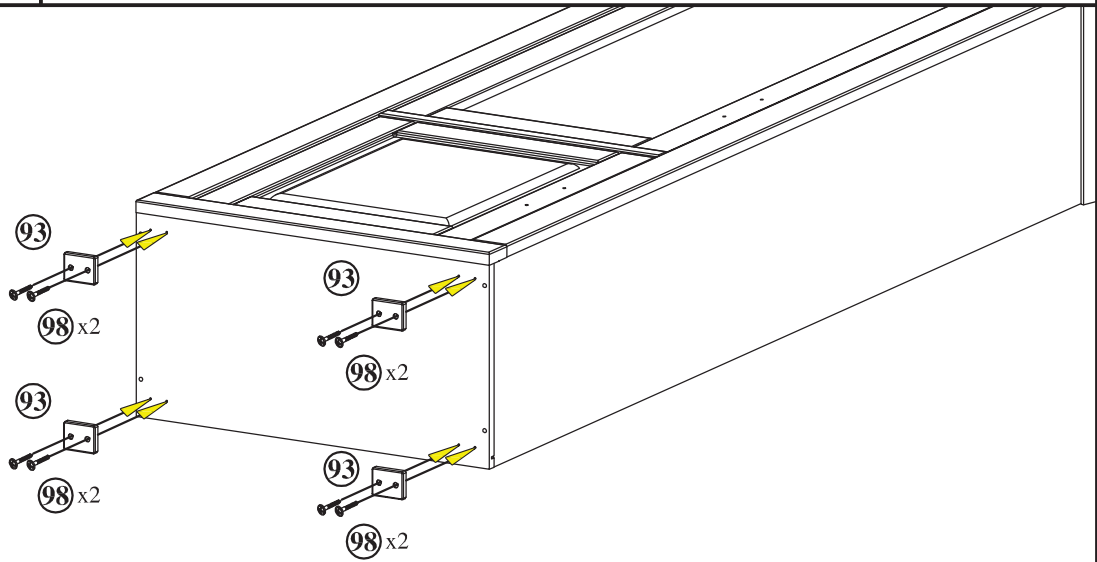
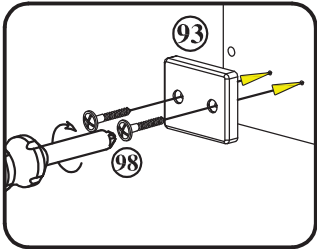
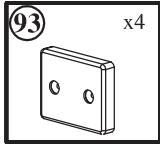
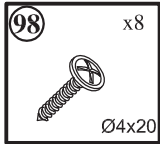

Die beigefügten Dübel zum Aufhängen des Elements dürfen nur bei Betonwänden eingesetzt werden, bei anderen Wandarten müssen entsprechende Dübel zugekauft werden.

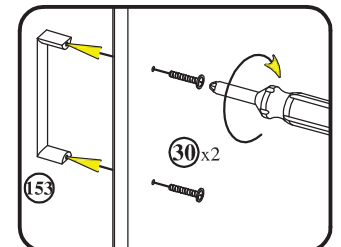

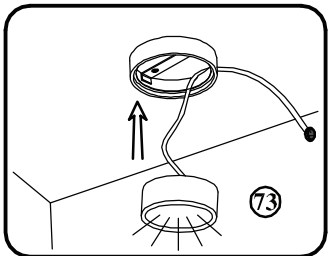
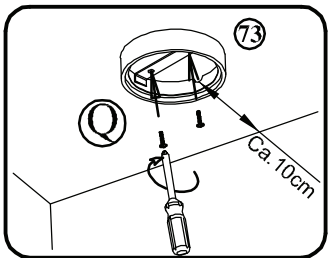
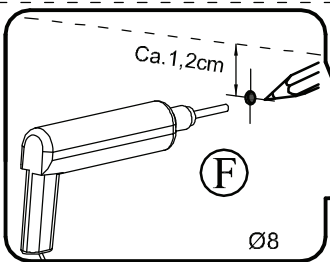
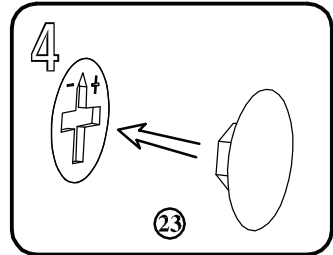
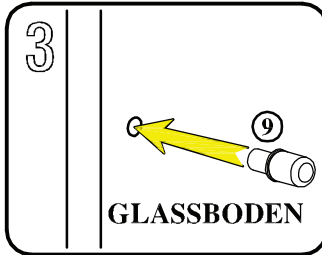
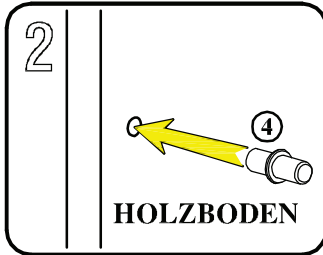
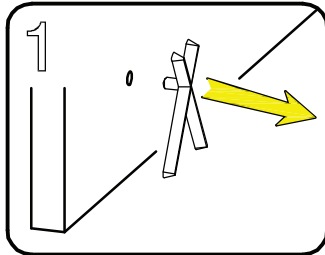
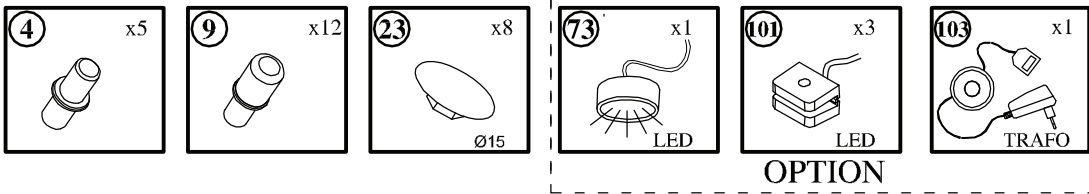

OPTION

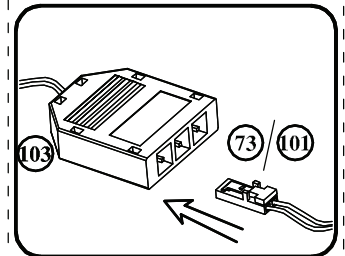
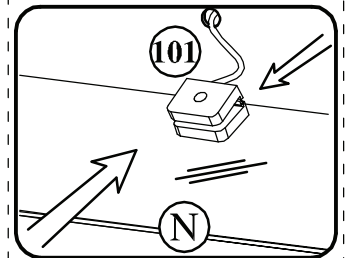
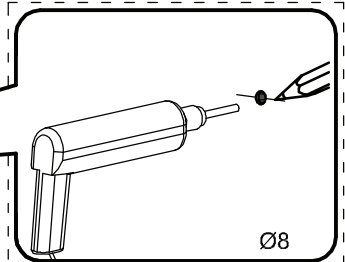
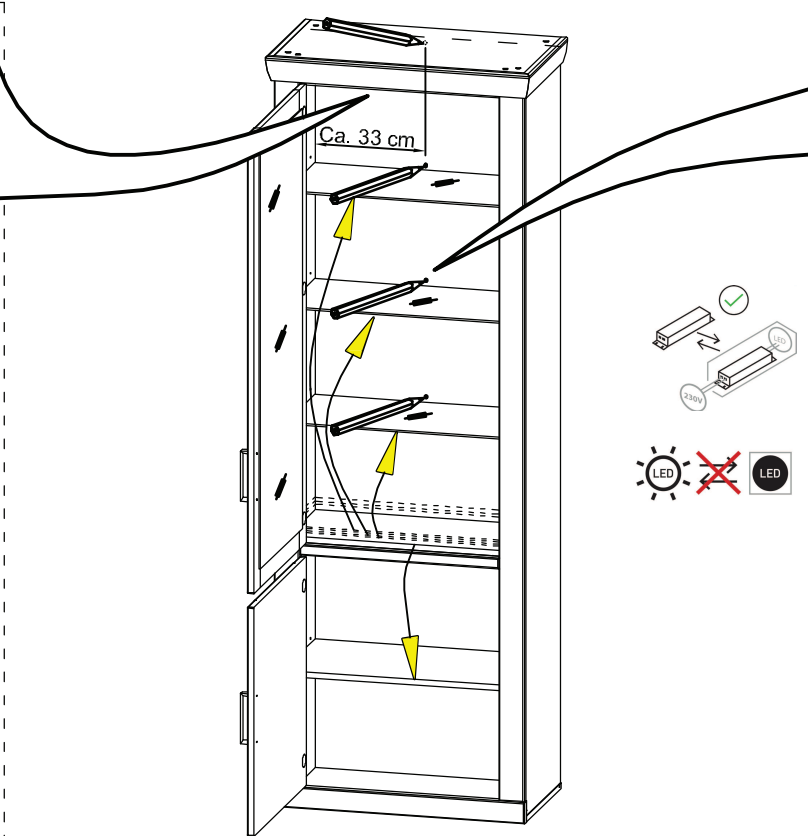

OPTION

a)  
**Fugenverstellung:**  
Befestigungsschraube "A" lockern,  
gewünschte Fuge mit Schraube "B"  
einstellen. Schraube "A" anziehen.

## Verstellmöglichkeiten

b)  
**Tiefenverstellung:**  
Befestigungsschraube "A" lockern,  
Bandarm nach voren oder  
rückwärts verschieben, Schraube "A"  
anziehen, Schraube "B" mit  
einer 1/4 Drehung nach rechts  
arretieren.

c)  
**Hohenverstellung:**  
Befestigungsschraube "C" lockern,  
Hohe einstellen, Schraube "C"  
anziehen.

